

Electric Instantaneous Water Heater

Operation and Installation Instructions



Keep this instruction manual in a safe place once your unit is installed, you may need to refer to it for general instructions or future maintenance.

Please read and follow the installation and operation instructions carefully, to ensure the long life and reliable operation of this appliance.

CONTENTS

Important Safety Instructions	page 2
Product Features	Page 3
Electrical Diagram	page 4
Technical Data	page 5
Product Inner Structure	page 5
Installation Guideline	page 6
Installation Method	page 6
Operation Instructions	page 10
Trouble-Shooting	page 12
Normal Maintenance	page 12
Correct Disposal of this product	page 13
Packing List	page 13

■ Important Safety Instructions

1. The installation must be in compliance with the **National Electrical Code**, your local electrical and plumbing codes.
2. **This appliance must be EARTHED.** (If the model is equipped with plug, it is an electric leakage protection plug).
3. Install or locate this water heater only in accordance with the provided installation instructions.
4. Use this water heater only for its intended use as described in this manual.
5. Contact a qualified electrician to have unit properly installed.
6. This appliance is not intended for use by persons (including children) with reduced physical, sensory, or mental capabilities, or lack of experience and knowledge, unless they have been given supervision or instruction use of the appliance by a person responsible for their safety.
7. This appliance **MUST** be permanently connected to the fixed circuit breaker and it must be installed vertically. **DO NOT** install this appliance near to tinder or strong magnetic field place. Children should be supervised to ensure that they do not play with the appliance.
8. This appliance is **forbidden** to be switch on if you think it may be frozen, as this could result in serious damage to the unit. Wait until you are sure that it has completely thawed out before you switch it on.
9. Please feel the outlet hot water temperature with hand to make sure it is suitable for showering before taking shower to avoid getting scalded.
10. Before connecting pipes to the water heater hoses, it is extremely important to **FLUSH** the pipes to wash away all plumbing paste or residue in the pipes.
11. If there is damage to the wire, you must contact qualified electrician.
12. Run water through the outlet periodically, in order to remove calcium carbonate deposits.
13. The drain-pipe which connected to the water relief valve should be installed continuous downward in frostless environment.
14. The spray head must be descaled regularly.

WARNING: Do not switch on if there is a possibility that the water in the heater is frozen.

■ Product Features

This Mini tankless electric water heater differs from a conventional storage type mini water heaters. It doesn't store hot water. Instead, water is heated instantaneously as it flows through the unit. The powerful heating elements are activated by a flow switch as water is drawn from a hot water faucet connected to the appliance. Due to the absence of stand-by loss, the mini has greater energy efficiency than storage type water heaters. The unit are incorporated with multi-safety devices and will continuously supply hot water as long as the faucet is open.

Besides, the unit has the following features.

1. Tankless, instantaneous heating for on demand hot water, No pre-heating. No stand-by heating loss. energy-saving.
2. High strength ABS splash proof casing, stainless steel heating element.
3. Compact appearance and unlimited supply of hot water.
4. Easy installation, heater can be installed above or under sink.
5. Easy operation, the heater provides hot water with constant temperature.
6. Micro-computer control, Adopting patent heating technology. Water is completely separated from electricity by multi-layers of composite nano insulation material.
7. Over temperature protection: when the outlet water temp. reaches or exceeds 60°C, the appliance will avoid scalding and will start to work automatically once temp. drops to a safe level.

■ Electrical Diagram

Electrical Diagram

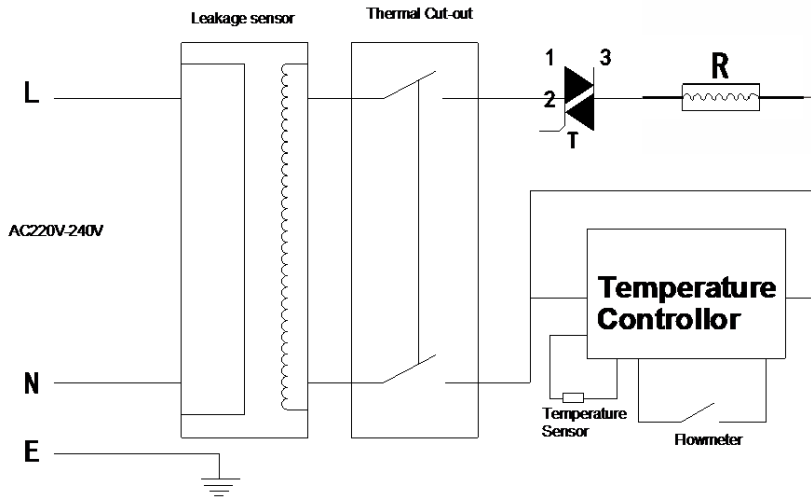

Remark: R:Resistance T: Triac

■ Technical Data

Model		RTEC-04 E03	RTEC-06 E03
Voltage		220V-240V~	
Wattage	W	3500	6500
Rated Current	A	16	29.5
Min. required circuit breaker	A	16	40
Min. wire size	mm ²	1.5	4
Min. water flow to activate unit	L/min	1.5	
Frequency	Hz	50 – 60	
Working pressure	MPa	0.02-0.6	
Weight	kg	1.5	
Product Dimensions	mm	198x160x98	
Water connections		G1/2"	

■ Product Inner Structure

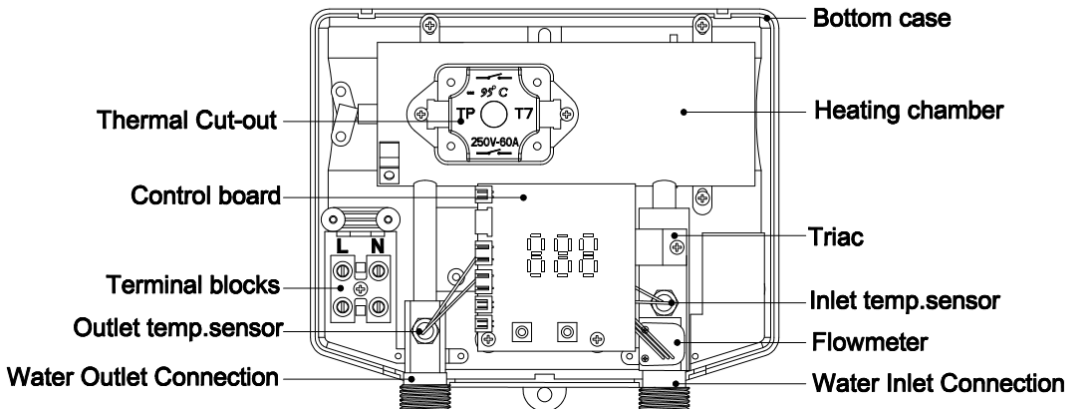

■ Installation Guideline

The installation must be in compliance with the National Electrical Code, your local electrical and plumbing codes.

1. Make sure the appliance is intact, and the fittings are complete.
2. Check valve is required to be installed at the water inlet.
3. Please make sure the main power supply, water pressure, grounding condition, amperage/current and wire reach the standard of installation requirement.
4. The appliance must be connected to properly grounded dedicated branch circuits of proper voltage rating. Ground must be brought to the “ground” at the circuit breaker panel.
5. This appliance **MUST** be permanently connected to the fixed circuit breaker. If you don't use the heater, please switch off the circuit breaker.
6. **DO NOT** install this appliance near to tinder or strong magnetic field place. The appliance can be installed above or under the sink, and unit must only be mounted in a VERTICAL position near by the water fittings.

■ Installation Method

The Mini tankless electric water heater can be used for hand washing, kitchen and it can be installed above or under the sink.

●Mounting the unit

Locate an appropriate place on a section of wall as above mentioned.

Fig 1 → Front and back of the appliance

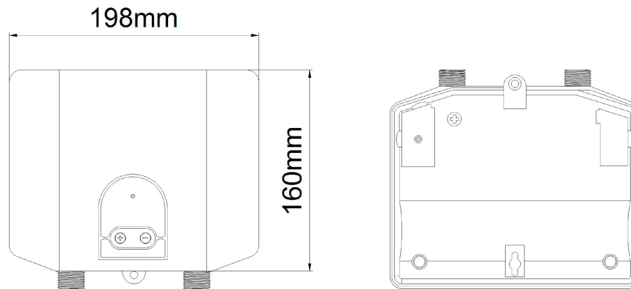

Fig 2 → Drill two holes of 6.00mm diameter: if you install the heater upright above the sink, the distance between every two holes is 146mm; if you install the heater upside down under the sink, the distance between every two holes is 139mm. Put plastic anchor in the holes

Fig2-A: Upward Installation

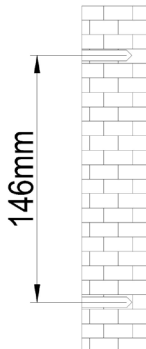

Fig2-B: Upside down Installation

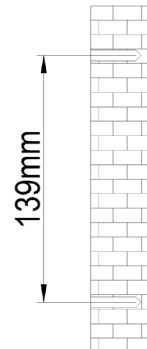

Fig3 → For Upright Installation, nail in the floor in upper hole (Fig3-A), For Downward Installation, nail in the floor in lower hole (Fig3-B), fix the appliance on the wall with the below nail.

Fig3-A: Upward Installation



Fig3-B: Upside down Installation

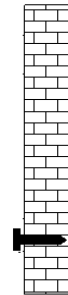

Fig4 → Fix the appliance on the wall with the fixed nail;

Fig4-A: Upward Installation

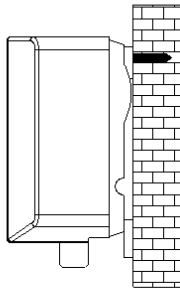

Fig4-B: Upside down Installation

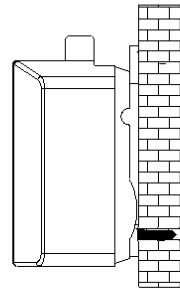

Fig5 → Then fix the appliance with nail in another hole, to make sure the whole appliance is installed on firm.

Fig 5-A: Upward Installation

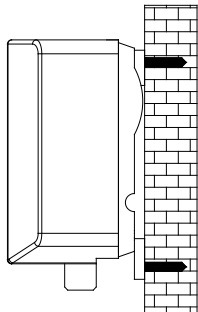
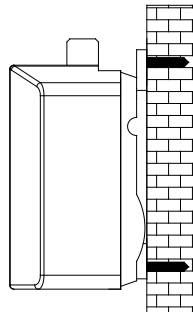

FIG 5-B: Upside down Installation



●Water Connections

1--- All water pipe must comply with national and applicable state and local water pipe codes.

2--- No matter install the appliance upright or handstand, Please connect the inlet connection (blue arrow points to) to the cold water inlet pipe; connect the outlet connection (red arrow points to) to the hot water outlet pipe .

3---The unit should be connected directly to the main water supply. Flush pipe with water to remove any debris or loose particles. Following pics is for your reference.

4, It is required that use G1/2" water connections to fit the appliance. Please connect the inlet and outlet pipe in perspective. Following pictures are for your reference.

5, Please remember to install rubber seal rings at the connections. When all water connections are completed, check for leaks and take corrective action before proceeding.

Fig 6-A: Upward Installation

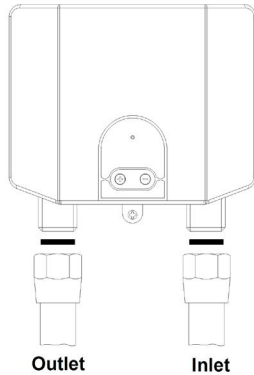
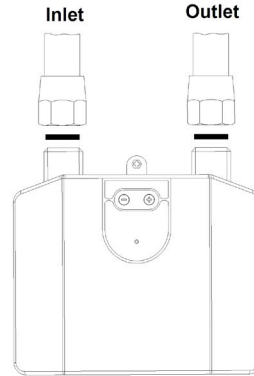

FIG 6-B: Upside down Installation



● **Electrical connection**

- 1, All electrical work must comply with national and applicable state and local electrical codes
- 2, All unit must be connected to a properly grounded dedicated branch circuit of proper voltage rating.
- 3, While fed the cable to terminal blocks/Circuit Breaker, please make sure the metal wire ends and the terminal blocks to touch completely. Then tighten the screws up to make sure the full current can go through.
- 4, Before beginning any work on the electric installation, be sure that main breaker panel switch is OFF to avoid any danger of electric shock, all mounting and plumbing must be completed before proceeding with electrical hook-up.

■ **Operation Instructions**

Model (RTEC-04 E03, RTEC-06 E03)



- 1--- Turn on the circuit breaker to bring electrical power to the unit. The LED digital display screen will light.
- 2--- Turn on the water faucet for a few minutes until water flow is continuous and all air is drained from water pipes. The unit must be operated after the breaker is turned on.

3--- After the unit is supplied with power, please turn on the water and then the appliance will start work. The min water flow to activate the unit is 1.5L/min.

4--- Turn off the water flow, the appliance will stop working. It is not necessary to turn off the heater by pressing any key on front panel.

5--- Press  to adjust the setting temperature between 30°C -55°C, Temperature setting will cycle among 30°C-55°C -30°C, single press the key, the setting temperature will be up 1°C, only in the working condition, the press key is available to adjust the temperature. The default setting temperature is 55°C.

6--- Press  continuously for 3 seconds, the setting temperature will be circularly setup among 38°C -42°C -55°C -42°C -38°C.

7---  is the function key, If you need to install the unit upside down, Please press  and hold for 3 seconds, the temperature display Arabic numerals will rotate 180°.

8--- There is overheat protection function for the appliance, while the outlet temperature reaches 60°C, the appliance will decrease the power level automatically, only after the hot water temp. drop to 53°C, it will recover to work. In this state, you should reduce the setting temperature.

9--- There is real-time leakage detection function, while there is a leakage, the appliance will stop working automatically.

10--- Please check hot water with hand before using. If the unit will not be used in winter, drain out water completely so that the heater will not be frozen.

- Please periodically clean inlet strainer and the shower to keep a free water flow.

■ Trouble-shooting

Problems	Possible Cause	Corrective Actions
1. Inlet and outlet fittings leaking	A. Fittings not tight B. Rubber washer worn-out	A. Tighten fittings. B. Replace rubber washer.
2. LED no signal	A. Power not connected. B. LED damaged.	A. Connect power to the unit. B. Change LED.
3. Functional keys not working	A. No water out from shower. B. Water pressure too low. C. Key or PCB damaged.	A. Open valve to get water. B. Open valve to get pressure. C. Replace key or PCB.
4. Water too hot	A. Too high temperature set. B. Water flow too low.	A. Set a lower temperature. B. Increase inlet water flow.
5. Water too cold	A. Low temperature set. B. Water flow too high.	A. Set a higher temperature. B. Reduce water flow.
6. Low water flow	Inlet strainer or shower clogged.	Clean strainer and shower.

■ Normal Maintenance

Note: Do not attempt to repair this water heater yourself, call a service person for assistance. Before these operation, the power supply needs to be shut off. The unit requires minimal maintenance. However, to ensure consistent water flow, the following is recommended:

- 1, Periodically remove scale and dirt that may build up at the aerator of the faucet or in the shower head.
- 2, There is a built in filter screen at inlet connection which should be cleaned from time to time. Please turn off the water flow before doing this.

■ Correct Disposal of this product



This marking indicates that this product should not be disposed with other household wastes throughout the EU. To prevent possible harm to the environment or human health from uncontrolled waste disposal, recycle it responsibly to promote the sustainable reuse of material resources. To return your used device, please use the return and collection systems or contact the retailer where the product was purchased. They can take this product for environmental safe recycling.

■ Packing List

Item	Unit	Quantity
Electric Water Heater	Unit	1
Rubber washers and screws	Set	1
Operation and Installation instruction	Copy	1
SASO energy label	Piece	1

EX07200-119