

Limited Warranty

RHEEM MANUFACTURING COMPANY (SINGAPORE) PTE LTD, representing Thermatrac Water Heater will guarantee the heater for a period of twelve months from date of original installation and operation against defective faulty materials and workmanship.

RHEEM MANUFACTURING COMPANY (SINGAPORE) PTE LTD will warrant to replace any part or parts which prove to have been defective and which have not been misused or carelessly handled. We reserve the right to decline responsibility where installation has been incorrectly carried out and not in accordance with the manufacturer's instructions, which accompany each heater.

Please contact heater distributor in your locality to verify against claims for warranty and/or regular heater servicing.

Rheem Manufacturing Company (Singapore) Pte Ltd

Revision Date: 2018 Dec.



Instruction Manual Storage Water Heater



MODELS:

- ★ RC PLUS 10
- ★ RC PLUS 15
- ★ RC PLUS 30

Please Read This Manual Carefully Before Installation and Operation
Rheem Manufacturing Co. Singapore Pte Ltd

Content

Thank you for choosing a Rheem storage water heater.

Please read this manual carefully before installation and usage. In particular, please pay special attention to the safety aspects. The installation must be undertaken by a qualified person. Please leave this manual with the houseowner upon the completion of installation and commissioning.

1. Features	2
2. Safety	3
3. Technical Data and Dimensions	5
4. Installation and Connection	6
5. Operation	8
6. Maintenance	9
7. Common Breakdowns and Remedies	9
8. Packing List	10
9. Limited Warranty	11

Trouble shooting chart

Breakdowns	Possible Causes	Remedies
The failure of pilot lamp	<ol style="list-style-type: none"> 1) Power off or loose electrical connection 2) Interconnecting wiring damaged 3) Pilot lamp damaged 4) Over Temp. controller open 	<ol style="list-style-type: none"> 1) Check for correct voltage at ELCB 2) Call electrician 3) Call electrician 4) Call electrician
No hot water flowing out	<ol style="list-style-type: none"> 1) Cold water inlet tap is shut off 2) Pipes are blocked 3) Water supply is cut off 	<ol style="list-style-type: none"> 1) Turn on the inlet tap 2) Dredge the pipe by plumbers
Water is not hot	<ol style="list-style-type: none"> 1) Electric plug is off at the socket 2) Terminal block is damaged 3) ELCB has operated. Element has failed 4) Over Temp. controller open 5) Temperature set is too low 6) Thermostat is damaged 7) Water Heater is working 	<ol style="list-style-type: none"> 1) Plug in 2) Call electrician 3) Call electrician 4) Call electrician 5) Raise the set temperature 6) Call electrician 7) Please wait for a while
Sound from the water heater and pipelines	<ol style="list-style-type: none"> 1) Heating up noise 2) Abnormal sound in pipeline when mains pressure is not stable. 3) Scaling on elements 	<ol style="list-style-type: none"> 1) Normal 2) Normal. Close the cold water inlet tap for a while. 3) Call for a serviceman
Water discharge s from pressure relief valve	<ol style="list-style-type: none"> 1) Expansion of water during heating up 2) Valve is blocked by foreign materials 3) Excessively high cold water pressure 	<ol style="list-style-type: none"> 1) Normal 2) Operate valve lever to remove dirt deposit 3) Reduce incoming water pressure
Not enough hot water	<ol style="list-style-type: none"> 1) Undersized heater 2) Temperature setting too low 3) Insufficient water pressure 4) Too many multiple outlets in use 	<ol style="list-style-type: none"> 1) Consult heater supplier 2) Increase temperature setting 3) May have to use booster pump 4) Consult heater supplier

Packing List

Item	Description	Qty.
1	Electric storage water heater	1
2	Instruction manual	1
3	Expansion bolt	2
4	Pressure relief valve	1
5	Mounting bracket	1

- In normal condition, the cold water tap should remain open.
- It is normal for the pressure relief valve to release a small amount of hot water during the heating cycle due to expansion.
- Always open mixer to cold water first and slowly adjust to warm to avoid scalding.
- When water supply is interrupted, the main power supply to the heater should be switched off to avoid dry firing.

Water Temperature Setting

The “LOW” mark on rim of the temperature dial represents an approximate water temperature of 20°C. The “HIGH” mark represents an approximate water temperature of 75°C. To adjust the temperature, turn the temperature dial to the position you want.

Shut Down the Water Heater

The water heater should be shut off for service and during vacation. Shut off the water heater according to following steps:

- Isolate power supply source
- close the cold water valve to heater

Maintenance

Pressure Relief Valve

- Operate the pressure relief Valve at least once every six months to remove lime deposits and verify that it is not blocked. This is done by lifting the lever at the pressure relief valve for a few second. If there is no water flowing out, please call for a serviceman.
- Damage to the heaters due to blockage in the overflow pipe will void the warranty.

Common breakdowns and remedies

Over-temperature protection

If over-temperature occurs (when water temperature reaches 93°C), the Hi-limit will cut off the electric power. If the over-temperature protection activates, the water heater can not be used until the problem is solved and the switch of the over-temperature protection is reset manually. Please contact a service technician to undertake any repair.

Features

- Deep drawn tank construction with single circumferential weld – design to enhance protection against tank leakage
- Water inlet whirl flow for rapid mixing
- Mains pressure tank design allows true multi point hot water delivery
- Adjustable thermostat allows safe automatic temperature regulation
- Manual reset over temperature protection or cut out
- Pressure relief valve (PRV) with built in check valve
- Water connectors internally enameled minimize corrosion
- Dial type thermometer for temperature display
- Pilot lamp for ON/OFF indication
- Exclusive blue vitreous enameled lining promotes long lasting tank life.
- Thick CFC free polyurethane for superior heat retention
- Magnesium anode for additional tank protection against corrosion
- Incoloy sheathed immersion heating element resists dry firing
- Heater jacket is of epoxy coating for superior weather resistance
- Temperature set point adjustment dial within easy reach
- Integral strong wall mounting bracket and expansion bolts

Tested and approved to International Safety Standard IEC 60335-2-21

Safety

- This appliance is not intended for use by persons (including children) with reduced physical, sensory or mental capabilities, or lack of experience and knowledge, unless they have been given supervision or instruction concerning use of the appliance by a person responsible for their safety.
- Children should be supervised to ensure that they do not play with the appliance.
- If the supply cord is damaged, it must be replaced by the manufacturer, its service agent or similarly qualified persons in order to avoid a hazard.
- Heater should be installed near a floor trap to drain off water due to expansion or other leakages.
- Power supply: 220-240VAC/single phase/50HZ and 220V -230VAC/single phase /60HZ.
- kWh meter, electric cables and terminal block must comply to rated electric current and to local electrical code.
- Appliance earthing requirement in accordance to our recommendation or to local code to be strictly followed.
- Power supply should not be turned on until the tank is full of water.
- Started water temperature should be mixed with cold water to a suitable shower or bath temperature before use. Beware if hot water scalding!
- Pressure relief valve with built in check valve must be installed on cold water inlet piping of water heater. When internal water pressure reaches 0.8MPa, small amount of water may be release. Manually operate the pressure relief valve once every six months to clear any lime deposit and to verify that drain tube or pipe is not blocked.
- Drain pipe must remain open to atmosphere. A blocked drain pipe can cause heater failure and void any warranty.
- Drain pipe connected to pressure relief nozzle (hose barb fitting connection) is to be installed in a continuously downward direction and in a frost-free environment.
- Before service or maintenance work can be carried out, power supply must first be turned off.
- During normal heater operation, small amount of water may be released from pressure valve drain due to expansion,. This is normal. (diagram 1)
- Only use original replacement parts to avoid any equipment malfunction or breakdown.

Water in the heater can be drained by following steps:

- ◇ turn off the power supply

A pressure relief pipe must be fitted for the water discharge. The pipe from the pressure relief valve to the floor trap should be as short as possible.

Connection—Electrical

Do not turn on power supply to the water heater until the water heater is filled with water and a satisfactory megger reading is obtained.

- Electrical wiring works must be undertaken by a qualified electrician.
- The water heater is rated for single phase 220-240VAC/50Hz and 220V~230VAC/60Hz.
- The heater must be permanently connected to the electricity supply through a double pole linked switch having a contact separation of at least 3 mm in all poles incorporated in the circuit and out of reach from the person using the shower.
 - a) The appliance must be earthed.
 - b) All wiring must conform to local requirements. If in doubt, please consult a qualified electrician.

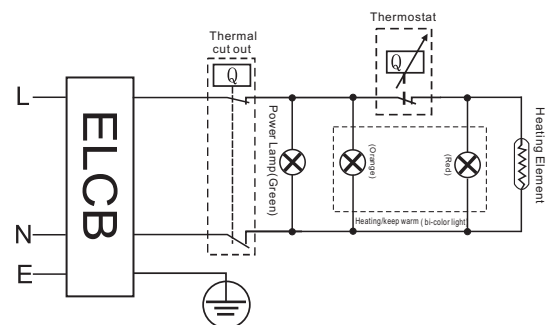

Diagram 7 Wiring diagram

Operation

Filling the Water Heater

- Open one of the hot water mixer taps.
- Open the cold water tap to the water heater.
- When water flows out of the hot water mixer, it means that water heater is completely filled.

Warnings: Power must not be switched on until the water heater is filled with water. There will be NO WARRANTY for dry firing.

Putting Heater in Use

- Switch on power. The water heater operates on/off automatically. The pilot lamp can indicate the status of heating cycle.
- Power lamp will be green when power is turn on. During the heating process, the heating lamp will become red and when it ready, it will become orange.

If the mains pressure is too low, the amount of hot water delivered to multiple points will be unsatisfactory. A booster pump may be used to increase supply pressure. A pressure-limiting valve is suggested to be fitted if the main pressure exceeds the rated maximum pressure.

Diagram 5

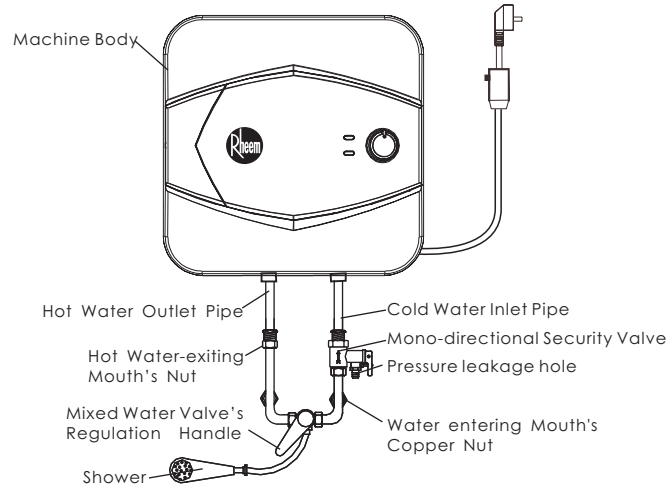
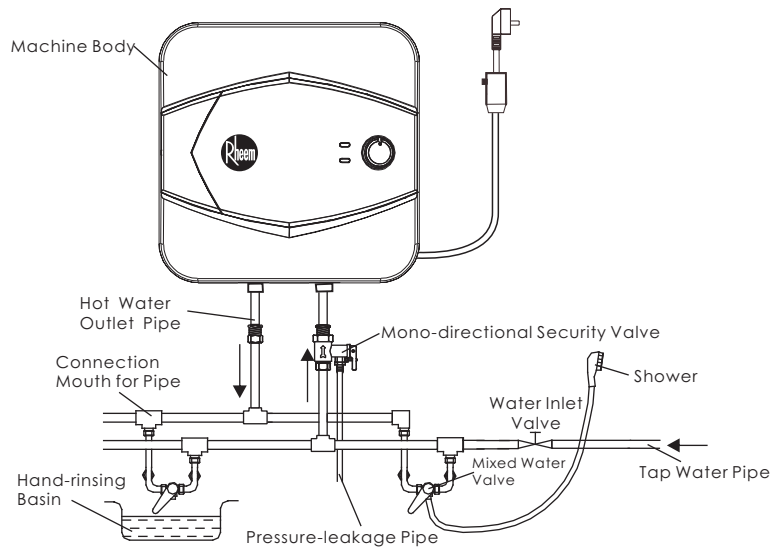

Diagram 6



- Pressure relief valve drain
- ◇ turn off incoming water supply
- ◇ turn on one hot water faucet
- ◇ remove screw on lever, lift it to horizontal position. Water will drain off from heater. (diagram 2)
- ◇ Reverse procedures to fill up heater again.

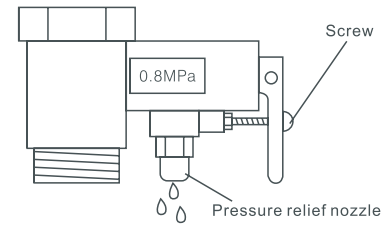

Diagram 1

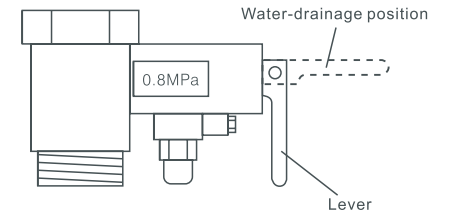
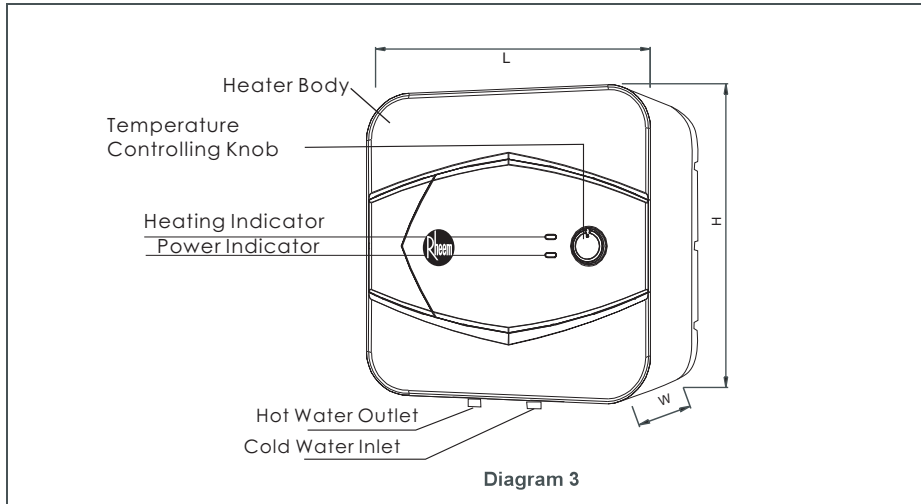

Diagram 2

Technical Data and Dimensions



Model Number			RC PLUS 10	RC PLUS 15	RC PLUS 30
Rated Storage	L		10	15	30
Rated Power	kW		0.25kW/220V	0.35kW/220V	0.50kW/220V
Rated Electric Current	A		1.13A/220V	1.59A/220V	2.27A/220V
Length	L	mm	365	395	445
Height	H	mm	365	395	445
Width	W	mm	293	338	383
Power			220 - 240V ~ /50Hz		
Max. Temp. Setting	℃		75		
Pressure Relief valve set	kPa		800		
Pipe Sizes for Inlet and Outlet			1/2" / 15 BSP		
Operating Weight	kg		18	25	37.8
Shipping Weight	kg		9.5	11.5	14.8

■ Due to product improvement, please check that installation manual has been updated.

Installation and Connection

Choose where to install

- The water heater must be installed indoor.
- The wall must be strong enough to support heater.
- The heater is to be installed near to points of use.
- Ensure that sufficient space is available for servicing.
- There must be a floor trap near installation point for the heater drain pipe.
- Water heater/power switch/electric leakage protector should be protected against ingress of water.

Installation

- Mark the drilling position for locating expansion bolts on the wall as shown in diagram 4.
- Drill holes on the wall using a drill bit (do not damage the electric cable and pipe work inside the wall), then screw in and fasten expansion bolts and bracket. The bracket must be horizontal.
- Hang up the heater. Check that installed heater is level.

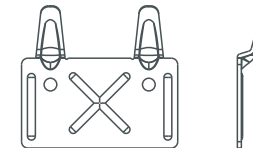

Diagram 4

Connection—Plumbing

■ Pipe Material

The pipes connecting to the inlet and outlet of the water heater must be strong enough to withstand water pressure up to 1.40MPa.

■ Pipe Size

1/2" (15mm) pipes are to be used for cold water inlet and hot water outlet.

■ Connection

Both the inlet and outlet are located at the bottom of the water heater, with the left connection being outlet and right connection being inlet. (Blue for inlet and Red for outlet.)

Please refer to diagram 5 for single point usage for existing piping.

Please refer to diagram 6 for hot water multi point use.

As the temperature is high at the outlet, a mixing valve which mixes hot water with cold water is suggested to be fitted. If the outlet tap is not close to the water heater, thermal insulation material is recommended to insulate the hot water pipe so as to reduce heat loss.