

# Eemax™

## INSTALLATION INSTRUCTIONS & HOME OWNERS MANUAL

### AUTOBOOSTER™

#### **IMPORTANT SAFETY INFORMATION**

When installing or using any high voltage electrical appliance, basic safety precautions should always be followed. Under no circumstance should you attempt to clean, install, inspect, repair, disassemble or otherwise service this water heater, without first shutting off all power to the unit directly at the circuit breaker box. **SERIOUS BODILY INJURY OR DEATH COULD OCCUR IF YOU IGNORE THIS WARNING.**

**IF ASSISTANCE IS NEEDED, A LICENSED AND QUALIFIED PLUMBER AND ELECTRICIAN IN ACCORDANCE WITH ALL APPLICABLE NATIONAL, STATE, PROVINCIAL, AND LOCAL PLUMBING AND ELECTRICAL CODES SHOULD BE HIRED.**

**PLEASE READ THESE INSTRUCTIONS THOROUGHLY AND COMPLETELY PRIOR TO INSTALLATION & USE. FAILURE TO DO SO COULD CAUSE PROPERTY DAMAGE, SERIOUS INJURY, OR DEATH.**

**This manual should be shown to all members of the household who plan to use this unit, and be retained for future reference.**



Tested and certified by the Water Quality Association against NSF/ANSI 372 for lead free compliance.



## ABOUT YOUR AUTOBOOSTER™

Congratulations on the purchase of your Eemax AutoBooster™! You have purchased an innovative product from the minds of the proven experts at Eemax.

The AutoBooster™ increases the deliverable hot water capacity of any tank water heater.

TECHNICAL SPECIFICATIONS	
Voltage	240 VAC
Max Amperage	30 Amps
Max Power Rating	7.2 kW
Max Tank Power Rating	5.5 kW
Pre-Set Outlet Temperature	120°F
Activation Temp Range	80-130°F
Outlet Temperature Range	80-140°F
Activation Flow Rate	0.3 GPM

To get the best performance and energy savings from your AutoBooster™, it is important that the device is installed in accordance with our instructions and the electrical and plumbing codes applicable to your area. Read this manual thoroughly for important operating instructions and tips.

If you have questions at any time, please contact Eemax directly at:

**Eemax Inc.**

**400 Captain Neville Drive, Waterbury, CT 06705**

**Toll Free: 1-800-543-6163, or 203-267-7890 Fax: 203-267-7975**

**info@eemaxinc.com**

## CONTENTS

1 - BEFORE INSTALLATION.....	2
2 - SELECTING A LOCATION TO INSTALL .....	2
3 - SETTING UP TO INSTALL .....	3
4 - PLUMBING INSTALLATION .....	7
5 - ELECTRICAL INSTALLATION.....	8
6 - GENERAL OPERATING INSTRUCTIONS .....	12
7 - MAINTENANCE.....	12
8 - TROUBLE SHOOTING GUIDE .....	13
9 - USER INTERFACE .....	14

## 1 - BEFORE INSTALLATION

**PLEASE READ THESE INSTRUCTIONS THOROUGHLY AND COMPLETELY PRIOR TO INSTALLATION & USE. FAILURE TO FOLLOW INSTRUCTIONS COULD CAUSE PROPERTY DAMAGE, SERIOUS PERSONAL INJURY, OR DEATH.**

By installing this product, you acknowledge the terms of the manufacturer's warranty. Once the heater is installed, do not return product to the place of purchase. If you have any questions regarding the warranty or product return policies, please contact Eemax at 1-800-543-6163.

Inspect all components. The contents of your box should include the following components:

- AutoBooster™ Unit
- Cable Clamp (2x)
- Wire Nuts (2x)
- Pigtail Cord (1x)

What you will need to install:

- Phillips Head Screwdriver
- Flat Head Screwdriver
- Pipe Cutter
- Adjustable Wrench
- Teflon Tape
- Tape Measure/Ruler
- Pencil (recommended for marking measurements when cutting pipe)
- Needle-Nose Pliers (not required but may be beneficial)

## 2 - SELECTING A LOCATION TO INSTALL

This product is designed to be installed indoors only, in series with a tank water heater outlet.

DO NOT install this product in a location where it may be subject to freezing temperatures. If the water inside your unit freezes, it can cause severe and permanent damage that is not covered under your warranty.

DO NOT locate the water heater in a location that is difficult to access.

**SCALD RISK:** Make sure that the water heater and hot water outlet pipe are out of the reach of children so they cannot tamper with the temperature controls or injure themselves by touching the hot water outlet pipe. The outlet water pipe can get hot enough to scald.

 A graphic warning of scalding. It features a triangle with an exclamation point and the word 'DANGER' at the top. Below, a hand is shown being scalded by water from a faucet. The word 'HOT' is written above the water, and 'BURN' is written on the hand.	<p>Hot water can be dangerous. There is a high scald potential if the thermostat is set too high.</p> <p>Water temperatures over 125°F (51°C) can cause severe burns or scalding resulting in death.</p> <p>Hot water can cause first degree burns with exposure for as little as:</p> <p>3 seconds at 140°F (60°C) 20 seconds at 130°F (54°C) 8 minutes at 120°F (48°C)</p>
--	--

This product does NOT require venting.

Avoid installing your unit in a location prone to excessive humidity, moisture, or dust, or in an area where it may be splashed with water or other liquids. Also, avoid installation under water pipes or air conditioning lines that might leak or condense moisture that could then drip onto the heater.

DO NOT install above electrical boxes or junctions.

If you plan to install your water heater on a second floor or in an attic space, make sure that you follow all code requirements for such installations as required by your local authority. You can install an active water leak detector and shutoff valve designed to turn off your water supply in the event that a leak is ever detected.

### 3 - SETTING UP TO INSTALL

#### Recommended Clearances:

- 14 inches from above the existing tank heater to the next obstruction
- 6 inches in front of and to the sides of the AutoBooster™, for service maintenance

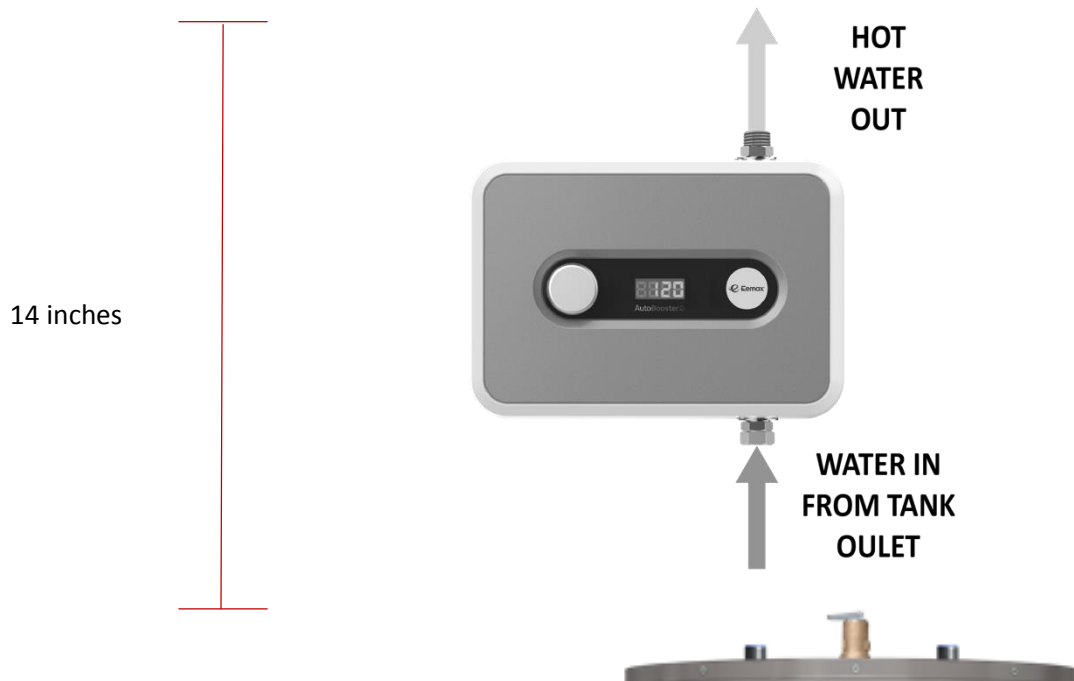

#### Pre-Mounting Steps

1. **SHUT OFF ELECTRICITY ON YOUR CIRCUIT BREAKER BEFORE PROCEEDING TO ANY FURTHER INSTALLATION STEPS.**
2. Make sure there is at least 14 inches of straight pipe clearance above the tank heater. This is the required room in order for the unit to effectively connect in series with the tank and outlet pipe.
3. Close the supply water valve to the tank heater. In most cases, this is located above the tank heater on the cold water inlet side. You must do this to drain your system.
4. Open the drain valve of the water tank to let the tank completely deplete of water. The drain valve is usually located near the bottom of the tank.
5. Drain the water from all existing hot water pipes by first opening all hot water faucets of any kind in the house. Leave the faucets open until plumbing installation is complete. If water does not stop flowing, check to make sure the inlet water to the tank heater has been completely shut off.

6. Assess your plumbing system before you cut the pipe – possible plumbing layouts on the following page. **CUTTING THE PIPE IS A CRITICAL STEP. IT IS IMPERATIVE YOU REFER TO THE GUIDE ON THE FOLLOWING PAGES FOR CLEAR INSTRUCTIONS ON HOW TO CUT THE HOT COPPER PIPE.**

**Possible Pre-Existing Plumbing Layouts**

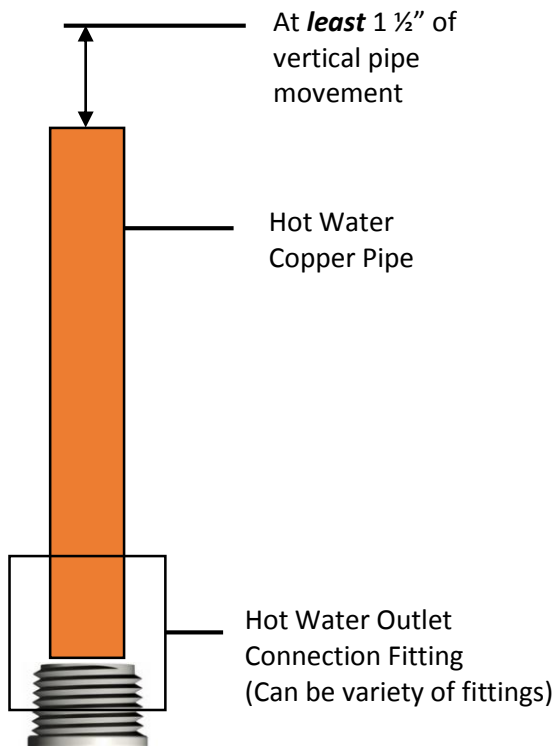

**Layout A**

- At least 14 inches of straight pipe above tank
- At least 1 1/2" of vertical pipe movement (ability to raise pipe)
- Turn to **page 5**

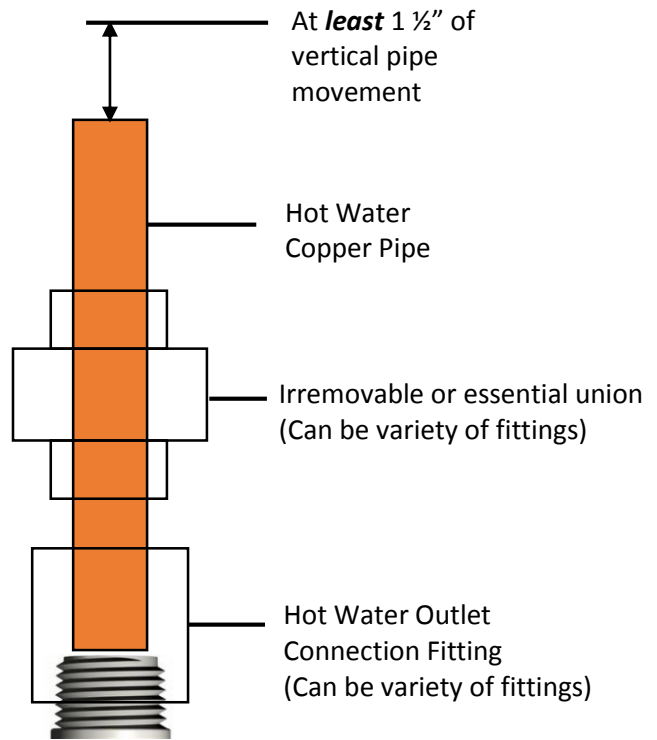

**Layout B**

- At least 20 inches of straight pipe above tank
- At least 1 1/2" of vertical pipe movement (ability to raise pipe)
- Irremovable or essential union used in plumbing
- Turn to **page 6**

**No vertical movement**  
(Pipe is completely restricted or braced)

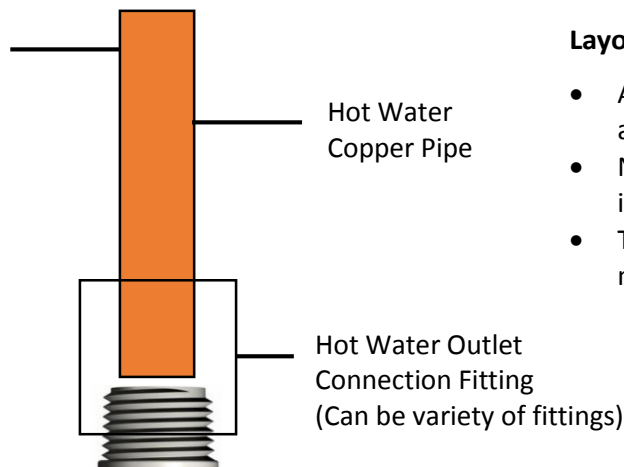

**Layout C**

- At least 14 inches of straight pipe above tank
- No vertical movement of pipe (Pipe is completely restricted or braced)
- Turn to **page 7**, hose connections may be required

### Cutting the Copper Hot Water Pipe – Layout A

Please follow all pre-installation instructions carefully. If further assistance is needed, a licensed and qualified plumber in accordance with all applicable national, state, provincial, and local plumbing codes should be hired.

1. Locate the hot water outlet connection on your pre-existing water tank. On the copper pipe, mark with a pencil 2 inches above the topmost point of the hot water outlet connection fitting.
2. Using a pipe cutter, cut the hot water copper pipe at the 2-inch mark (Cut A), as accurately as possible. **Refer to Figure A.** Once accomplished, unscrew the original connection fitting from the outlet thread of the tank.
3. On the now exposed tank outlet thread, screw on the Female NPT Adapter tightly securing this connection. **Wrap the thread 2-3 times with Teflon Tape to seal the connection and prevent leaks.**
4. From the in-place Female NPT adapter, measure upwards **EXACTLY 11 1/8 inches**. **Refer to Figure B.** Mark this on the copper pipe with a pencil. **IT IS IMPERATIVE TO BE AS ACCURATE AS POSSIBLE DURING THIS STEP. CUTTING THE PIPE TOO MUCH WILL PREVENT A SECURE CONNECTION FROM TAKING PLACE.**
5. Cut the pipe at the 11 1/8 inch mark (Cut B), taking extreme care for accuracy. If the installer is less experienced or unsure, it is advised to cut the pipe slightly below the 11 1/8 inch mark. It is safer to cut too little and correct a mistake than to cut too much.
6. Proceed to Plumbing Installation on **page 7**.

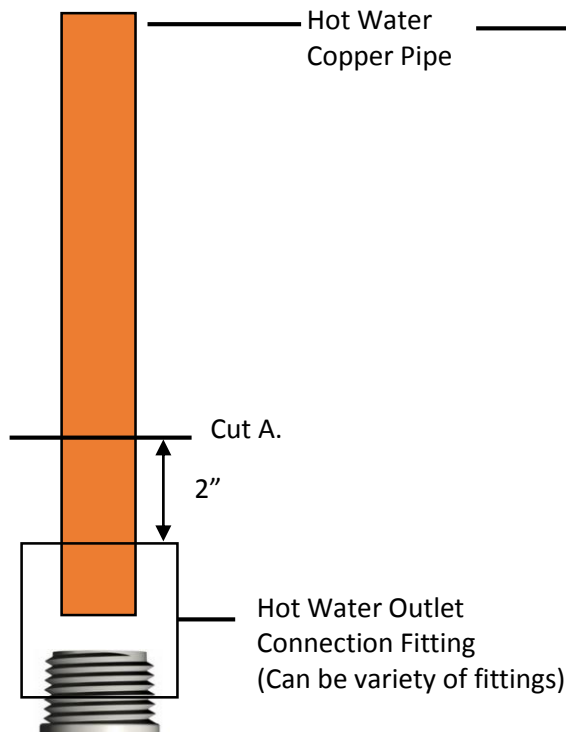

Figure A.

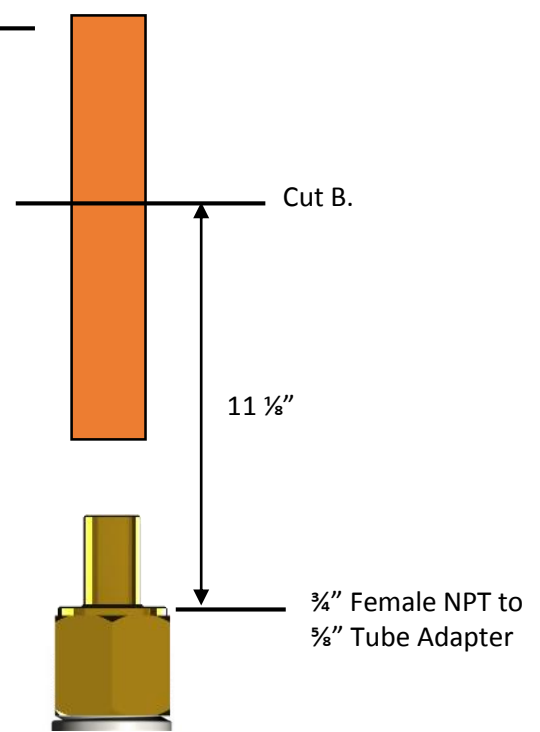

Figure B.

### Cutting the Copper Hot Water Pipe – Layout B

Please follow all pre-installation instructions carefully. If further assistance is needed, a licensed and qualified plumber in accordance with all applicable national, state, provincial, and local plumbing codes should be hired.

1. Locate the irremovable or essential union on the hot water pipe. On the copper pipe, mark with a pencil 2 inches above the topmost point of the irremovable/essential union. **Refer to Figure C.**
2. Using a pipe cutter, cut the hot water copper pipe at this 2-inch mark (**Cut C**), being as accurate as possible. Refer to Figure C. Do not remove any pipe yet, simply perform Cut C.
3. Now measure upwards **EXACTLY 12 ½ inches** from cut C. **Refer to Figure D.** Mark this on the copper pipe with a pencil. **IT IS IMPERATIVE THAT ACCURACY BE USED DURING THIS STEP. CUTTING THE PIPE TOO MUCH WILL PREVENT A SECURE CONNECTION FROM TAKING PLACE.**
4. Cut the pipe at the 12 ½ inch mark (**Cut D**), taking extreme care for accuracy. If the installer is less experienced or unsure, it is advised to cut the pipe slightly below the 12 ½ inch mark. It is safer to cut too little and correct a mistake than to cut too much.
5. Secure the fittings onto **BOTH** exposed ends of the copper pipe, making sure there are no stray or jagged pieces of copper stemming from the pipes. Make sure the fittings are pushed as far as possible onto the copper pipe, fully sealing the connection.
6. Proceed to Plumbing Installation on **page 7**.

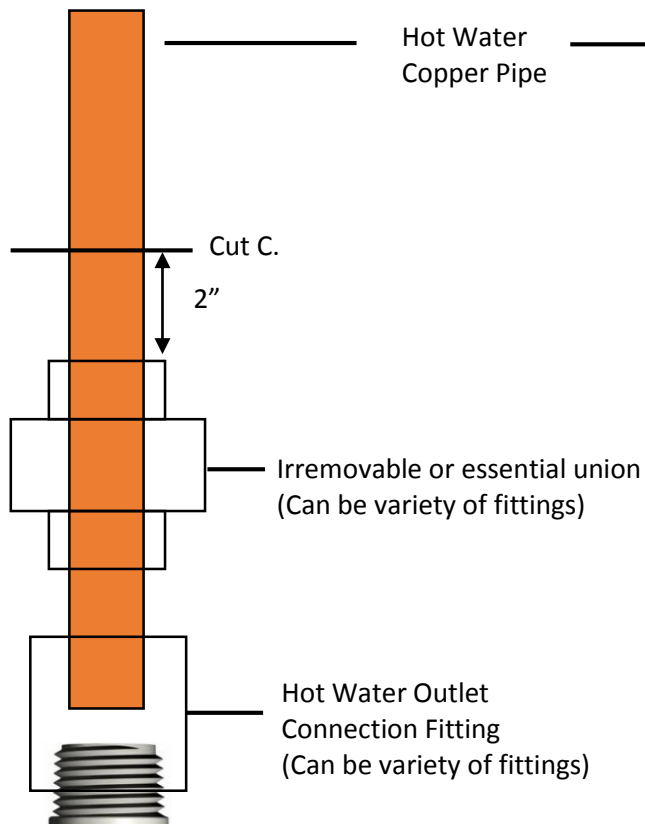

Figure C.

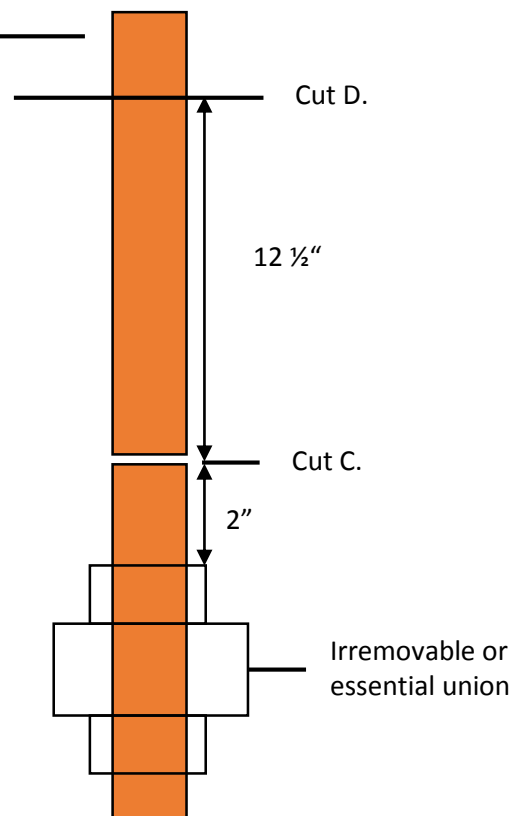

Figure D.



**Customer Service**

**Toll Free: 1-800-543-6163, or 203-267-7890**

**info@eemaxinc.com**

**4 - PLUMBING INSTALLATION**

Please follow all plumbing instructions carefully. If further assistance is needed, a licensed and qualified plumber in accordance with all applicable national, state, provincial, and local plumbing codes should be hired.

**Installation Instructions**

**STEP 1:** Using the appropriate fittings, connect the HOT WATER outlet from your water tank to the INLET thread located on the bottom side of the AutoBooster™ when facing the unit.

**STEP 2:** Connect the HOT WATER copper pipe line to OUTLET thread located on the top side of the unit.

**STEP 3:**

- Close the tank drain valve.
- Make sure at least one warm water faucet is open in the house.
- Re-open the water supply valve on the cold water copper pipe.
- You know the tank is full when water is running out of any open faucet in the house.

**FAILURE TO FOLLOW THESE STEPS WILL CAUSE WATER TANK DAMAGE.**

**STEP 4:** After tightening all fittings, open several hot water faucets and allow un-heated water to run through the water heater for at least 2 to 3 minutes. This process purges all the air from the water lines and MUST be performed prior to turning on the power at the unit.

**FAILURE TO FOLLOW THIS STEP CAN CAUSE PERMANENT DAMAGE TO THE HEATING ELEMENTS.**

If any maintenance is performed on the water heater or the home's plumbing system that may introduce air into the plumbing pipes, it is important to turn the power off to the water heater and purge the air out of the lines before allowing the unit to power up.

**STEP 5:** Carefully inspect all connections, unions, and the pressure relief valve (if installed) for leaks.

**STEP 6:** TURN OFF ALL FAUCETS BEFORE PROCEEDING TO ELECTRICAL INSTALLATION.

**IMPORTANT NOTES:**

1. This unit is equipped with both computer-controlled and electro-mechanical auto resetting thermostat switches for high-limited temperature protection. Since this product does not use a storage tank, the use of a temperature pressure relief valve (T&P) is not required for most installations. UL Standard 499 does NOT require that a pressure relief valve be used. However, a T&P valve may be required to meet installation codes in your area. If one is required, install the pressure relief valve in accordance with local codes and ensure that it operates correctly and that air is purged from the valve prior to installing the water heater. When connecting to Flex or High Temperature CPVC pipe, we recommend that a T&P valve be used for added safety.

**Please note: Installations in the Commonwealth of Massachusetts and State of Kentucky require a pressure relief valve. Please check your local installation codes for any special requirements.**

2. The maximum operating water pressure is 150 PSI. If the water pressure is higher, a pressure reducing valve must be installed on the main incoming water supply line prior to installing the unit.
3. When connecting the inlet water pipe to the unit, make sure to use a wrench to hold the unit's connection, and another wrench to tighten, so the flow sensor on the unit is not loosened or damaged. Serious internal damage to the water heater can occur if the inlet or outlet connections are over tightened or if solder connections were made.
4. We recommend that a manual shut-off valve (ball valve) be installed on the inlet and outlet of the water heater so there is a convenient shut-off point available in the event that future maintenance or servicing is required. Before connecting pipes to the water heater, it is extremely important to flush the lines to eliminate all plumbing paste or residue in the lines caused by any brazing or soldering.

We recommend that all the water pipes or hoses within 3 feet of the inlet and outlet connections be rated for high temperature applications with a 150°F minimum.

## 5 - ELECTRICAL INSTALLATION

If further assistance is needed, a licensed and qualified electrician in accordance with all applicable national, state, provincial, and local electrical codes should be hired. As with all electrical appliances, under no circumstances should you attempt to install, repair or disassemble this water heater without first shutting off all power to the unit directly at the fuse or breaker box. **Make sure to shut off all breakers. SERIOUS BODILY INJURY OR DEATH CAN OCCUR IF YOU IGNORE THIS WARNING.**

All wiring (wire gauge) and circuit protection (breakers) must comply with the U.S. National Electrical Code (NEC) in the U.S.A., or the Canadian Electrical Code (CEC) in Canada. Failure to do so could result in property damage and/or personal injury, and void your warranty.

Before installing this product, ensure that the home has sufficient electrical power available to handle the maximum amperage load of the applicable model. **TURN OFF THE ELECTRICAL POWER BEFORE PROCEEDING.**

### Installation Instructions

**STEP 1: Making sure all electrical power is shut off**, remove the **red, black** (possibly **white** in some applications), and **ground** wires from the existing tank heater coming from the circuit breaker. These wires will now go into the AutoBooster™ through the hole in the unit's back plate (see Electrical Wiring Diagram on page 9 and Connection Reference 1 on page 10.)

**STEP 2:** Using the existing wires removed from the tank in step 1, run **Line 1 (red wire)**, **Line 2 (black wire** - possibly **white** in some applications), and **ground (green wire)** from the home's main breaker panel to the AutoBooster™ water heater, through the back plate hole. See Connection Reference 1 on page 10.

**Note:** If you are installing a new circuit, select a suitable wire gauge that meets all applicable electrical codes for the size of the breakers used.

**Note:** A separate **ground** conductor for each incoming circuit is required.

**STEP 3:** Connect the supplied pigtail cord to the AutoBooster™. See Connection Reference 2 on page 11.

**STEP 4:** Now connect the wires included with the AutoBooster™ (pigtail cord stemming from the unit) to the existing tank heater. The **red, black**, and **green/yellow (ground)** wires should all have secure connections.

**MAKE SURE THESE CONNECTIONS ARE IN AN ENCLOSED AREA. EXPOSED CONNECTIONS CAN LEAD TO SERIOUS INJURY OR DEATH.**

**STEP 5:** DOUBLE CHECK the electrical connections to make sure they are correct and that all wire connections are tight and secure. Also confirm that the correct breaker size and wire gauge has been used and confirm that the unit has been connected to a ground in accordance with applicable codes.

**STEP 6:** Confirm that all the air has been purged from the water lines prior to turning on power to the unit. Refer to STEP 4 in the plumbing installation section.

**CAUTION:** Ensure that you have made the correct connections. You must follow the wiring connection as shown to ensure the proper operation of the unit. If you mix up one set of wires with another, the unit will not operate correctly even though it turns on and otherwise appears to function properly.

**Electrical Wiring Diagram**

Normal Tank Configuration:

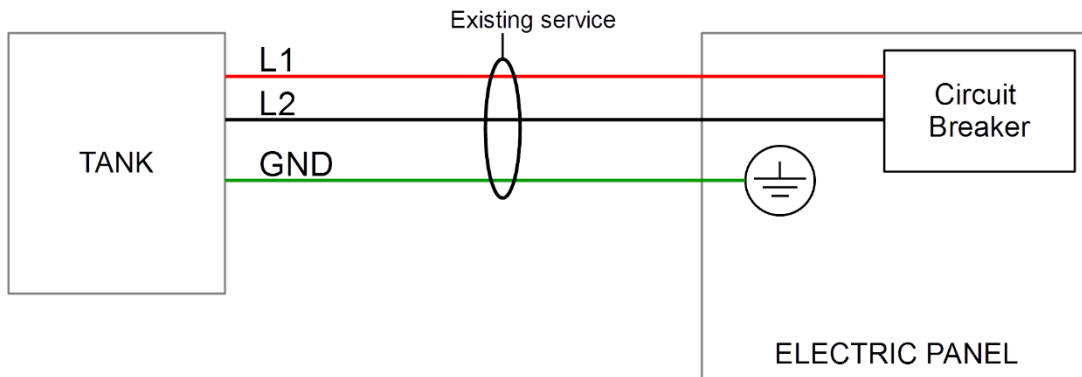

AutoBooster™ and Electric Tank Configuration:

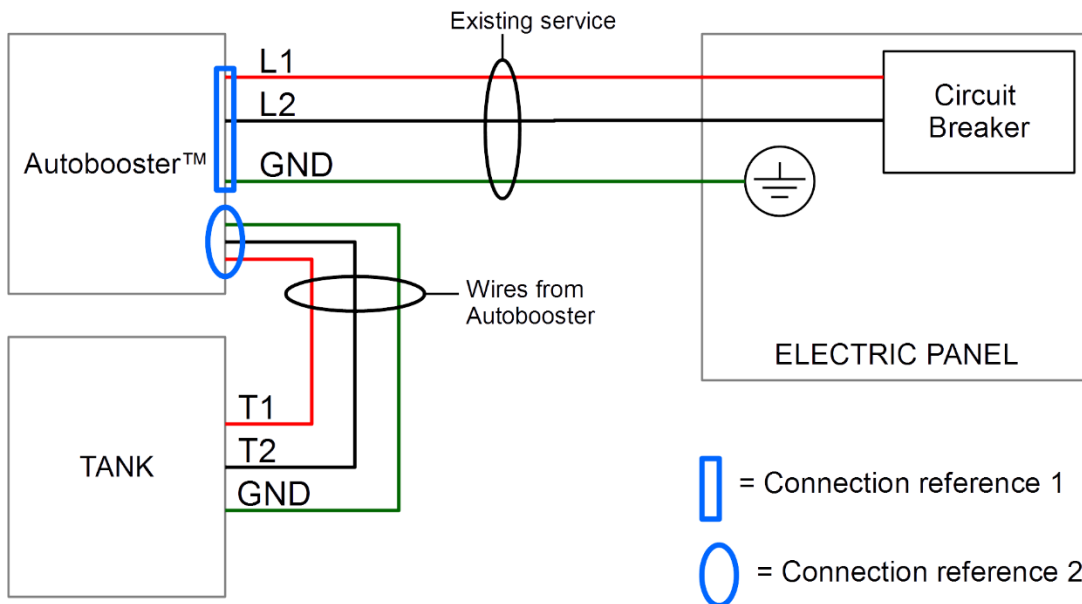

Connection Reference 1, shown on page 10.

Connection Reference 2, shown on page 11.

### Connection Reference 1

Connecting Lines 1 & 2 from the circuit breaker (existing service) to the AutoBooster™:

1. Remove the control knob from the unit, then remove the cover of the unit. Two screws must be removed in order to do this.
2. For this step, if the leads from the breaker are wrapped in a common household cable jacket, make sure the ends of the leads are exposed from the external jacket at least 10 inches. Strip back  $\frac{3}{8}$ " to bare copper on L1 and L2.



Cable Clamp

- **L1**, **L2** and **ground** (from the circuit breaker) will be connected to the AutoBooster™ inner terminal block. Make sure to thread these lines into the heater from the backside via the back plate hole, using the supplied cord grommet.
- Connect **Line 1 (red)** to the "**L1**" labelled wire terminal, and **Line 2 (black)** to the "**L2**" labelled wire terminal, using a flathead screwdriver to secure the terminal.
- Using a supplied wire nut, connect the circuit breaker **ground** wire to the **green/yellow ground** wire stem already inside the unit, which will be exposed. **Twist wires together, then twist the wire nut with both wires inside to secure the connection.**



Wire Nut

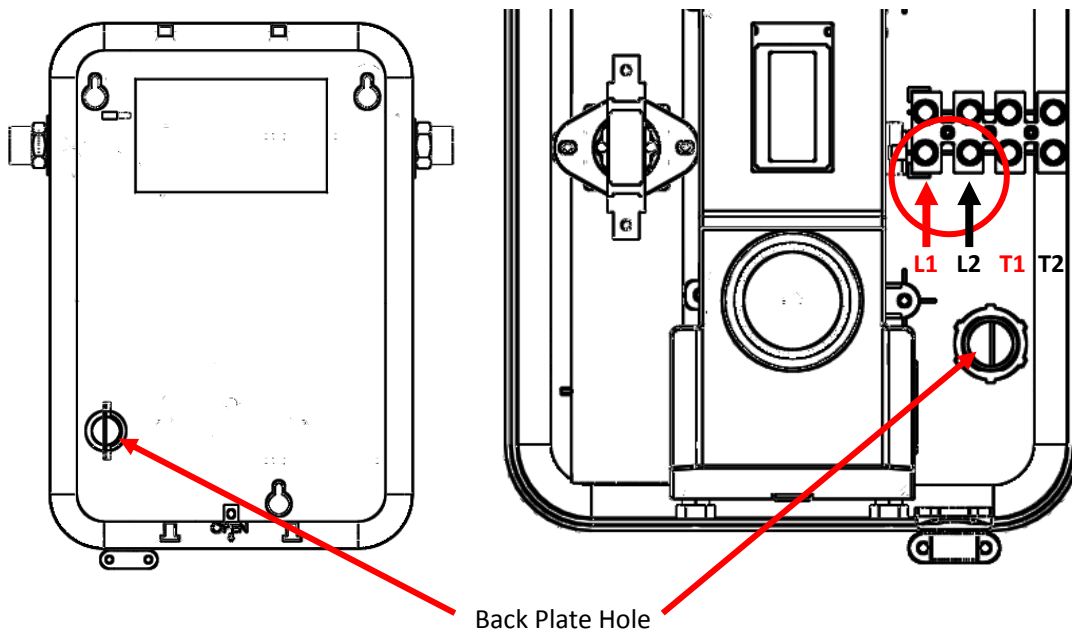

Back Plate Hole

(Installer must secure cable clamp here)

3. Tighten the connections on the terminal block with a flathead screwdriver. **MAKE SURE WIRES ARE INSERTED ALL THE WAY IN THE TERMINAL, AND THAT THE SCREWS SECURING THE CONNECTION ARE TIGHT AND SECURE. FAILURE TO DO THIS WILL CAUSE HEATER MALFUNCTION.** Wire insulation should not be inserted into the terminal block as this will inhibit a good electrical connection.
4. Proceed to Connection Reference 2 on following page.

## Connection Reference 2

Connecting the pigtail cord from AutoBooster™ to the tank heater:

1. The pigtail cord should be partially attached to the unit through the ground connection. With the cover off, you should see an exposed red wire and black wire coming from the pigtail, on the end that's inside the unit. Connect the **red** wire to the "T1" labeled wire terminal, and the **black** wire to the "T2" labeled terminal.

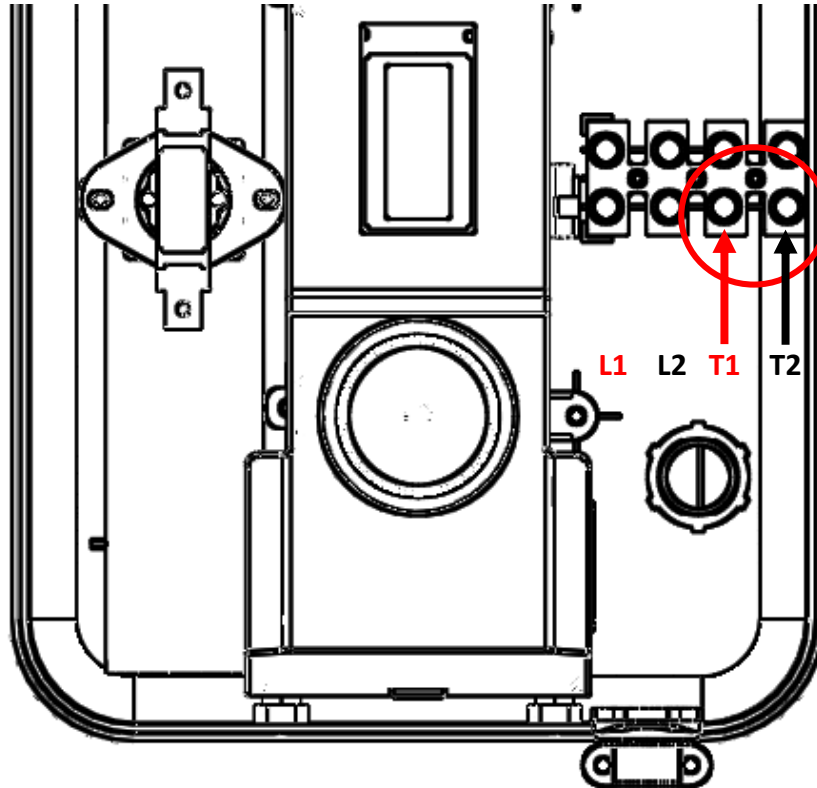

2. Tighten the connections on the terminal block with a flathead screwdriver. **MAKE SURE WIRES ARE INSERTED ALL THE WAY IN THE TERMINAL, AND THAT THE SCREWS SECURING THE CONNECTION ARE TIGHT AND SECURE. FAILURE TO DO THIS WILL CAUSE HEATER MALFUNCTION.** Wire insulation should not be inserted into the terminal block as this will inhibit a good electrical connection.
3. Take the **green/yellow** wire from the end of the pigtail, outside of the AutoBooster™, and connect it to the existing ground connection on the tank heater's terminal. If additional help is required, reference your tank heaters manual and/or contact our customer service and technical support team.
4. Replace the unit cover, control knob, and screws.

## 6 - GENERAL OPERATING INSTRUCTIONS

Operating your new unit is very similar to using any traditional water heating system. However, it is very important that you carefully read all of the set-up procedures and operating instructions and tips to ensure the maximum performance and energy savings from your new water heater. We recommend that all members of the household read these General Operating Instructions.

**How your new unit works:** The AutoBooster™ combines with the traditional hot water tank to provide an extremely effective and efficient way of heating your water. The unit reads the temperature coming out of the tank, and will turn on if the water drops below a set temperature, which you can set. The booster will keep the water at the desired temperature, another limit which you set.

## 7 - MAINTENANCE

To ensure maximum performance of your unit and to reduce the risk of a water leak, we recommend the following maintenance:

You should inspect the connections on the inlet and outlet of the unit at least on an annual basis for any signs of damage or failure. Any signs of damage, cracks, leakage or weakness should be addressed. Take care not to over-tighten the connections. Serious internal damage to your water heater can occur if you over-tighten the water heater connections at the unit.

### IMPORTANT NOTES:

As with all electrical appliances, under no circumstances should you attempt to install, repair or disassemble this water heater without first shutting off all power to the unit directly at the fuse or breaker box. **SERIOUS BODILY INJURY OR DEATH COULD OCCUR IF YOU IGNORE THIS WARNING.**

When any maintenance is performed on the unit or the home's plumbing system that may introduce air into the plumbing pipes, it is important to turn the power off to the water heater and purge the air out of the lines before allowing the unit to power up. **FAILURE TO DO SO COULD CAUSE PERMANENT DAMAGE TO THE HEATING ELEMENT AND VOID YOUR WARRANTY.**

If you have a water supply with a high level of mineralization (hard water), you should increase the frequency of your maintenance. (Remove element and inspect for scale build up, soak in vinegar or de-liming solution until scale is removed, typically within a few hours.)

## 8 - TROUBLE SHOOTING GUIDE

Are you having problems with your water heater?

Please call or email our customer service and technical support team for any help you may need.

**TOLL FREE 1-800-543-6163**

**info@eemaxinc.com**

The following table represents some of the most common technical support questions we receive. Before calling us, please read thoroughly to see if your question or problem is addressed.

PROBLEM	POSSIBLE CAUSE	SOLUTION
Unit is not heating at all (water is flowing but the unit is not heating at all — the outgoing water temperature is the same as my cold water supply) and/or the digital display does NOT light up.	No power or incorrect wiring.	Make sure the breakers at main electrical panel are ON. You may have a faulty breaker or unit may be wired incorrect. Refer to page 9 for proper wiring layout.
	Internal part failure.	Please call us for technical assistance.
Unit is not heating at all (water is flowing but the unit is not heating at all - the outgoing water temperature is the same as my cold water supply) The digital display DOES light up.	Internal part failure.	Please call us for technical assistance.
	Flow rate is too low / water pressure is too low	Your water heater has an activation flow rate of approximately 0.3 GPM. If your water flow rate is less than this level, your unit will not activate. Increase the flow rate.
	Activation temperature too low	The water heater will turn on when the temperature of the water at the inlet of the AutoBooster™ falls below the activation temperature (when the tank is not providing hot water). Increase activation temperature.
Unit is heating but the water temperature is not hot enough.	User temperature setting too low.	Turn up the temperature setting on the unit.
	Voltage less than 240 volts.	The heating elements on your unit are designed for 240 volts. When use with a lower voltage, they produce less heating power.
	Mixing too much cold water	You may have an anti-scald feature on your faucet that is mixing cold water. These types of faucets can usually be adjusted to reduce the amount of cold water mixed. Also, your tank may be completely out of hot water and is mixing cold water. Give the tank time to recover or reduce the amount of water you are using.
The water temperature at my faucet is less than the temperature setting of my water heater.	Voltage less than 240 volts.	The computer chips in your unit are programmed with the expectation that your incoming line voltage is 240 volts. If you have less than 240 volts, it may affect the reading on your unit's digital display and cause it to read slightly higher than the actual output temperature. To compensate for this, increase the setting on your unit if you need / want hotter water.
	Anti-Scald pressure/balancing valve or tempering valve.	Your faucet may have an anti-scald feature or a tempering valve that automatically mixes cold water even when you turn your control lever or handle to full hot. These devices are usually adjustable so you can turn off the cold mix completely. You can compensate for this by increasing the setting on your unit if you need/want hotter water.
	Thermal loss due to long pipe run	As the hot water from the unit runs through the hot water delivery system to your faucet, some heat will be lost especially if it has long distance to travel or the pipes are cold. This is normal. You can compensate for this by increasing the setting on your unit if you need/want hotter water.
Pre-existing water tank is not heating.	Incorrect wiring.	The unit may be wired incorrectly. Refer to page 9 for proper wiring layout.
	Relay switch is defective.	Please call us for technical assistance.
Unit displays 999 as inlet and/or outlet temperature	Thermistor on corresponding channel is defective	Please call us for technical assistance





**AutoBooster™ Features**

**List of Menu Options Provided by the Software (Clarified Below and on Following Page):**

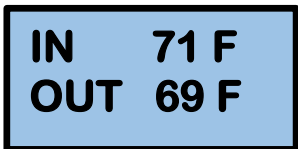

- Inlet/Outlet Temperature Reading
- Active Unit in Operation
- Activation Temperature
- Max Temperature
- Software Version
- Eco Mode
- Vacation Mode
- Freeze Protect

**Primary Menu Cycle Screens**

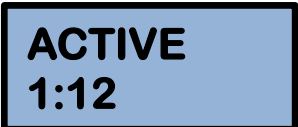
Turn the control knob in either direction to cycle through menu options.

<p><b>Inlet/Outlet Temperature Reading</b> The temperature of the water going in and out of the AutoBooster™ can be observed from this display.</p>	
<p><b>Active Unit in Operation</b> This screen will tell the user which heating unit is operating at that given point in time. It will either be the pre-existing water tank (“TANK”) or the AutoBooster™ (“UNIT”).</p>	
<p><b>Flow</b> The flow screen will tell the user the amount of water that is flowing through the unit in gallons per minute.</p>	
<p><b>Load Factor</b> Here you can see how hard your AutoBooster™ is working.</p>	
<p><b>Clock</b> Set the time here (HOURS:MINUTES:SECONDS). Press the knob to cycle through hours, minutes, seconds and turn the knob to adjust the number.</p>	
<p><b>Active Time</b> The active time screen will display how long the unit has been actively heating water. The time is displayed in HOURS:MINUTES</p>	







<p><b>Total Time</b></p> <p>This screen tells the user the total amount of time the unit has been on in its lifespan</p>	
<p><b>Setup</b></p> <p>If the knob is pressed once on this screen, the user will be taken to all the booster heating set up interface. <b>ALL OF THE FOLLOWING SET UP CYCLE SCREENS WILL ORIGINATE FROM PRESSING THE KNOB ONCE ON THIS DISPLAY.</b></p>	



**AutoBooster™ Built-In Freeze Protect Feature (Select Models Only)**

While the AutoBooster™ is off, if the temperature read at the inlet of the AutoBooster™ unit drops below 60°F, the tank will automatically power on to prevent the nearby pipes from freezing and potentially bursting. Once the temperature at the inlet of the AutoBooster™ exceeds 60°F again, the tank will power back off.

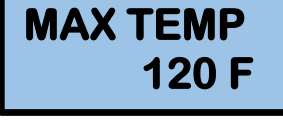
**AutoBooster™ Set Up Menu Cycle Screens**

**Turn the control knob in either direction to cycle through menu options.**

<p><b>Activation Temperature</b></p> <p>The first heater setting is the activation temperature. If the unit reads an inlet temperature that below the activation temperature, the unit will turn on. For instance, if the activation temperature is 115°, and water coming into the unit is below 115°, the unit will turn on. To change this setting, press the knob once, and a “*” will appear on screen. Turn the knob to adjust temp, and then press the knob again to save the setting.</p>	 
<p><b>Max Temperature</b></p> <p>Here you can set the maximum temperature you want the AutoBooster™ to heat the water up to. To change the set temperature, press the knob once, and a “*” will appear on screen. Turn the knob to adjust temperature, and then press the knob again to lock in the setting.</p>	 
<p><b>Vacation Mode (Select Models Only)</b></p> <p>Vacation mode will shut down the heater while you go away on vacation. To change this setting, press the knob once, and a “*” will appear on screen. Turn the knob to adjust ON/OFF, and then press the knob again to save the setting. Note, freeze protect feature will override vacation mode.</p>	

<p><b>Eco Mode</b></p> <p>Eco mode will turn the tank off and on at specific times of the day, set by the user, in order to conserve energy.</p>	 A rectangular button with a black border and a light blue background. The text "ECO MODE" is on the top line and "OFF" is on the bottom line, both in bold black uppercase letters.
<p><b>Software Version</b></p> <p>Here you can view the heater software version (useful for troubleshooting).</p>	 A rectangular button with a black border and a light blue background. The text "VERSION" is on the top line and "210" is on the bottom line, both in bold black uppercase letters.
<p><b>Exit</b></p> <p>If knob is pressed once on this screen, the user will be taken back to the primary menu screen cycle.</p>	 A rectangular button with a black border and a light blue background. The text "SETUP" is on the top line and "EXIT" is on the bottom line, both in bold black uppercase letters.



**Eemax<sup>TM</sup>**

**Eemax Inc.**

**400 Captain Neville Drive, Waterbury, CT 06705**

**Toll Free: 1-800-543-6163, or 203-267-7890 Fax: 203-267-7975**

**[info@eemaxinc.com](mailto:info@eemaxinc.com)**