



The new degree of comfort.®



Residential Electric  
Professional *Prestige* ProTerra  
Hybrid Electric Heat Pump Water Heaters

## Professional *Prestige*® ProTerra® Hybrid Electric Heat Pump is the most efficient water heater available

### Efficiency

- Up to 4.07 UEF reduces operating cost
- ENERGY STAR® certified
- Title 24 Compliant (JA13 Ready)

### Performance

- Delivers hot water faster than most standard electric water heaters – 60-87 gallons first-hour delivery, depending on model
- Ambient operating range: 37-145° F is widest in class, offering more heat pump operation annually; designed to meet Northern Climate Spec (Tier 4)
- Quiet Operation

### Easy Installation

- Universal top and side water connections
- Quick access to electrical junction box
- Duct ready design
- Easily replaces a standard electric water heater

### Integration

- Electronic control for easy temperature adjustment and mode management
- Audible alarm for service alerts
- Built-in Wi-Fi powered by EcoNet®\* and free mobile app gives users control over water heater, allowing for customizable temperature, vacation settings, energy savings and system monitoring at home or away
- Demand Response Ready with built-in EcoPort™ (CTA-2045 Port)
- **Easily add leak detection and prevention with the leak sensor and shutoff valve kit (part# SP21265A sold separately)**

### Operation Modes

- Energy Saver
- Heat Pump
- High Demand
- Electric
- Vacation/Away: 2-28 days (or placed on hold indefinitely)

### Plus...

- Premium grade anode rod extends the life of the tank
- Dip tube diffuser reduces sediment improving efficiency and tank life
- 3/4" NPT water inlet and outlet; 3/4" condensate drain connections
- Incoloy stainless steel resistor elements
- Dry-fire protection
- Easy access, top mounted washable air filter
- 2" Non-CFC foam insulation
- Enhanced flow brass drain valve
- Temperature and pressure relief valve installed
- Design certified to NSF/ANSI 372 (Lead Content)

### Warranty

- 10-Year limited tank and parts warranty  
See Residential Warranty Certificate for complete information

Units meet or exceed ANSI requirements and have been tested according to D.O.E. procedures. Units meet or exceed the energy efficiency requirements of NAECA, ASHRAE standard 90, ICC Code and all state energy efficiency performance criteria.



## Professional *Prestige* ProTerra Hybrid Electric Heat Pump

40, 50, 65 and 80-Gallon Capacities  
208-240 Volt / 1 PH  
30 and 15 Amp Electric



LEED Points = 3

\*Wi-Fi broadband internet connection required.

See specifications chart on next page.



INTEGRATED HOME COMFORT

# Professional *Prestige*® ProTerra Hybrid Electric Heat Pump Specifications

DESCRIPTION					ENERGY INFO	FEATURES							SHIPPING WEIGHTS	
NOMINAL GALLON CAPACITY	RATED GALLON CAPACITY	MODEL NUMBER	MODEL VARIANT	ELECTRIC BREAKER SIZE	UNIFORM ENERGY FACTOR (UEF)	COMPRESSOR BTU/H	UEF FIRST HR. RATING G.P.H.	RECOVERY IN G.P.H 90° F RISE	ELEMENT WATTAGE	TOTAL UNIT WATTAGE	MAX AMPS	UNIT WT. (LBS)	APPROX. SHIP WT. (LBS.)	
<b>ProTerra 30 Amp</b>														
40	36	CPROPH40 T2 RH400-30	702273	30	3.83	4,200	60	27	4,500	5,000	21	166	184	
50	45	CPROPH50 T2 RH400-30	702274	30	3.88	4,200	67	27	4,500	5,000	21	185	203	
65	59	CPROPH65 T2 RH400-30	702275	30	4.05	4,200	76.6	27	4,500	5,000	21	245	289	
80	72	CPROPH80 T2 RH400-30	702277	30	4.07	4,200	87	27	4,500	5,000	21	261	306	
<b>ProTerra 15 Amp</b>														
40	36	CPROPH40 T2 RH400-15	702313	15	3.45	4,200	46	16	2,250	2,750	12	166	184	
50	45	CPROPH50 T2 RH400-15	702316	15	3.75	4,200	52	16	2,250	2,750	12	185	203	
65	59	CPROPH65 T2 RH400-15	702312	15	3.55	4,200	54	16	2,250	2,750	12	245	289	
80	72	CPROPH80 T2 RH400-15	702314	15	3.70	4,200	67	16	2,250	2,750	12	261	306	

Uniform Energy Factor and rated gallon capacity based on Department of Energy (DOE) requirements. All units have integrated Wi-Fi control board.

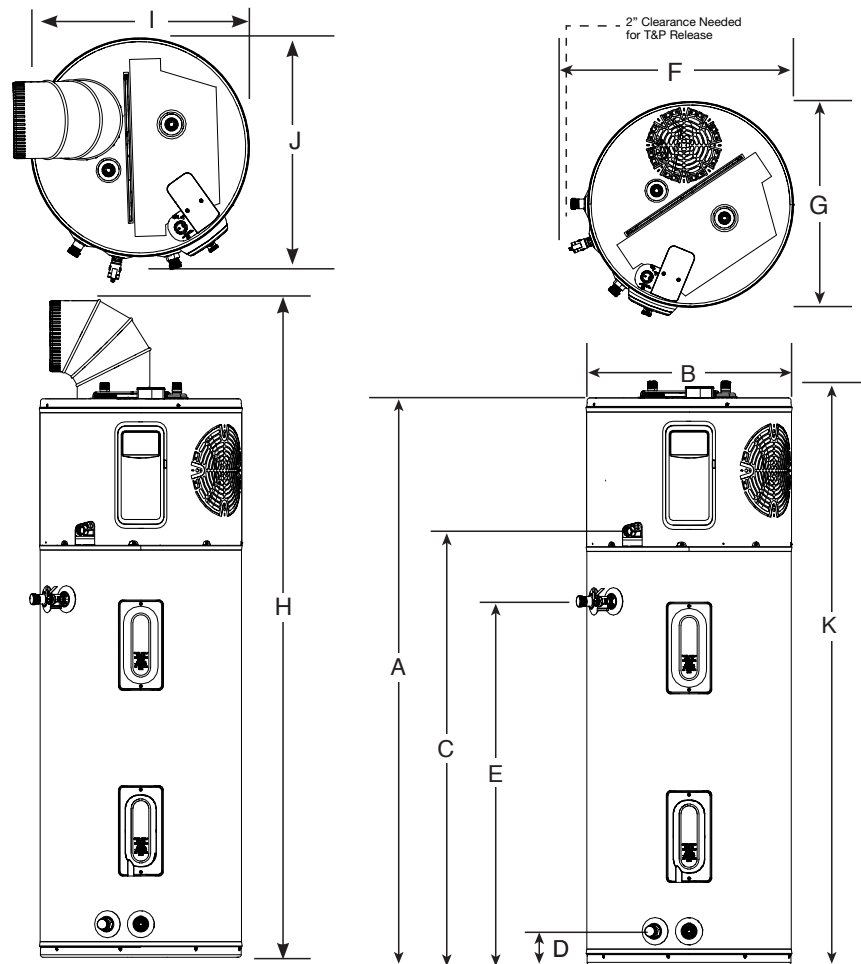

DESCRIPTION		DIMENSIONS (SHOWN IN INCHES)										
NOMINAL GALLON CAPACITY	MODEL NUMBER	A	B	C	D	E	F	G	H	I	J	K
40	CPROPH40	62-5/16	20-1/4	47	3-5/8	39-5/8	25-3/8	20-1/2	78-7/8	20-1/4	21-3/4	64-15/16
50	CPROPH50	61-3/4	22-1/4	47	3-5/8	39-5/8	27-3/8	22-1/2	78-5/8	22-1/4	21-3/4	64-3/8
65	CPROPH65	64-3/16	24-1/4	49	3-7/8	42-3/8	29-1/2	24-5/8	81-1/8	24-1/4	25-13/16	66-13/16
80	CPROPH80	74-3/16	24-1/4	59	3-7/8	42-3/8	29-1/2	24-5/8	91	24-1/4	25-11/16	76-13/16

# Hybrid Electric Heat Pump Water Heater Installation Guidelines to Provide Optimal Efficiency

## Heater: Not Ducted

Room size: Larger than 700 ft<sup>3</sup> (e.g. 7' x 10' x 10').  
 Requirements: No additional ventilation needed.

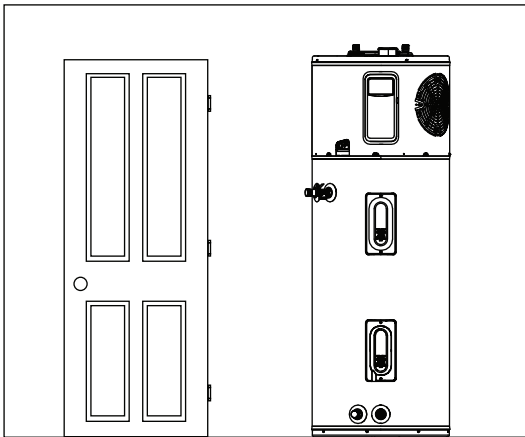

## Heater: Not Ducted

Room size: Smaller than 700 ft<sup>3</sup> (e.g. 7' x 10' x 10').  
 Requirements: Full louvered door OR two louvers top and bottom. See below.

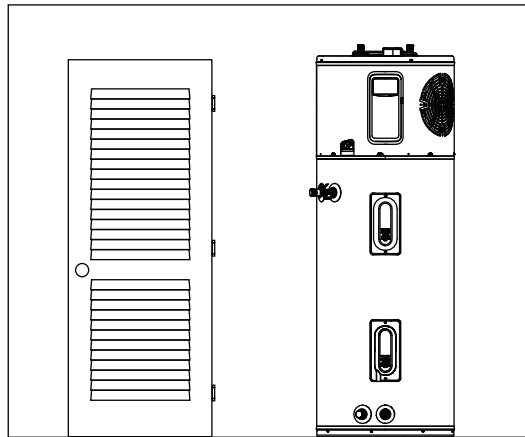

## Heater: Not ducted

Room: Small Closet

- Requirements: \*
- \* Air gap under door equal to 18 in<sup>2</sup> (0.75" clearance).
  - \* Louver must be located the same height on door as the air exhaust on heater.
  - \* Heater air exhaust must be positioned towards louver within one foot of door.

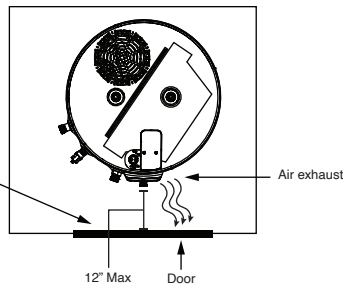
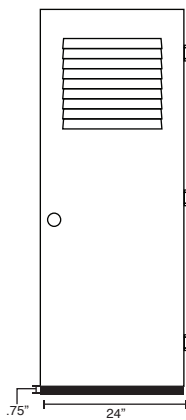

## Heater: Ducted with inlet OR outlet duct

Room size: Any size room  
 Requirements: Air gap under door equal to 18 in<sup>2</sup> (0.75" clearance)

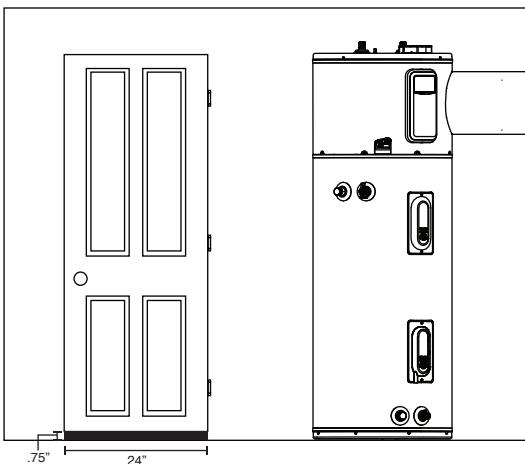

## Heater: Ducted with inlet AND outlet duct

Room size: Any size room  
 Requirements: No additional ventilation needed.

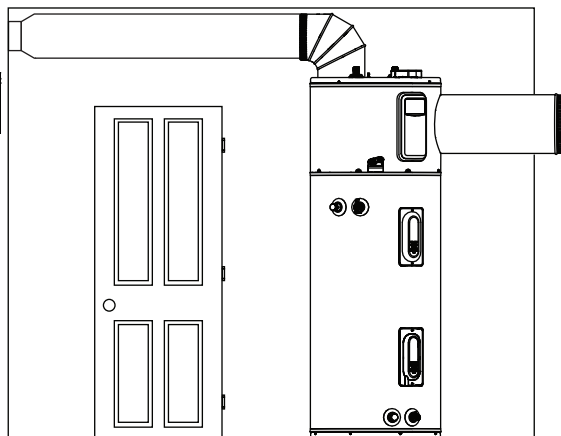

**NOTE:** Heat pump water heater will operate in rooms less than 700 ft<sup>3</sup> down to 450 ft<sup>3</sup> but at reduced energy efficiency and reduced performance output. Reduced energy efficiency and performance has not been evaluated by Rheem Manufacturing and not recommended for optimal performance of the unit. When unit is operated in a small enclosure, a door or wall with a minimum of 2.3 sq ft of louvers is recommended to provide proper air changes for unit function.



The new degree of comfort®



## Hybrid Electric Heat Pump Accessories List

PART NUMBER	DESCRIPTION	USE FOR
AP19134	Leak Sensor	Automatic detection of internal and external leaks
AS50618A	Shutoff Valve	Automatic shutoff of water supply to unit
SP20882	Earthquake Isolation Kit	Installations in seismic regions
SP20883	Vibration Isolation Kit	Installation on non-concrete floors
SP20884	8" Diameter UL Certified Termination Kit	Termination to the outside or to the attic with 8" diameter
SP20885	7" Diameter UL Certified Termination Kit	Termination to the outside or to the attic with 7" diameter
SP20886	6" Diameter UL Certified Termination Kit	Termination to the outside or to the attic with 6" diameter
SP20887	5" Diameter UL Certified Termination Kit	Termination to the outside or to the attic with 5" diameter
SP20888	8" Collar for Flex Venting	Exhaust only to the outside ducting configuration (no inlet duct)
SP20889	25' Flexible 8" Diameter Duct Kit	For up to 25' of ducting
SP20890	8" Rigid Elbow Duct Kit	Installation in tight places where space needs to be minimized
<b>UPGRADE KIT</b>		
SP21265A	Kit - Automatic Shutoff Valve Assembly	Add leak detector, shutoff valve and S.O.V. extension harness for top connection setup

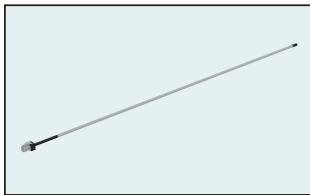

Leak Sensor



Shutoff Valve

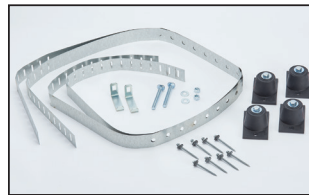

Earthquake Isolation Kit

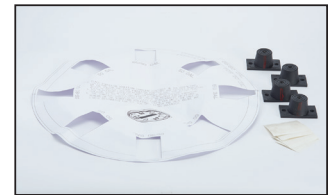

Vibration Isolation Kit

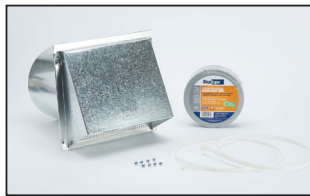

8" Diameter UL Certified Termination Kit



7" Diameter UL Certified Termination Kit



6" Diameter UL Certified Termination Kit



5" Diameter UL Certified Termination Kit



8" Collar for Flex Venting



25' Flexible 8" Diameter Duct Kit



8" Rigid Elbow Duct Kit

**UPGRADE KIT (for ProTerra models without LeakGuard only) – Add leak detector and shutoff valve to protect from water damage**

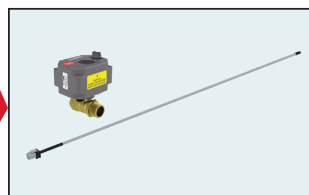

Leak Sensor & Shutoff Valve Kit

In keeping with its policy of continuous progress and product improvement, Rheem reserves the right to make changes without notice.

Rheem Canada Ltd./Ltée • 125 Edgeware Road, Unit 1  
Brampton, Ontario L6Y 0P5 • www.rheem.ca

