



MODEL: SP14**F Heat Pumps

FORM NO. PSC-810 REV. 3



Sure Comfort® SP14**F Heat Pumps

- **Efficiencies: 14.5 SEER/12.0 EER**
- **Nominal Sizes 1½ to 5 Ton [5.28 to 17.6 kW]**
- **Cooling Capacities 17.3 to 60.5 kBTU [5.7 to 17.7 kW]**



"Proper sizing and installation of equipment is critical to achieve optimal performance. Split system air conditioners and heat pumps must be matched with appropriate coil components to meet Energy Star. Ask your Contractor for details or visit www.energystar.gov."

- The SP14**F series is designed to achieve 14 SEER with Coil only (for the dual fuel market) and PSC Air Handlers match ups.
- New composite base pan – dampens sound, secures wire grille, eliminates corrosion and reduces number of fasteners needed
- Improved tubing design – reduces vibration and stress, making unit quieter and reducing opportunity for leaks
- Optimized defrost characteristics - decrease defrosting and provide better home comfort
- Powder coat paint system – for a long lasting professional finish
- Optimized reversing valve sizing – improves shifting performance for quieter unit operation and increased life of the system
- Enhanced mufflers – help to dissipate vibration energy for quieter unit operation
- Scroll compressor – a sound abating feature added to the compressor significantly reduces noise when system transitions in and out of defrost mode
- Modern cabinet aesthetics – increased curb appeal with visually appealing design
- Wire grille – provide ultimate coil protection, enhance cabinet strength, and increased cabinet rigidity
- Optimized fan orifice – optimizes airflow and reduces unit sound
- Rust resistant screws – confirmed through 1500-hour salt spray testing
- 3"-4"-5" service valve space – provides a minimum working area of 27-square inches for easier access
- Integrated heat pump lift receptacle – allows standard CPVC stands to be inserted into the base
- 15" wide, industry leading corner service access – makes repairs easier and faster.
- External gauge port access – allows easy connection of "low-loss" gauge ports
- Single-row condenser coil – makes unit lighter and allows thorough coil cleaning to maintain "out of the box" performance
- Fewer cabinet fasteners – allow for faster access to internal components and hassle-free panel removal
- Service trays – hold fasteners or caps during service calls
- QR code – provides technical information on demand for faster service calls
- Fan motor harness with extra-long wires – allows unit top to be removed without disconnecting fan wire

Table of Contents

Standard Feature Table	3
Available SKUs	3
Features & Benefits	4-5
Model Number Identification	6
Physical Data	7
Electrical Data	7
Accessories	8
Weighted Sound Power	8
Unit Dimensions.....	9
Clearances.....	10
Wiring Diagrams	11
System Design Summary	11
Refrigerant Line Size Information	12-15
Performance Data	16
Guide Specifications	17
Limited Warranty	18

Standard Feature Table

Feature	18	24	30	36	42	48	60
R-410a Refrigerant	√	√	√	√	√	√	√
Maximum SEER	14.5	14.5	14.5	14.5	14.5	14.5	14.5
Maximum EER	12.0	12.0	12.0	12.0	12.0	12.0	12.0
Maximum HSPF	8.5	8.5	8.5	8.5	8.5	8.5	8.5
Scroll Compressor	√	√	√	√	√	√	√
Field Installed Filter Drier	√	√	√	√	√	√	√
Front Seating Service Valves	√	√	√	√	√	√	√
High Pressure Switch	√	√	√	√	√	√	√
Low Pressure Switch	√	√	√	√	√	√	√
Internal Pressure Relief Valve	√	√	√	√	√	√	√
Internal Thermal Overload	√	√	√	√	√	√	√
Long Line capability	√	√	√	√	√	√	√
Low Ambient capability with Kit	√	√	√	√	√	√	√
3-4-5 Service Valve Access	√	√	√	√	√	√	√
Composite Basepan	√	√	√	√	√	√	√
2 Screw Control Box Access	√	√	√	√	√	√	√
15" Access to Internal Components	√	√	√	√	√	√	√
Optimized Venturi Airflow	√	√	√	√	√	√	√
Single row condenser coil	√	√	√	√	√	√	√
Powder coated paint	√	√	√	√	√	√	√
Rust resistant screws	√	√	√	√	√	√	√
QR code	√	√	√	√	√	√	√
External gauge ports	√	√	√	√	√	√	√
Service trays	√	√	√	√	√	√	√

√ = Standard

Available SKUs

Available Models
SP1418GJ1NA
SP1424FJ1NA
SP1430FJ1NA
SP1436FC1NA
SP1436FJ1NA
SP1442GC1NA
SP1442GJ1NA
SP1448FC1NA
SP1448FJ1NA
SP1460FC1NA
SP1460FJ1NA

Introduction to SP14**F Heat Pump

The SP14**F is our 14 SEER heat pump and is part of the Sure Comfort heat pump product line that extends from 14 to 16 SEER. This highly featured and reliable heat pump is designed for years of reliable, efficient operation when matched with Sure Comfort indoor aluminum evaporator coils and furnaces or air handler units with aluminum evaporators.

Our unique composite base (1) reduces sound emission, eliminates rattles, reduces fasteners, eliminates corrosion and has integrated brass compressor attachment inserts (2). Furthermore it has incorporated into the design, water management features, means for hand placement (3) for unit maneuvering, screw trays (4) and inserts for lifting off unit pad. (5)

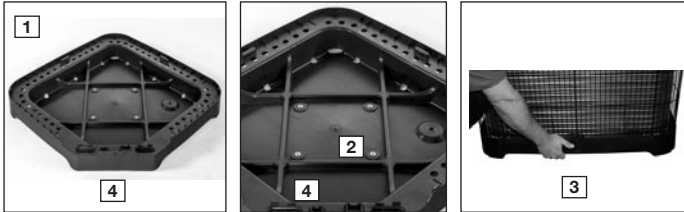

Service Valves (6) are rigidly mounted in the composite base with 3" between suction and discharge valves, 4" clearance below service valves and a minimum of 5" above the service valves, creating industry leading installation ease.

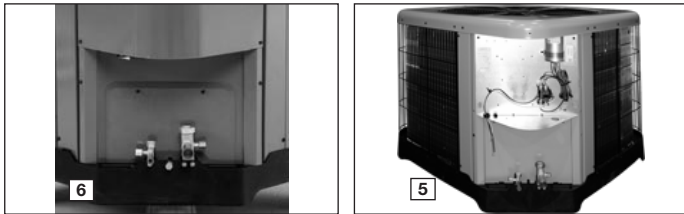

The minimum 27 square-inches around the service valves allows ample room to remove service valve schrader prior to brazing, plenty of clearance for easy brazing of the suction and discharge lines to service valve outlets, easy access and hookup of low loss refrigerant gauges (7), and access to the service valve caps for opening. For applications with long-line lengths up to 250 feet total equivalent length, up to 200 feet condenser above evaporator, or up to 80 feet evaporator above condenser, the long-line instructions in the installation manual should be followed.

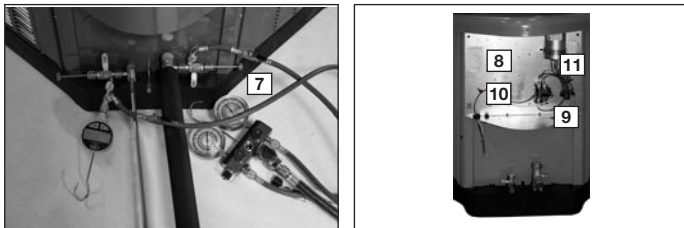

Controls are accessed from the corner of the unit by removing only three fasteners from the control access cover, revealing the industry's largest 15" wide and 14" tall control area (8). With all this room in the control area the high voltage electrical whip (9) can easily be inserted through the right size opening in the bottom of the control area. Routing it leads directly to contractor lugs for connection. The low voltage control wires (10) are easily connected to units low voltage wiring. If contactor or capacitor (11) needs to be replaced there is more than adequate space to make the repair.

If in the rare event, greater access is needed to internal components, such as the compressor, the top cover can be removed easily. Furthermore with the top cover removed the control panel can be removed (12). Extra wire length is incorporated into each outdoor fan and compressor so top cover and control panel can be positioned next to the unit. With minimal effort the plug can be removed from the compressor and the outdoor fan wires can be removed from the capacitor to allow even more uncluttered access to the interior of the unit (13). Outdoor coil heights range from as short as 22" to 32", aiding access to the compressor. Disassembly to this degree and complete reassembly only takes a first time service technician less than 10 minutes. (13)

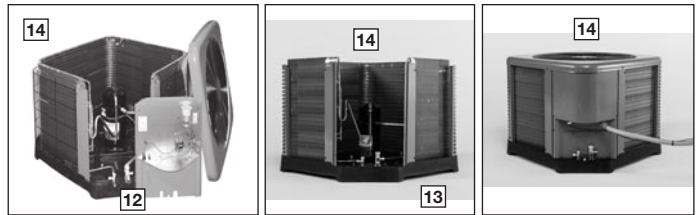

All SP14**F units utilize single row coils (14) making cleaning easy and complete, restoring the performance of the heat pump back to out of the box performance levels year after year.

The outdoor fan motor has sleeve bearings and is inherently protected. The motor is totally enclosed for maximum protection from weather, dust and corrosion. Access to the outdoor fan is made by removing four fasteners from the fan grille. The outdoor fan can be removed from the fan grille by removing 4 fasteners in the rare case outdoor fan motor fails.

Each cabinet has optimized composite (15) fan orifice assuring efficient and quiet airflow.



All cabinet painted parts have powder post paint ((16)) achieving 1000 hour salt spray rating, allowing the cabinet to retain its aesthetics throughout its life.

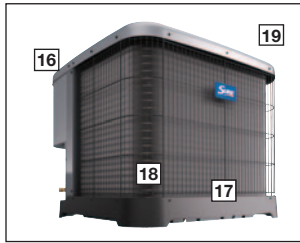

Scroll compressors with standard internal pressure relief and internal thermal overload are used on all capacities assuring longevity of high efficient and quiet operation for the life of the product.

Each unit is shipped with filter drier for field installation and will trap any moisture or dirt that could contaminate the refrigerant system.

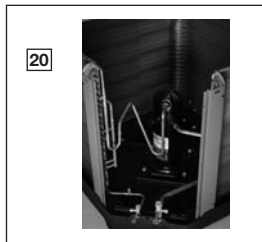

Cabinets are durable and strong due to the composite base pan ((17)), wire grille ((18)), and drawn top cover ((19)).

Each SP14**F capacity has undergone rigorous psychometric testing to assure performance ratings of capacity, SEER and EER per AHRI Standard 210/240 rating conditions. Also each unit bears the UL mark and each unit is certified to UL 1995 safety standards.



Each unit has undergone specific strain and modal testing to assure tubing ((20)) is outside the units natural frequency and that the suction and discharge lines connected to the compressor withstand any starting, steady state operation or shut down forces imposed by the compressor.

All units have been sound tested in sound chamber to AHRI 270 rating conditions, and A-weighted Sound Power Level tables produced, assuring units have acceptable noise qualities (see page 9). Each unit has been ran in cooling operation at 95°F and 82°F and sound ratings for the SP14**F range from as low as 74 dBA to 77 dBA.

All units have been ship tested to assure units meet stringent "over the road" shipping conditions.

As manufactured all units in the SP14**F family have cooling capability to 55°F. Addition of low ambient control will allow the unit to operate down to 0°F. Factory testing is performed on each unit. All component parts meet well defined specification and continually go through receiving inspections. Each component installed on a unit is scanned, assuring correct component utilization for a given unit capacity and voltage. All condenser coils are leak tested with pressurization test to 550#’s and once installed and assembled, each units’ complete refrigerant system is helium leak tested. All units are fully charged from the factory for up to 15 feet of piping. All units are factory run tested. The SP14**F has a 10-year conditional compressor and parts warranty (registration required).

Optional Accessories

(Refer to accessory chart for model #)

Compressor Crankcase Heater

Protects against refrigerant migration that can occur during low ambient operation

Compressor Sound Cover

- Reinforced vinyl compressor cover containing a 1½ inch thick batt of fiberglass insulation
- Open edges are sealed with a one-inch wide hook and loop fastening tape

Compressor Hard Start Kit

- Single-phase units are equipped with a PSC compressor motor, this type of motor normally does not need a potential relay and start capacitor
- Kit may be required to increase the compressor starting torque, in conditions such as low voltage

Low Ambient Kit

- Heat pump operate satisfactorily in the cooling mode down to 55°F outdoor air temperature without any additional controls
- This Kit can be added in the field enabling unit to operate properly down to 0° in the cooling mode
- Crankcase heater and freezestat should be installed on compressors equipped with a low ambient kit

3"/6"/12"

- Gray high density polyethylene feet are available to raise unit off of mounting surface away from moisture

Low Pressure

- Can be added in field enabling the unit to shut off compressor on loss of charge

NOTE: Unit can be purchased with high and low pressure installed at factory. (Refer to SKU list)

High Pressure

- Can be added in field enabling unit to shut off compressor if unit loses outdoor fan operation.

NOTE: Unit can be purchased with high and low pressure installed at factory. (Refer to SKU list)

Decorative Top

- Can be installed on fan grille

Heat Pumps

<u>S</u>	<u>P</u>	<u>14</u>	<u>24</u>	<u>F</u>	<u>J</u>	<u>1</u>	<u>N</u>	<u>A</u>
Brand	Product Category	SEER	Capacity BTU/HR	Major Series*	Voltage	Type	Controls	Minor Series**
Sure Comfort	P - Heat Pump	14 - 14 SEER	18 - 18,000 [5.28 kW] 24 - 24,000 [7.03 kW] 30 - 30,000 [8.79 kW] 36 - 36,000 [10.55 kW] 42 - 42,000 [12.31 kW] 48 - 48,000 [14.07 kW] 60 - 60,000 [17.58 kW]	A - 1st Design B - 2nd Design F - Reverse Furnace Coil/PSH AHU Series G - PSC AHU/Furnace Coil 2nd Design Series	J - 1ph, 208-230/60 C - 3ph, 208-230/60	1 - Single-stage	N - Non-communicating	A - 1st Design

[] Designates Metric Conversions

Physical Data							
Model No. #	SP1418F	SP1424F	SP1430F	SP1436F	SP1442G	SP1448F	SP1460F
Nominal Tonnage	1.5	2.0	2.5	3.0	3.5	4.0	5.0
Valve Connections							
Liquid Line O.D. – in.	3/8	3/8	3/8	3/8	3/8	3/8	3/8
Suction Line O.D. – in.	3/4	3/4	3/4	3/4	7/8	7/8	7/8
Refrigerant (R410A) furnished oz. ¹	99	105	116	118	188	108	217
Compressor Type	Scroll						
Outdoor Coil							
Net face area – Outer Coil	9.1	11.1	17.3	19.8	24.2	24.2	28.3
Net face area – Inner Coil	—	—	—	—	—	—	—
Tube diameter – in.	3/8	3/8	3/8	3/8	3/8	3/8	3/8
Number of rows	1	1	1	1	1	1	1
Fins per inch	20	20	20	20	20	20	20
Outdoor Fan							
Diameter – in.	20	20	24	24	26	26	26
Number of blades	2	3	3	3	3	3	3
Motor hp	1/8	1/8	1/5	1/3	1/3	1/3	1/5
CFM	2410	2480	3850	3120	4900	4380	3654
RPM	1077	1075	825	910	800	870	850
watts	151	138	197	134	228	265	274
Shipping weight – lbs.	156	159	198	206	220	264	285
Operating weight – lbs.	149	152	191	199	213	257	278

Electrical Data							
Line Voltage Data (Volts-Phase-Hz)	208/230-1-60	208/230-1-60	208/230-1-60	208/230-1-60	208/230-1-60	208/230-1-60	208/230-1-60
Maximum overcurrent protection (amps) ²	20	25	25	35	40	40	50
Minimum circuit ampacity ³	12	15	18	23	24	26	31
Compressor							
Rated load amps	9	10.9	12.8	15.4	17.9	18.5	23.7
Locked rotor amps	47.5	62.9	67.8	83.9	112	124	152.5
Condenser Fan Motor							
Full load amps	0.7	0.7	1	2.8	1	2.8	1
Locked rotor amps	1.2	1.3	1.2	—	1.2	—	2.3
Line Voltage Data (Volts-Phase-Hz)	—	—	—	208/230-3-60	208/230-3-60	208/230-3-60	208/230-3-60
Maximum overcurrent protection (amps) ²	—	—	—	25	30	30	35
Minimum circuit ampacity ³	—	—	—	16	18	21	21
Compressor							
Rated load amps	—	—	—	10.4	13.5	13.8	15.9
Locked rotor amps	—	—	—	73	88	83.1	110

¹Refrigerant charge sufficient for 15 ft. length of refrigerant lines. For longer line set requirements see the installation instructions for information about set length and additional refrigerant charge required.

²HACR type circuit breaker or fuse.

³Refer to National Electrical Code manual to determine wire, fuse and disconnect size requirements.

Accessories

Model No.		SP1418G	SP1424F	SP1430F	SP1436F	SP1442G	SP1448F	SP1460F
Compressor crankcase heater		44-17402-44	44-17402-44	44-17402-44	44-17402-44	44-17402-45	Factory Standard	Factory Standard
Low ambient control		RXAD-A08	RXAD-A08	RXAD-A08	RXAD-A08	RXAD-A08	RXAD-A08	RXAD-A08
Compressor sound cover		68-23427-26	68-23427-26	68-23427-26	68-23427-26	68-23427-25	68-23427-25	68-23427-25
Compressor hard start kit		SK-A1	SK-A1	SK-A1	SK-A1	SK-A1	SK-A1	SK-A1
Low pressure control*		Factory Standard	Factory Standard	Factory Standard	Factory Standard	Factory Standard	Factory Standard	Factory Standard
High pressure control*		Factory Standard	Factory Standard	Factory Standard	Factory Standard	Factory Standard	Factory Standard	Factory Standard
Liquid Line Solenoid (24 VAC, 50/60 Hz)	Solenoid Valve	200RD2T3TVLC	200RD2T3TVLC	200RD2T3TVLC	200RD2T3TVLC	200RD2T3TVLC	200RD3T3TVLC	200RD3T3TVLC
	Solenoid Coil	61-AMG24V	61-AMG24V	61-AMG24V	61-AMG24V	61-AMG24V	61-AMG24V	61-AMG24V
	Bi-flow kit*	KS30387	KS30387	KS30387	KS30387	KS30387	KS30387	KS30387
Liquid Line Solenoid (120/240 VAC, 50/60 Hz)	Solenoid Valve	200RD2T3TVLC	200RD2T3TVLC	200RD2T3TVLC	200RD2T3TVLC	200RD2T3TVLC	200RD3T3TVLC	200RD3T3TVLC
	Solenoid Coil	61-AMG120/240V	61-AMG120/240V	61-AMG120/240V	61-AMG120/240V	61-AMG120/240V	61-AMG120/240V	61-AMG120/240V
	Bi-flow kit*	KS30387	KS30387	KS30387	KS30387	KS30387	KS30387	KS30387
Heat Pump Riser – 6 inch		686020	686020	686020	686020	686020	686020	686020

*Bi-flow kits are required when installing a liquid line solenoid on a heat pump.

Weighted Sound Power Level (dBA)

Unit Size – Voltage, Series	Standard Rating (dBA)	TYPICAL OCTAVE BAND SPECTRUM (dBA without tone adjustment)						
		125	250	500	1000	2000	4000	8000
(-)P1418G	76.4	53.7	61.8	66.2	66.8	62.9	58	52
(-)P1424F	75.8	53.9	60.6	65.8	66.4	63.0	57.8	50.2
(-)P1430F	73.3	51.8	56.6	63.4	62.9	60.8	55.9	51.5
(-)P1436F	74.7	48.9	54.3	63.1	66.4	62.2	53.2	53.2
(-)P1442G	74.1	52.9	55.9	64	63.5	61.4	58	52.1
(-)P1448F	76.5	55.8	59	68.2	66.3	64.3	60.5	55.4
(-)P1460F	73.9	58.9	55.7	63.4	63.3	61.5	58.6	56.4

NOTE: Tested in accordance with AHRI Standard 270-08 (not listed in AHRI)

Unit Dimensions

MODEL NUMBER	OPERATING						SHIPPING					
	H (Height)		L (Length)		W (Width)		H (Height)		L (Length)		W (Width)	
	INCHES	mm	INCHES	mm	INCHES	mm	INCHES	mm	INCHES	mm	INCHES	mm
(-)P1418G	25	635	29.75	755	29.75	755	26.5	673	32.38	822	32.38	822
(-)P1424F	25	635	29.75	755	29.75	755	26.5	673	32.38	822	32.38	822
(-)P1430F	31	787	33.75	857	33.75	857	32.5	826	36.38	924	36.38	924
(-)P1436F	35	889	33.75	857	33.75	857	36.5	927	36.38	924	36.38	924
(-)P1442G	39	990	35.75	908	35.75	908	40.5	1029	38.38	974	38.38	974
(-)P1448F	39	990	35.75	908	35.75	908	40.5	1029	38.38	974	38.38	974
(-)P1460F	45	1143	35.75	908	35.75	908	46.5	1181	38.38	974	38.38	974

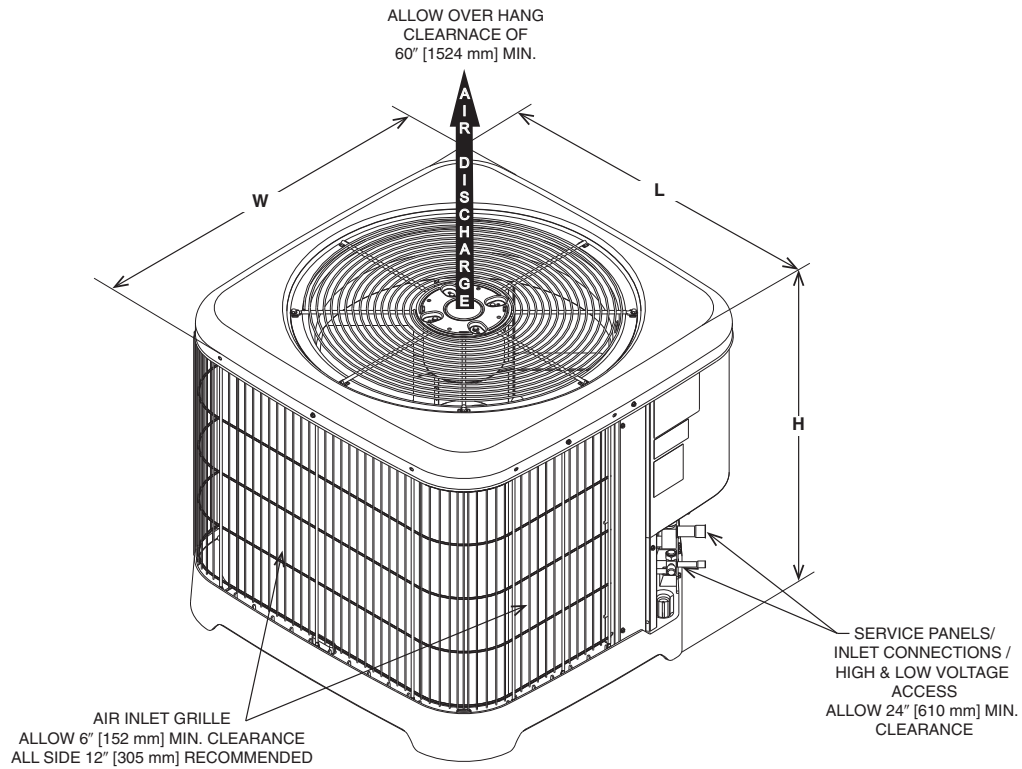

[] Designates Metric Conversions

ST-A1226-24-00

CLEARANCES

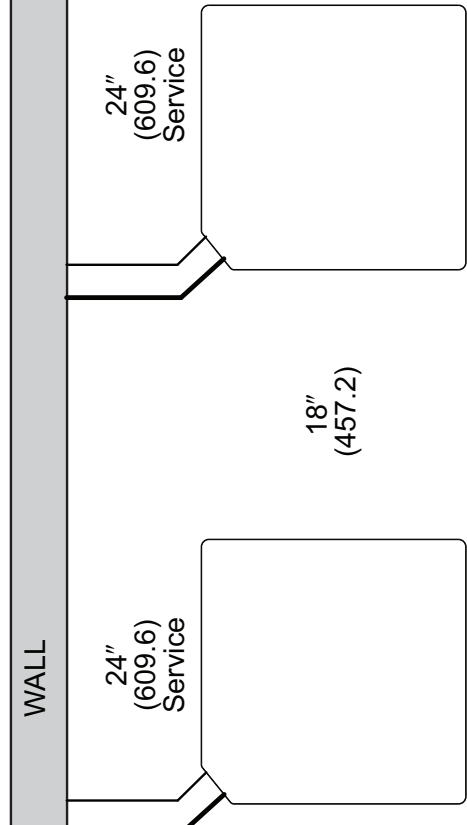
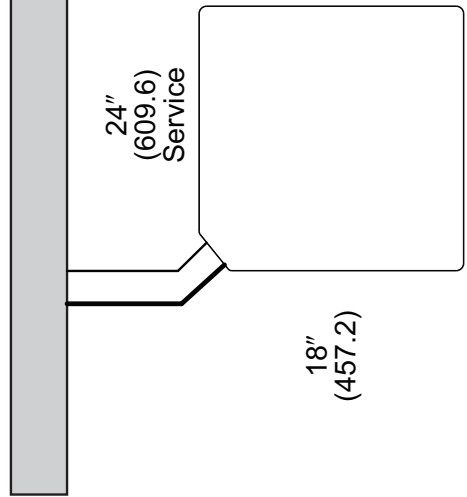
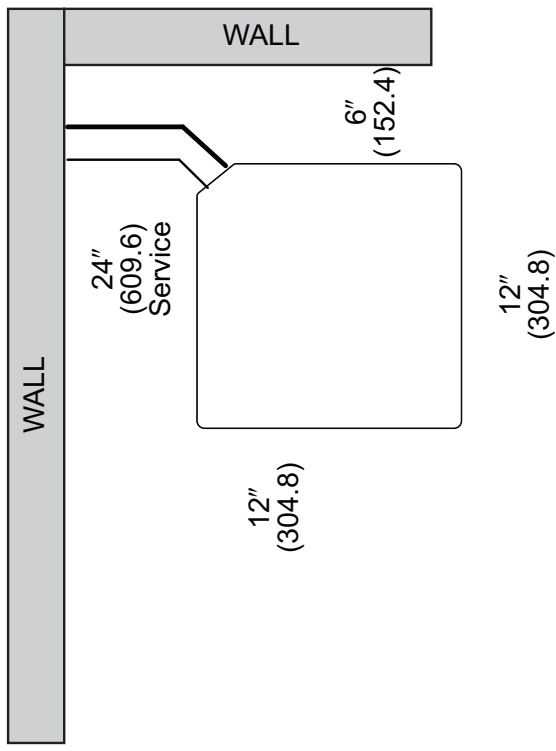
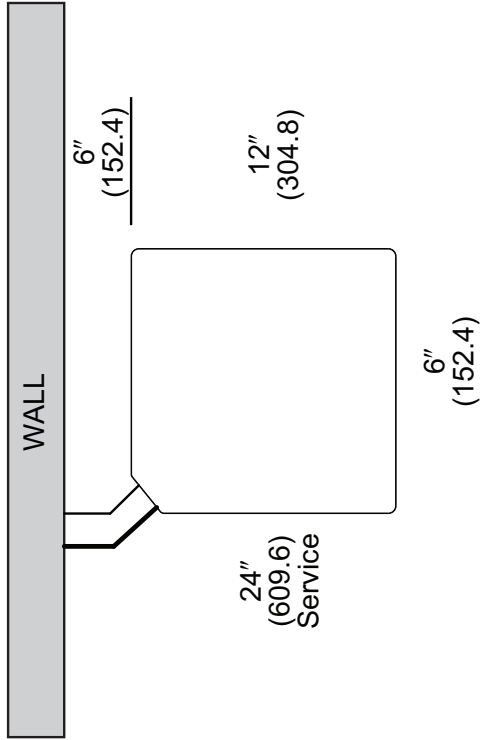

NOTE: NUMBERS IN () = mm

IMPORTANT: When installing multiple units in an alcove, roof well or partially enclosed area, ensure there is adequate ventilation to prevent re-circulation of discharge air.

Control Wiring

FIGURE 4
CONTROL WIRING FOR AIR HANDLER

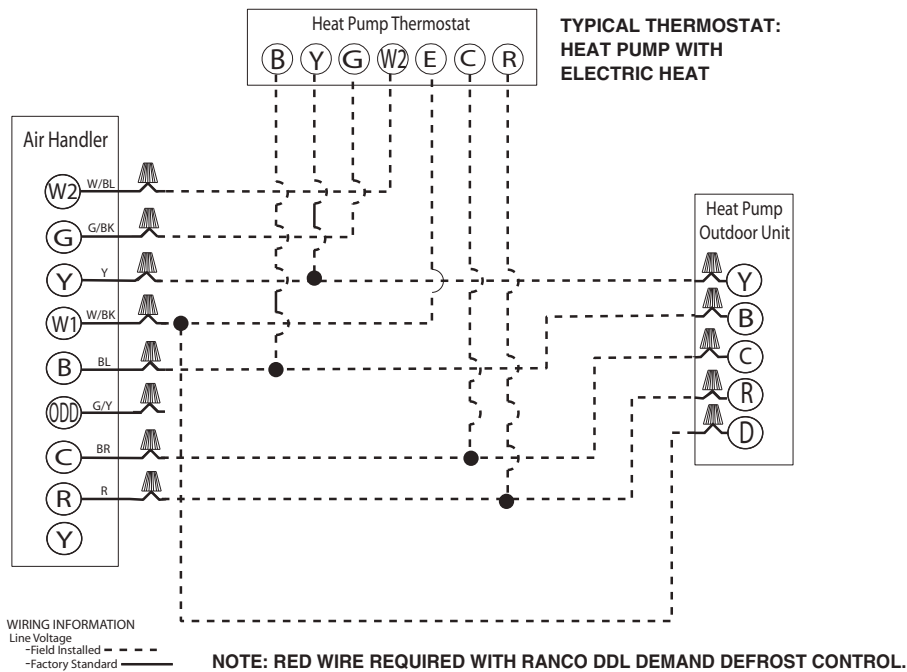

NOTES:

1. Jumper "E" to "W2" to transfer control of supplemental heat to 1st stage when the emergency heat switch is on.
2. This wire turns on heat for defrost, omit for most economical operation.
3. Wire with colored tracing stripe.

System Design Summary:

1. Intended for outdoor installation with free air inlet and outlet. Outdoor fan external static pressure available is less than 0.01 -in. wc.
2. Minimum outdoor operation air temperature for cooling mode without low-ambient operation accessory is 55°F (12.8°C).
3. Maximum outdoor operating air temperature is 125°F (51.7°C).
4. For reliable operation, unit should be level in all horizontal planes.
5. For interconnecting refrigerant tube lengths greater than 150 ft. (45.72m) and/or 120 ft. (36.58m) vertical separation, consult Residential Piping and Long line guide. Located on MyRheem.com PTS.
6. If any refrigerant tubing is buried, provide a 8 in. (203.2mm) vertical rise to the valve connections at the unit. Refrigerant tubing lengths up to 8 ft. (2.44m) may be buried without further consideration. Do not bury refrigerant lines longer than * in (* mm).
7. Use only copper wire for electric connections at unit. Aluminum and clad aluminum are not acceptable for the type of connector provided.
8. Do not apply capillary tube indoor coils to these units.
9. Factory-supplied filter drier must be installed.

Refrigerant Line Sizing Chart (English Units)

14 SEER Single-Stage Heat Pumps																					
Unit Size	Allowable Liquid Line Size	Allowable Vapor Line Size	Apply Long Line Guidelines if Linear Line Length Exceeds Those Shown Below (Feet) (-)P14-F	Outdoor Unit ABOVE or BELOW Indoor Unit Equivalent Length (Feet)																	
				< 25	26-50	51-75	76-100	101-125	126-150	151-175	176-200	201-225	226-250								
				Maximum Vertical Separation / Capacity Multiplier																	
1.5 Ton* SEE NOTE 3	1/4"	5/8"	98	25/1.00	50/0.99	62/0.98	43/0.98	24/0.97	5/0.97	N/R	N/R	N/R	N/R	N/R	N/R	N/R	N/R	N/R	N/R	N/R	
	5/16"	5/8"	78	25/1.00	50/0.99	75/0.98	98/0.98	93/0.97	88/0.97	83/0.96	78/0.96	73/0.95	68/0.94	100/0.94	100/0.94	100/0.94	100/0.94	100/0.94	100/0.94	100/0.94	100/0.94
	3/8"	5/8"	57	25/1.00	50/0.99	75/0.98	100/0.98	100/0.97	100/0.97	100/0.97	100/0.96	100/0.95	100/0.94	100/0.94	100/0.94	100/0.94	100/0.94	100/0.94	100/0.94	100/0.94	100/0.94
	1/4"	3/4**	98	25/1.00	50/1.00	62/0.99	43/0.99	24/0.99	5/0.99	N/R	N/R	N/R	N/R	N/R	N/R	N/R	N/R	N/R	N/R	N/R	N/R
	5/16"	3/4**	78	25/1.00	50/1.00	75/0.99	98/0.99	93/0.99	88/0.99	83/0.99	78/0.98	73/0.98	68/0.98	100/0.98	100/0.98	100/0.98	100/0.98	100/0.98	100/0.98	100/0.98	100/0.98
	3/8"	3/4**	57	25/1.00	50/1.00	75/1.00	100/0.99	100/0.99	100/0.99	100/0.99	100/0.99	100/0.98	100/0.98	100/0.98	100/0.98	100/0.98	100/0.98	100/0.98	100/0.98	100/0.98	100/0.98
2 Ton	1/4"	5/8"	N/A	25/0.99	50/0.98	21/0.97	N/R	N/R	N/R	N/R	N/R	N/R	N/R	N/R	N/R	N/R	N/R	N/R	N/R	N/R	
	5/16"	5/8"	123	25/0.99	50/0.98	75/0.97	87/0.96	77/0.95	69/0.94	61/0.93	53/0.92	45/0.91	37/0.90	90/0.90	90/0.90	90/0.90	90/0.90	90/0.90	90/0.90	90/0.90	
	3/8"	5/8"	82	25/0.99	50/0.98	75/0.97	100/0.96	100/0.95	100/0.94	98/0.93	95/0.92	93/0.91	90/0.90	100/0.90	100/0.90	100/0.90	100/0.90	100/0.90	100/0.90	100/0.90	
	1/4"	3/4"	N/A	25/1.00	50/1.00	21/0.99	N/R	N/R	N/R	N/R	N/R	N/R	N/R	N/R	N/R	N/R	N/R	N/R	N/R	N/R	
	5/16"	3/4"	123	25/1.00	50/1.00	75/0.99	87/0.99	77/0.98	69/0.98	61/0.98	53/0.97	45/0.97	37/0.96	90/0.96	90/0.96	90/0.96	90/0.96	90/0.96	90/0.96	90/0.96	
	3/8"	3/4"	82	25/1.00	50/1.00	75/0.99	100/0.99	100/0.99	100/0.99	100/0.98	95/0.97	93/0.97	90/0.96	100/0.96	100/0.96	100/0.96	100/0.96	100/0.96	100/0.96	100/0.96	
2.5 Ton	5/16"	5/8"	103	25/0.99	50/0.98	75/0.96	70/0.94	59/0.93	48/0.91	36/0.90	N/R	N/R	N/R	N/R	N/R	N/R	N/R	N/R	N/R		
	3/8"	5/8"	68	25/0.99	50/0.98	75/0.96	100/0.94	98/0.93	94/0.91	90/0.90	N/R	N/R	N/R	N/R	N/R	N/R	N/R	N/R	N/R		
	5/16"	3/4"	103	25/1.00	50/0.99	75/0.99	70/0.98	59/0.98	48/0.97	36/0.96	25/0.96	13/0.95	N/R	N/R	N/R	N/R	N/R	N/R	N/R		
	3/8"	3/4"	68	25/1.00	50/0.99	75/0.99	100/0.98	98/0.98	94/0.97	90/0.96	86/0.96	82/0.95	78/0.95	78/0.95	78/0.95	78/0.95	78/0.95	78/0.95	78/0.95		
	5/16"	5/8"	98	25/0.99	50/0.97	66/0.94	49/0.92	32/0.90	N/R	N/R	N/R	N/R	N/R	N/R	N/R	N/R	N/R	N/R	N/R		
	3/8"	5/8"	65	25/0.99	50/0.97	75/0.94	95/0.92	89/0.90	N/R	N/R	N/R	N/R	N/R	N/R	N/R	N/R	N/R	N/R	N/R		
3 Ton	5/16"	3/4"	98	25/1.00	50/0.99	66/0.98	49/0.98	32/0.97	15/0.96	N/R	N/R	N/R	N/R	N/R	N/R	N/R	N/R	N/R			
	3/8"	3/4"	65	25/1.00	50/0.99	75/0.98	95/0.98	89/0.97	84/0.96	78/0.95	72/0.94	67/0.93	61/0.93	100/0.93	100/0.93	100/0.93	100/0.93	100/0.93			
	1/2"	3/4"	33	25/1.00	50/0.99	75/0.98	100/0.98	100/0.97	100/0.96	100/0.95	100/0.94	100/0.93	100/0.93	100/0.93	100/0.93	100/0.93	100/0.93	100/0.93			
	5/16"	7/8"	98	25/1.00	50/1.00	66/1.00	49/0.99	32/0.99	15/0.99	N/R	N/R	N/R	N/R	N/R	N/R	N/R	N/R	N/R			
	3/8"	7/8"	65	25/1.00	50/1.00	75/1.00	95/0.99	89/0.99	84/0.99	78/0.98	72/0.98	67/0.98	61/0.97	100/0.97	100/0.97	100/0.97	100/0.97	100/0.97			
	1/2"	7/8"	33	25/1.00	50/1.00	75/1.00	100/0.99	100/0.99	100/0.99	100/0.99	100/0.98	100/0.98	100/0.98	100/0.98	100/0.98	100/0.98	100/0.98	100/0.98			
3.5 Ton	3/8"	3/4"	93	25/0.99	50/0.98	75/0.97	88/0.96	80/0.95	72/0.94	65/0.92	57/0.91	49/0.90	N/R	N/R	N/R	N/R	N/R				
	1/2"	3/4"	47	25/0.99	50/0.98	75/0.97	100/0.96	100/0.95	100/0.94	100/0.92	100/0.91	100/0.90	N/R	N/R	N/R	N/R	N/R				
	3/8"	7/8"	93	25/1.00	50/1.00	75/0.99	88/0.99	80/0.99	72/0.98	65/0.97	57/0.97	49/0.96	42/0.96	100/0.96	100/0.96	100/0.96	100/0.96				
	1/2"	7/8"	47	25/1.00	50/1.00	75/0.99	100/0.99	100/0.99	100/0.99	100/0.99	100/0.97	100/0.97	100/0.97	100/0.97	100/0.97	100/0.97	100/0.97				

- Notes:
- 1) Do not exceed 200 ft linear line length.
 - 2) Do not exceed 100 ft vertical separation between indoor and outdoor units.
 - 3) *3/4" vapor line should only be used for 1.5 ton systems if outdoor unit is below or at same level as indoor unit to assure proper oil return.
 - 4) Always use the smallest liquid line allowable to minimize refrigerant charge.
 - 5) Applications shaded in light gray indicate capacity multipliers between 0.90 and 0.96 which are not recommended, but are allowed.
 - 6) Applications shaded in dark gray are not recommended due to excessive liquid or suction line pressure drop.

Refrigerant Line Sizing Chart (English Units) (con't.)

14 SEER Single-Stage Heat Pumps													
Unit Size	Allowable Liquid Line Size	Allowable Vapor Line Size	Apply Long Line Guidelines if Linear Line Length Exceeds Those Shown Below (Feet) (-)P14-F	Outdoor Unit ABOVE or BELOW Indoor Unit Equivalent Length (Feet)									
				< 25	26-50	51-75	76-100	101-125	126-150	151-175	176-200	201-225	226-250
				Maximum Vertical Separation / Capacity Multiplier									
4 Ton	3/8"	3/4"	0	25 / 0.99	50 / 0.98	75 / 0.96	77 / 0.95	67 / 0.93	57 / 0.92	46 / 0.91	N/R	N/R	N/R
	1/2"	3/4"	0	25 / 0.99	50 / 0.98	75 / 0.96	100 / 0.95	100 / 0.93	100 / 0.92	100 / 0.91	N/R	N/R	N/R
	3/8"	7/8"	0	25 / 1.00	50 / 0.99	75 / 0.99	77 / 0.98	67 / 0.97	57 / 0.97	46 / 0.96	36 / 0.96	26 / 0.95	15 / 0.95
	1/2"	7/8"	0	25 / 1.00	50 / 0.99	75 / 0.99	100 / 0.98	100 / 0.97	100 / 0.97	100 / 0.96	100 / 0.96	99 / 0.95	97 / 0.95
	3/8"	3/4"	0	25 / 0.99	50 / 0.97	75 / 0.94	61 / 0.92	46 / 0.90	N/R	N/R	N/R	N/R	N/R
	1/2"	3/4"	0	25 / 0.99	50 / 0.97	75 / 0.94	100 / 0.92	100 / 0.90	N/R	N/R	N/R	N/R	N/R
5 Ton	3/8"	7/8"	0	25 / 1.00	50 / 0.99	75 / 0.98	61 / 0.97	46 / 0.96	32 / 0.95	18 / 0.94	N/R	N/R	N/R
	1/2"	7/8"	0	25 / 1.00	50 / 0.99	75 / 0.98	100 / 0.97	100 / 0.96	100 / 0.95	97 / 0.94	95 / 0.94	92 / 0.93	89 / 0.92
	3/8"	1-1/8"	0	25 / 1.01	50 / 1.01	75 / 1.00	61 / 1.00	46 / 0.99	32 / 0.99	18 / 0.99	N/R	N/R	N/R
	1/2"	1-1/8"	0	25 / 1.01	50 / 1.01	75 / 1.00	100 / 1.00	100 / 0.99	100 / 0.99	97 / 0.99	95 / 0.99	92 / 0.99	89 / 0.98

Notes:

- 1) Do not exceed 200 ft linear line length.
- 2) Do not exceed 100 ft vertical separation between indoor and outdoor units.
- 3) 3/4" vapor line should only be used for 1.5 ton systems if outdoor unit is below or at same level as indoor unit to assure proper oil return.
- 4) Always use the smallest liquid line allowable to minimize refrigerant charge.
- 5) Applications shaded in light gray indicate capacity multipliers between 0.90 and 0.96 which are not recommended, but are allowed.
- 6) Applications shaded in dark gray are not recommended due to excessive liquid or suction line pressure drop.

Refrigerant Line Sizing Chart (Metric Units)

14 SEER Single-Stage Heat Pumps																	
Unit Size	Allowable Liquid Line Size mm [in.]	Allowable Vapor Line Size mm [in]	Apply Long Line Guidelines If Linear Line Length Exceeds Those Shown Below (Meters) (-)P14-F	Outdoor Unit ABOVE or BELOW Indoor Unit Equivalent Length (Meters)													
				< 8	8-15	16-23	24-30	31-38	39-46	47-53	54-61	62-69	70-76				
				Maximum Vertical Separation / Capacity Multiplier													
5.3 kW [1.5 Ton] **SEE NOTE 3	6.35 [1/4]	15.88 [5/8]	30	8/1.00	15/0.99	19/0.98	13/0.98	7/0.97	2/0.97	N/R	N/R	N/R	N/R	N/R	N/R	N/R	
	7.94 [5/16]	15.88 [5/8]	24	8/1.00	15/0.99	23/0.98	30/0.98	28/0.97	27/0.97	25/0.96	24/0.96	22/0.95	21/0.94				
	9.53 [3/8]	15.88 [5/8]	17	8/1.00	15/0.99	23/0.98	30/0.98	30/0.97	30/0.97	30/0.96	30/0.96	30/0.95	30/0.94				
	6.35 [1/4]	19.05 [3/4]*	30	8/1.00	15/1.00	19/0.99	13/0.99	7/0.99	2/0.99	N/R	N/R	N/R	N/R	N/R			
	7.94 [5/16]	19.05 [3/4]*	24	8/1.00	15/1.00	23/0.99	30/0.99	28/0.99	27/0.99	25/0.99	24/0.98	22/0.98	21/0.98				
	9.53 [3/8]	19.05 [3/4]*	17	8/1.00	15/1.00	23/0.99	30/0.99	30/0.99	30/0.99	30/0.99	30/0.99	30/0.98	30/0.98				
7.0 kW [2 Ton]	6.35 [1/4]	15.88 [5/8]	N/A	8/0.99	15/0.98	6/0.97	N/R	N/R	N/R	N/R	N/R	N/R	N/R	N/R	N/R	N/R	
	7.94 [5/16]	15.88 [5/8]	37	8/0.99	15/0.98	23/0.97	27/0.96	23/0.95	21/0.94	19/0.93	16/0.92	14/0.91	11/0.90				
	9.53 [3/8]	15.88 [5/8]	25	8/0.99	15/0.98	23/0.97	30/0.96	30/0.95	30/0.94	30/0.93	29/0.92	28/0.91	27/0.90				
	6.35 [1/4]	19.05 [3/4]	N/A	8/1.00	15/1.00	6/0.99	N/R	N/R	N/R	N/R	N/R	N/R	N/R	N/R	N/R	N/R	
	7.94 [5/16]	19.05 [3/4]	37	8/1.00	15/1.00	23/0.99	27/0.99	23/0.98	21/0.98	19/0.98	16/0.97	14/0.97	11/0.96				
	9.53 [3/8]	19.05 [3/4]	25	8/1.00	15/1.00	23/0.99	30/0.99	30/0.99	30/0.98	30/0.98	29/0.97	28/0.97	27/0.96				
8.8 kW [2.5 Ton]	7.94 [5/16]	15.88 [5/8]	31	8/0.99	15/0.98	23/0.96	21/0.94	18/0.93	15/0.91	11/0.90	N/R	N/R	N/R	N/R	N/R	N/R	
	9.53 [3/8]	15.88 [5/8]	21	8/0.99	15/0.98	23/0.96	30/0.94	30/0.93	29/0.91	27/0.90	N/R	N/R	N/R	N/R	N/R	N/R	
	7.94 [5/16]	19.05 [3/4]	31	8/1.00	15/0.99	23/0.99	21/0.98	18/0.98	15/0.97	11/0.96	8/0.96	4/0.95	N/R	N/R	N/R	N/R	
	9.53 [3/8]	19.05 [3/4]	21	8/1.00	15/0.99	23/0.99	30/0.98	30/0.98	29/0.97	27/0.96	26/0.96	25/0.95	24/0.95	24/0.95	24/0.95	24/0.95	
	7.94 [5/16]	15.88 [5/8]	30	8/0.99	15/0.97	20/0.94	15/0.92	10/0.90	N/R	N/R	N/R	N/R	N/R	N/R	N/R	N/R	N/R
	9.53 [3/8]	15.88 [5/8]	20	8/0.99	15/0.97	23/0.94	29/0.92	27/0.90	N/R	N/R	N/R	N/R	N/R	N/R	N/R	N/R	N/R
10.6 kW [3 Ton]	7.94 [5/16]	19.05 [3/4]	30	8/1.00	15/0.99	20/0.98	15/0.98	10/0.97	5/0.96	N/R	N/R	N/R	N/R	N/R	N/R	N/R	
	9.53 [3/8]	19.05 [3/4]	20	8/1.00	15/0.99	23/0.98	29/0.98	27/0.97	26/0.96	24/0.95	22/0.94	20/0.93	19/0.93				
	12.7 [1/2]	19.05 [3/4]	10	8/1.00	15/0.99	23/0.98	30/0.98	30/0.97	30/0.96	30/0.95	30/0.94	30/0.93	30/0.93				
	7.94 [5/16]	22.23 [7/8]	30	8/1.00	15/1.00	20/1.00	15/0.99	10/0.99	5/0.99	N/R	N/R	N/R	N/R	N/R	N/R	N/R	
	9.53 [3/8]	22.23 [7/8]	20	8/1.00	15/1.00	23/1.00	29/0.99	27/0.99	26/0.99	24/0.98	22/0.98	20/0.98	19/0.97				
	12.7 [1/2]	22.23 [7/8]	10	8/1.00	15/1.00	23/1.00	30/0.99	30/0.99	30/0.99	30/0.98	30/0.98	30/0.98	30/0.97				
12.3 kW [3.5 Ton]	9.53 [3/8]	19.05 [3/4]	28	8/0.99	15/0.98	23/0.97	27/0.96	24/0.95	22/0.94	20/0.92	17/0.91	15/0.90	N/R	N/R	N/R	N/R	
	12.7 [1/2]	19.05 [3/4]	14	8/0.99	15/0.98	23/0.97	30/0.96	30/0.95	30/0.94	30/0.92	30/0.91	30/0.90	N/R	N/R	N/R	N/R	
	9.53 [3/8]	22.23 [7/8]	28	8/1.00	15/1.00	23/0.99	27/0.99	24/0.99	22/0.98	20/0.97	17/0.97	15/0.96	13/0.96				
	12.7 [1/2]	22.23 [7/8]	14	8/1.00	15/1.00	23/0.99	30/0.99	30/0.99	30/0.98	30/0.97	30/0.97	30/0.96	30/0.96				
	9.53 [3/8]	19.05 [3/4]	28	8/0.99	15/0.98	23/0.97	27/0.96	24/0.95	22/0.94	20/0.92	17/0.91	15/0.90	N/R	N/R	N/R	N/R	
	12.7 [1/2]	22.23 [7/8]	14	8/1.00	15/1.00	23/0.99	30/0.99	30/0.99	30/0.98	30/0.97	30/0.97	30/0.96	30/0.96				

- Notes:
- 1) Do not exceed 61 meters linear line length.
 - 2) Do not exceed 30 meters vertical separation between indoor and outdoor units.
 - 3) *19.05mm [3/4 in.] vapor line should only be used for 1.5 ton systems if outdoor unit is below or at same level as indoor unit to assure proper oil return.
 - 4) Always use the smallest liquid line allowable to minimize refrigerant charge.
 - 5) Applications shaded in light gray indicate capacity multipliers between 0.90 and 0.96 which are not recommended, but are allowed.
 - 6) Applications shaded in dark gray are not recommended due to excessive liquid or suction line pressure drop.

Refrigerant Line Sizing Chart (Metric Units) (con't.)

14 SEER Single-Stage Heat Pumps													
Unit Size	Allowable Liquid Line Size mm [in.]	Allowable Vapor Line Size mm [in.]	Apply Long Line Guidelines If Linear Line Length Exceeds Those Shown Below (Meters) (-)P14-F	Outdoor Unit ABOVE or BELOW Indoor Unit Equivalent Length (Meters)									
				< 8	8-15	16-23	24-30	31-38	39-46	47-53	54-61	62-69	70-76
				Maximum Vertical Separation / Capacity Multiplier									
14.1 kW [4 Ton]	9.53 [3/8]	19.05 [3/4]	0	8 / 0.99	15 / 0.98	23 / 0.96	24 / 0.95	20 / 0.93	17 / 0.92	14 / 0.91	N/R	N/R	N/R
	12.7 [1/2]	19.05 [3/4]	0	8 / 0.99	15 / 0.98	23 / 0.96	30 / 0.95	30 / 0.93	30 / 0.92	30 / 0.91	N/R	N/R	N/R
	9.53 [3/8]	22.23 [7/8]	0	8 / 1.00	15 / 0.99	23 / 0.99	24 / 0.98	20 / 0.97	17 / 0.97	14 / 0.96	11 / 0.96	8 / 0.95	5 / 0.95
	12.7 [1/2]	22.23 [7/8]	0	8 / 1.00	15 / 0.99	23 / 0.99	30 / 0.98	30 / 0.97	30 / 0.97	30 / 0.96	30 / 0.95	30 / 0.95	30 / 0.95
17.6 kW [5 Ton]	9.53 [3/8]	19.05 [3/4]	0	8 / 0.99	15 / 0.97	23 / 0.94	19 / 0.92	14 / 0.90	N/R	N/R	N/R	N/R	N/R
	12.7 [1/2]	19.05 [3/4]	0	8 / 0.99	15 / 0.97	23 / 0.94	30 / 0.92	30 / 0.90	N/R	N/R	N/R	N/R	N/R
	9.53 [3/8]	22.23 [7/8]	0	8 / 1.00	15 / 0.99	23 / 0.98	19 / 0.97	14 / 0.96	10 / 0.95	5 / 0.94	N/R	N/R	N/R
	12.7 [1/2]	22.23 [7/8]	0	8 / 1.00	15 / 0.99	23 / 0.98	30 / 0.97	30 / 0.96	30 / 0.95	30 / 0.94	29 / 0.94	28 / 0.93	27 / 0.92
	9.53 [3/8]	28.58 [1-1/8]	0	8 / 1.01	15 / 1.01	23 / 1.00	19 / 1.00	14 / 0.99	10 / 0.99	5 / 0.99	N/R	N/R	N/R
	12.7 [1/2]	28.58 [1-1/8]	0	8 / 1.01	15 / 1.01	23 / 1.00	30 / 1.00	30 / 0.99	30 / 0.99	30 / 0.99	29 / 0.99	28 / 0.99	27 / 0.98

Notes:

- 1) Do not exceed 61 meters linear line length.
- 2) Do not exceed 30 meters vertical separation between indoor and outdoor units.
- 3) *19.05mm [3/4 in.] vapor line should only be used for 1.5 ton systems if outdoor unit is below or at same level as indoor unit to assure proper oil return.
- 4) Always use the smallest liquid line allowable to minimize refrigerant charge.
- 5) Applications shaded in light gray indicate capacity multipliers between 0.90 and 0.96 which are not recommended, but are allowed.
- 6) Applications shaded in dark gray are not recommended due to excessive liquid or suction line pressure drop.

Performance Data @ AHRI Standard Conditions – Heat Pump

Designated Tested Combination (DTC)												
Outdoor Unit	Air Handler	Total Capacity BTU/H [kW]	Net Sensible BTU/H [kW]	Net Latent BTU/H [kW]	SEER	EER	Indoor CFM [L/s]	47 Degree Heating Capacity BTU/H [kW]	47 Degree COP	17 Degree Heating Capacity BTU/H [kW]	17 Degree COP	Region IV HSPF
SP1424F-J1	SH1C2417STAN	24000 [7.0]	17900 [5.2]	6100 [1.8]	14.50	12.00	800 [377.6]	22000 [6.4]	3.70	13500 [4.0]	2.50	8.50
SP1430F-J1	SH1C3617STAN	29400 [8.6]	22500 [6.6]	6900 [2.0]	14.50	12.00	1025 [483.7]	27000 [7.9]	3.70	16600 [4.9]	2.40	8.50
SP1436F-J1	SH1C3617STAN	35600 [10.4]	26400 [7.7]	9200 [2.7]	14.50	12.00	1175 [554.5]	33800 [9.9]	3.66	22400 [6.6]	2.66	8.50
SP1442F-J1	SH1C4821STAN	42500 [12.5]	30600 [9.0]	11900 [3.5]	14.50	12.00	1350 [637.1]	40000 [11.7]	3.76	25600 [7.5]	2.60	8.50
SP1460F-J1	SH1C6024STAN	58000 [17.0]	42400 [12.4]	15600 [4.6]	14.50	12.00	1775 [837.7]	56000 [16.4]	3.76	35600 [10.4]	2.66	8.50

Note: Additional ratings and system match ups can be accessed on My.SureComfort.com at: <https://my.surecomfort.com/static/private/ahri/residential.html>
 Additional ratings and system match ups and downloadable ratings certificates can be accessed from the AHRI website: www.ahridirectory.org

[] Designates Metric Conversions

GUIDE SPECIFICATIONS

General

System Description

Outdoor-mounted, air-cooled, split-system heat pump unit suitable for ground or rooftop installation. Unit consists of a hermetic compressor, composite basepan, an air-cooled coil, propeller-type condenser fan, suction and liquid line service valve, and a control box. Unit will discharge supply air upward as shown on contract drawings. Unit will be used in a refrigeration circuit to match up to a coil unit.

Quality Assurance

- Unit will be rated in accordance with the latest edition of AHRI Standard 210.
- Unit will be certified for capacity and efficiency, and listed in the latest AHRI directory.
- Unit construction will comply with latest edition of ANSI/ASHRAE and with NEC.
- Unit will be constructed in accordance with UL standards and will carry the UL label of approval. Unit will have c-UL-us approval.
- Unit cabinet will be capable of withstanding ASTM B117 1000-hr salt spray test.
- Air-cooled condenser coils will be leak tested at 150 psig and pressure tested at 550 psig.
- Unit constructed in ISO9001 approved facility.

Delivery, Storage, and Handling

- Unit will be shipped as single package only and is stored and handled per unit manufacturer's recommendations.

Warranty (for inclusion by specifying engineer) — U.S. and Canada only.

Products

Equipment

Factory assembled, single piece, air-cooled heat pump unit. Contained within the unit enclosure is all factory wiring, piping, controls, compressor, refrigerant charge R-410A, and special features required prior to field start-up.

Unit Cabinet

- Unit cabinet will be constructed of galvanized steel, bonderized, and coated with a powder coat paint.
- All units constructed with louver coil protection and corner post. Louver can be removed by removing one fastener per louver panel.

AIR-COOLED, SPLIT-SYSTEM HEAT PUMP SP14**F

1-1/2 TO 5 NOMINAL TONS

Fans

- Condenser fan will be direct-drive propeller type, discharging air upward.
- Condenser fan motors will be totally enclosed, 1-phase type with class B insulation and permanently lubricated bearings. Shafts will be corrosion resistant.
- Fan blades will be statically and dynamically balanced.
- Condenser fan openings will be equipped with coated steel wire safety guards.

Compressor

- Compressor will be hermetically sealed.
- Compressor will be mounted on rubber vibration isolators.

Condenser Coil

- Condenser coil will be air cooled.
- Coil will be constructed of aluminum fins mechanically bonded to copper tubes.

Refrigeration Components

- Refrigeration circuit components will include liquid-line shutoff valve with sweat connections, vapor-line shutoff valve with sweat connections, system charge of R-410A refrigerant, and compressor oil.
- Unit will be equipped with filter drier for R-410A refrigerant for field installation.

Operating Characteristics

- The capacity of the unit will meet or exceed _____ Btuh at a suction temperature of _____ °F/°C. The power consumption at full load will not exceed _____ kW.
- Combination of the unit and the evaporator or fan coil unit will have a total net cooling capacity of _____ Btuh or greater at conditions of _____ CFM entering air temperature at the evaporator at _____ °F/°C wet bulb and _____ °F/°C dry bulb, and air entering the unit at _____ °F/°C.
- The system will have a SEER of _____ Btuh/watt or greater at DOE conditions.

Electrical Requirements

- Nominal unit electrical characteristics will be _____ v, single phase, 60 hz. The unit will be capable of satisfactory operation within voltage limits of _____ v to _____ v.
- Nominal unit electrical characteristics will be _____ v, three phase, 60 hz. The unit will be capable of satisfactory operation within voltage limits of _____ v to _____ v.
- Unit electrical power will be single point connection.
- Control circuit will be 24v.

Special Features

- Refer to section of this literature identifying accessories and descriptions for specific features and available enhancements.

GENERAL TERMS OF LIMITED WARRANTY*

Sure Comfort® will furnish a replacement for any part of this product which fails in normal use and service within the applicable period stated, in accordance with the terms of the limited warranty.

*For complete details of the Limited and Conditional Warranties, including applicable terms and conditions, contact your local contractor or the Manufacturer for a copy of the product warranty certificate.

Conditional Parts
(Registration Required)Ten (10) Years



Sure Comfort®
5600 Old Greenwood Road, Fort Smith, AR 72908

Before proceeding with installation, refer to installation instructions packaged with each model, as well as complying with all Federal, State, Provincial, and Local codes, regulations, and practices.