

Tankless Water Heater Controller



⚠ WARNING

If the information in this manual is not followed exactly, a fire or explosion may result causing property damage, personal injury, or loss of life.

SAFETY CONSIDERATIONS

Installation, start-up and servicing of the units must be done with due care and attention, and should only be performed by competent, qualified, licensed and trained heating technicians. Failure to read and comply with all instructions and applicable National and local codes may result in hazardous conditions that could result in property damage and injury to occupants which in extreme cases might result in death.

HAZARDS & PRECAUTIONS**⚠ DANGER**

Points out an imminently hazardous situation which must be avoided in order to prevent serious injury or death.

⚠ WARNING

Points out a potentially hazardous situation which must be avoided to prevent serious injury or death.

⚠ CAUTION

Points out a potentially hazardous situation which must be avoided to prevent possible moderate injury and/or property damage

⚠ NOTE

Points out installation, maintenance and operation details that will result in enhanced efficiency, longevity and proper operation of your boiler.

⚠ BEST PRACTICES

Points out recommendations for better installation.

CONTENTS

CONTROL OPERATION	1-1
INTERFACE INDICATORS/BUTTONS	1-1
MAIN MENU	1-2
ACCESSING THE MAIN MENU	1-2
OPERATIONAL MODES	1-3
ADJUSTMENT MENUS	1-5
ADJUSTING THE DHW TEMPERATURE	1-5
ADJUSTING THE DHW MODES	1-6
ACCESSING THE SERVICE MENU	1-6
TESTING THE UNIT FIRING RATE	1-8
ACCESSING THE INFORMATION MENU	1-9
ACCESSING PARAMETER MENUS TO CHANGE CONTROLLER PARAMETERS	1-10
ACCESSING THE INSTALLER PARAMETER MENU	1-11
ACCESSING THE ADVANCED PARAMETER MENU	1-15
ACCESSING THE CASCADE MENU	1-22
CASCADE FUNCTION	1-26
TANKLESS WATER HEATER CASCADE SYSTEM	1-26
TANKLESS WATER HEATER AND COMBI BOILER CASCADE SySTEM	1-27
LOW VOLTAGE WIRING	1-28
LINE VOLTAGE WIRING	1-28
CASCADE CONFIGURATION	1-28
CASCADE COMMUNICATION	1-29
CASCADE ADJUSTMENTS	1-29
RECIRCULATION FUNCTION	1-30
RECIRCULATION PIPING	1-30
LINE VOLTAGE WIRING	1-31
RECIRCULATION CONFIGURATION	1-31
SETTING THE CLOCK	1-32
SETTING THE DHW RECIRCULATION TIMES	1-33
REMOVING & WIRING THE CONTROLLER	1-36
REMOVING THE CONTROLLER	1-36
WIRING THE CONTROLLER	1-37
120VAC LINE VOLTAGE HOOK-UP	1-37
SEQUENCE OF OPERATION	1-38
TEMPERATURE SENSORS	1-39
TROUBLESHOOTING	1-40
FAULT CODES	1-40
NOTIFICATION CODES	1-44

! **DANGER**

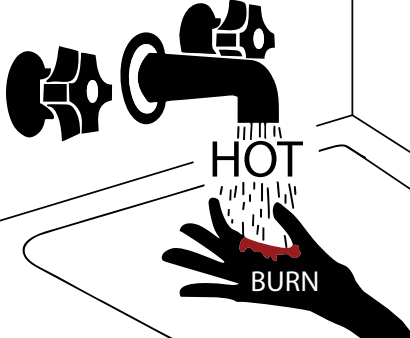

- Water temperature over 125°F (52°C) can cause severe burns instantly or death from scalds.
- Children, disabled, and elderly are at highest risk of being scalded.
- See instruction manual before setting temperature at water heater.
- Feel water before bathing or showering.
- Temperature limiting valves are available, see manual.

TIME/TEMPERATURE RELATIONSHIP IN SCALDS	
WATER TEMPERATURE	TIME TO PRODUCE A SERIOUS BURN
120°F (49°C)	More than 5 minutes
125°F (52°C)	1 ½ to 2 minutes
130°F (54°C)	About 30 seconds
135°F (57°C)	About 10 seconds
140°F (60°C)	Less than 5 seconds
145°F (63°C)	Less than 3 seconds
150°F (66°C)	About 1 ½ seconds
155°F (68°C)	About 1 second

Table courtesy of Shriners Burn Institute

WATER HEATER INSTALLATION GUIDELINES

WARNING

- This unit must be installed in accordance with local codes, if any; if not follow the National Fuel Gas Code, ANSI Z223.1/NFPA 54, or the Natural Gas and Propane Installation Code, CAN/CSA B149.1, as applicable.
- Failure to correctly install and operate this appliance can result in severe personal injury or death.
- The unit shall have a pressure relief valve installed within 6" [152mm] of the DHW HOT outlet connection.
Refer to the unit's User Manual before operating the relief valve.
- The unit requires a pressure relief valve identified with the ASME V or HV symbol and set to relieve at or below 150psi of domestic water pressure and a minimum relieving capacity of 199,000 Btu/hr with 3/4" NPT threads. For safe operation of the unit, the relief valve must not be removed from its designated point of installation or plugged.
- Read and follow warnings and instructions.

CAUTION

- Hotter water increases the risk of scald injury. Before changing the temperature setting, see instruction manual.

ADJUSTABLE TEMPERATURE SETTING

- Touch the panel above the white dot, then touch the Faucet . Adjust the water temperature with the Plus + and Minus - then touch the Return button to save the changes.

CONTROL OPERATION

NOTE

Use only fingers when operating the control.

The tankless water heater’s control functions as an interactive touch-sensitive panel with buttons that light up, showing indicators such as numbers, icons, or letters. Some of these lit indicators signify operational status, others enable programming the unit.

INTERFACE INDICATORS/BUTTONS

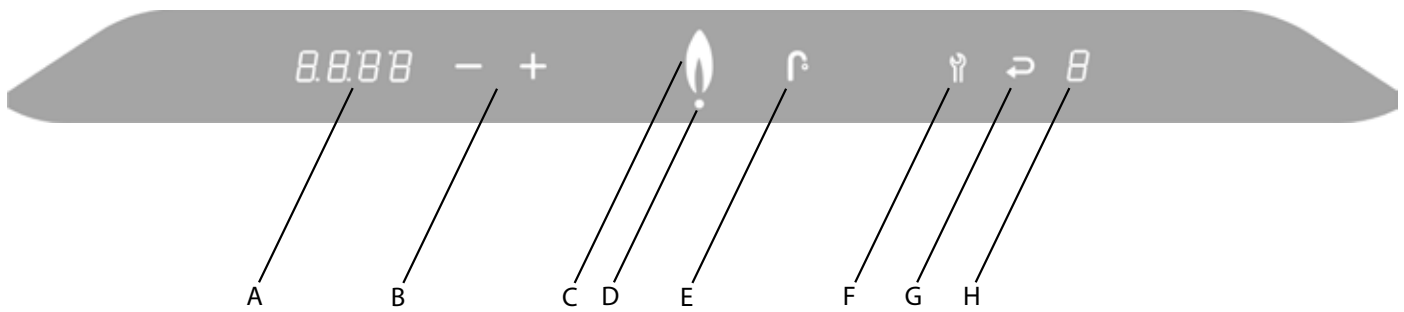

ICON		FUNCTION	
A	Numerical Display	Main Display	
B	Plus & Minus	Temperature Adjustment	
C	Flame	Burner ON Indicator	
D	Dot	Power ON Indicator	
E	Faucet	Domestic Hot Water Indicator	
F	Wrench	Service / Reset	
G	Return Arrow	Enter / Save	
H	Numerical Display	Service Display	

Table 1: Controller Indicators and Touch Pad

MAIN MENU

Main menu is a top-level menu, through which you can access other (sub) menus. These menus can be accessed by touching a button or a combination of buttons on the touchscreen panel. The sub menus include the:

- Domestic Hot Water (DHW) menu
Use to adjust the DHW temperature and Tankless DHW Mode.
- Information menu
Use to view sensor readings and other operating conditions.
- Service menu
Use to view service information and access the Installer menu to change parameters. In this menu, you can view service information and regulate the firing rate for the commissioning setup of the gas valve.

ACCESSING THE MAIN MENU

To access the Main menu, touch the area above the Dot.

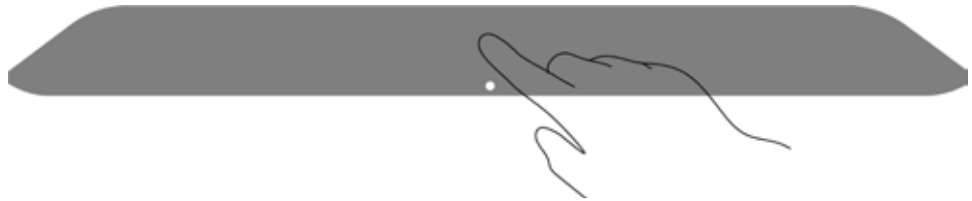

If buttons remain untouched in the Main menu (shown below) for a minute, the previous display is returned.



In the Main Menu the controller displays:

- The Dot.
- The Faucet button. Touch to access the DHW menu.
- The Wrench button. Touch to access the Service menu.
- The time, if the clock is activated.

OPERATIONAL MODES

Below are various operational modes:



The unit is connected to power but has been turned off. In this mode, the display view shows:

- The Dot.
- “OFF” is shown on the left display.
- A line in the right display.



The unit is turned on and is ready to respond to a request for domestic hot water or space heating. In this mode, the display view shows the Dot.



The unit is in operation and is supplying domestic hot water. In this mode, the display view shows the:

- Dot.
- Flame. The burner is switched on.
- Faucet symbol.

This page is intentionally left empty.

ADJUSTMENT MENUS

This section describes how to:

- Adjust the DHW water temperature
- Adjust the DHW modes
- Access the Service menu to test the unit firing rate
- Access the Information menu to obtain information on displayed codes

ADJUSTING THE DHW TEMPERATURE

To access the main menu:

1. Touch the area above the dot.
2. Touch the Faucet button.

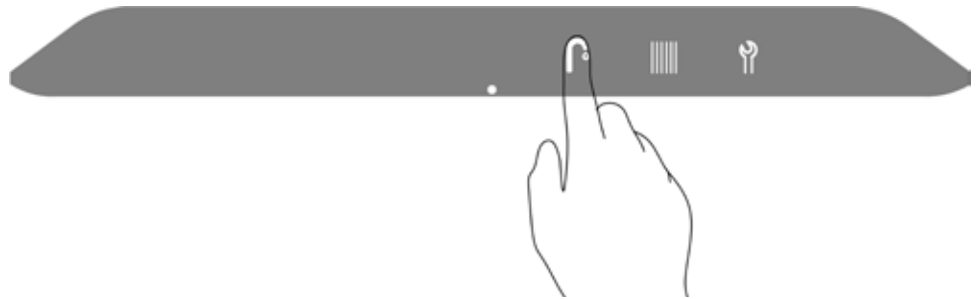

3. To change the DHW target temperature, touch the Plus or Minus buttons.



4.
 - To save the changes, touch the Return button.
 - To exit without saving the changes, touch the area above the dot.



“P” to the right of the screen indicates that the changes have been saved.



NOTE

The tankless water heater is equipped with a Freeze Protection feature. This feature will operate the burner to help protect the unit from freezing. We are not responsible for damages to the unit, and/or related components, nor property damages that may result from freezing conditions.

ADJUSTING THE DHW MODES

Standard Mode (OFF): The unit will only respond during a domestic hot water demand.

Comfort Mode (ON): The heat exchanger is always maintained at the DHW temperature.

ECO Comfort Mode (ECO): This mode operates like the Comfort Mode but has the added advantage of learning when the domestic hot water is used. During the low use periods, the heat exchanger is allowed to cool.

To switch between the 3 modes:

1. Touch the area above the dot.
2. Touch the Faucet button twice.

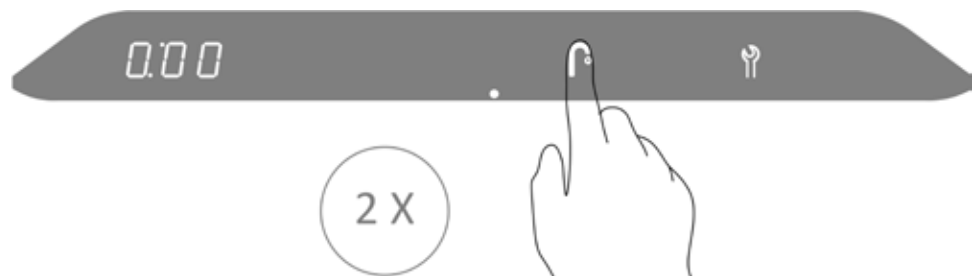

3. To change the DHW mode, touch the Plus or Minus buttons.

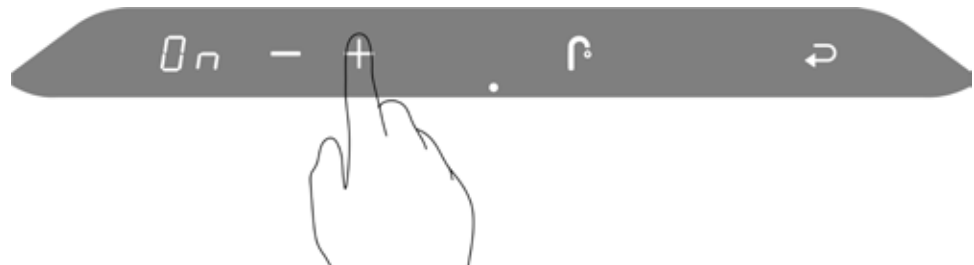

4.
 - To save the changes, touch the Return button.
 - To exit without saving the changes, touch the area above the dot.



“P” to the right of the screen indicates that the changes have been saved.



ACCESSING THE SERVICE MENU

The Service Menu provides service information and control over the unit firing rate, used in the commissioning setup of the gas valve.

To access the Service Menu, touch the area above the dot, then touch the wrench for two seconds until the return button appears.

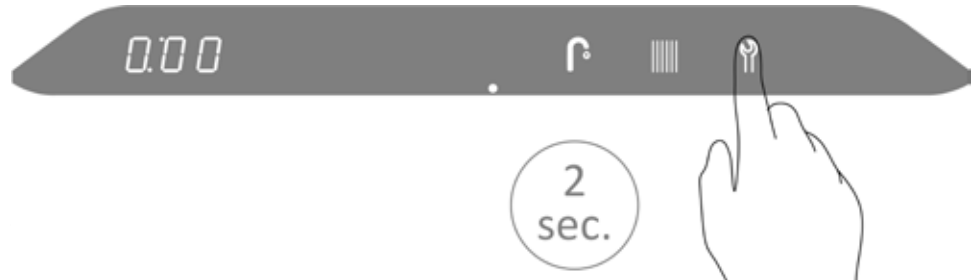

The Service menu is displayed below.



TESTING THE UNIT FIRING RATE

From the Service menu, you can test the unit's high-fire and low-fire operation.

Program 'L': Burner on at minimum DHW capacity. While running against a large load, touch Wrench and Minus at the same time. An 'L' will display on the right.

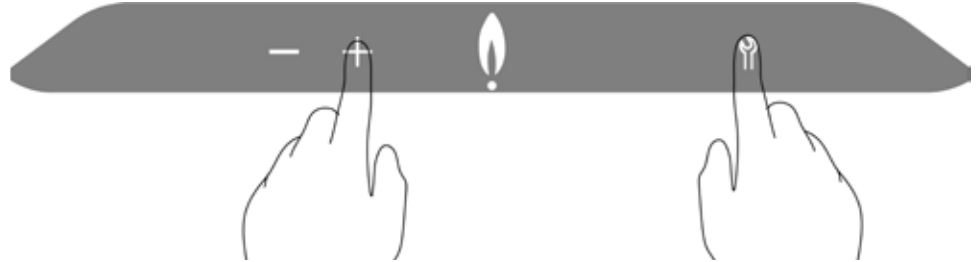

Program "H": Burner on at maximum DHW capacity. While running against a large load, touch Wrench and Plus simultaneously twice. An H will display on the right.

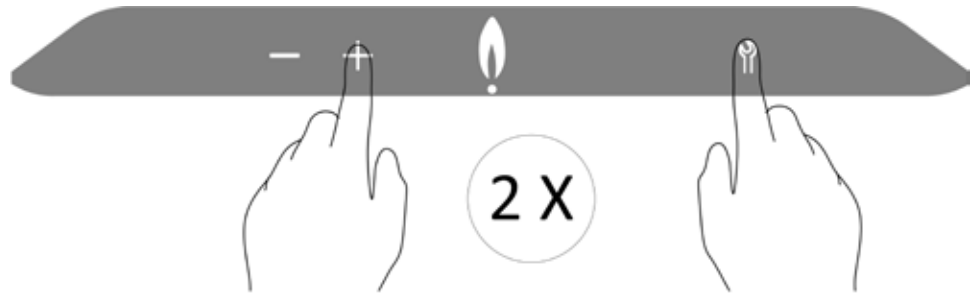

To switch off test program press the Plus and Minus at the same time.

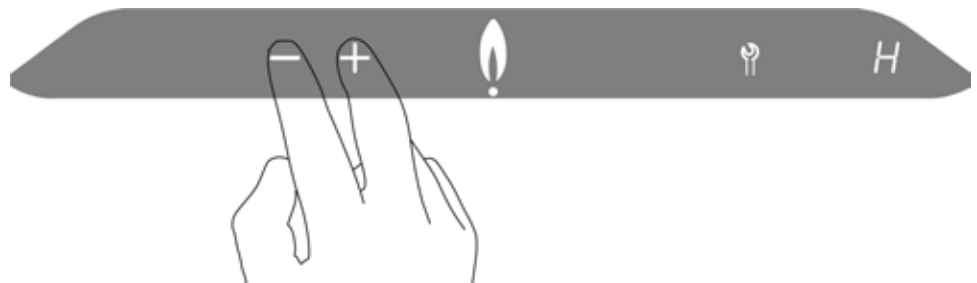

ACCESSING THE INFORMATION MENU

The Information menu provides real time operating information to assist with troubleshooting.

To access the Information menu:

1. Touch the area above the Dot.
2. Touch and hold the Wrench button for two seconds, let go when the minus, plus, and wrench are displayed.



3. Again, touch and hold the Wrench button for two seconds to enter the information menu.

See table 2 for a list of codes and corresponding description.

4. To scroll through the list of codes, use the Minus or Plus button.
5. To exit the Information menu and to return to the Service menu, press the area above the Dot.

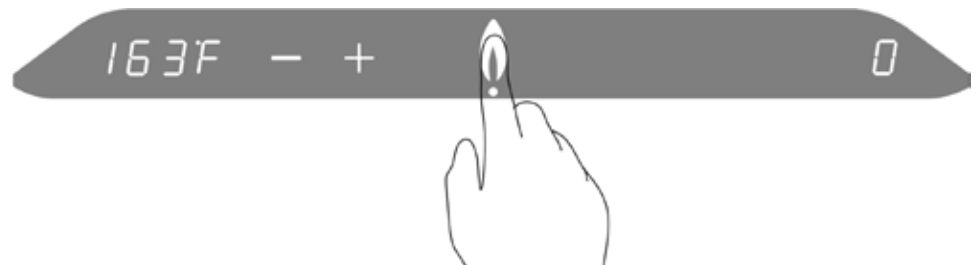

See below for a description of the codes:

CODE	DISPLAY	EXAMPLE
A	Flame current in μ A	9.80A
b	DHW flow in L/min or Gallon/min tankless/combi models only	8.0.98
C	Boiler system pressure boiler models only	8.18P
F	Estimated power input in kW or MBH	8.116
P	Actual pump speed in % boiler models only	88.42
t	Last lock-out code	F031
=	Main processor software	7.1.60
=	DSP software	7.1.20
0	Temp. S0 (Heat Exchanger)	81.34F
1	Temp. S1 (Boiler Supply)	81.18F
2	Temp. S2 (Not Applicable)	8.-.-F
3	Temp. S3 (Domestic Hot Water)	81.25F
4	Temp. S4 (Domestic Cold Water)	8.50F
5	Temp. S5 (Flue)	81.42F
6	Temp. S6 (Outdoor) - optional	8.17F
7	Temp. S7 (DHW tank) - optional	81.24F
P	Cascade Communication	8.4.42

Table 2: Information menu

ACCESSING PARAMETER MENUS TO CHANGE CONTROLLER PARAMETERS

The Parameter Menus allow users to change controller parameters set out in tables 3 and 4.

The most commonly used parameters will be available in the installer parameter menu, through the installer's access code 015. For more advanced users, an advanced parameter menu is available through access code 020.

The parameter menu access code is shown on the left numerical display after the letter C. The parameters are also shown on the left numerical display, after the letter P.

ACCESSING THE INSTALLER PARAMETER MENU

To access the Installer Parameter Menu:

1. Touch the area above the dot.

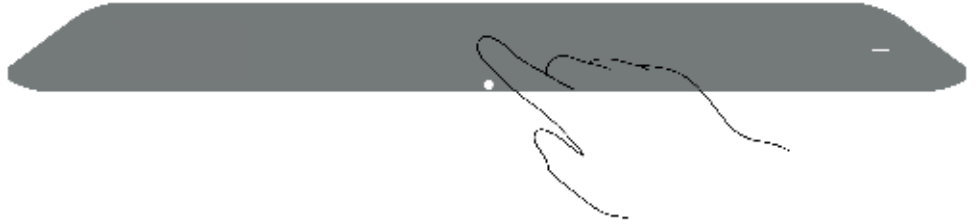

2. Touch the wrench for two seconds until the return button appears.



3. Touch wrench and return buttons together.



The code numbers are displayed in the left numerical display.



4. Change C000 to C015 by touching the + button.

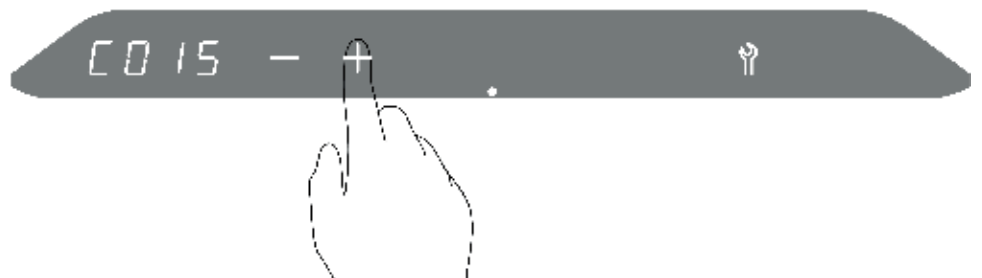

5. Touch wrench to enter the installer parameter menu.



6. Cycle through parameters using the – and + buttons.

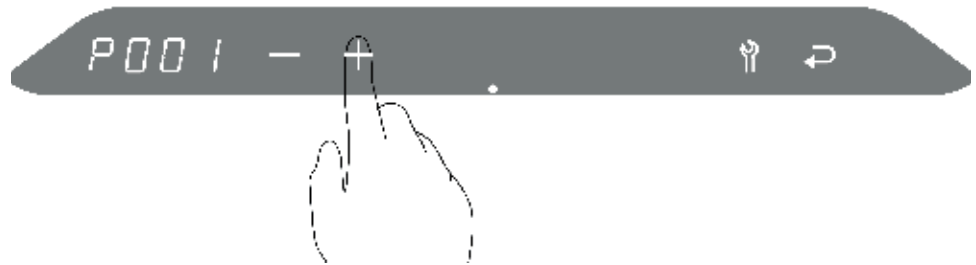

7. Touch the wrench to adjust the currently selected parameter.



8. Change parameter setting using the – and + buttons.

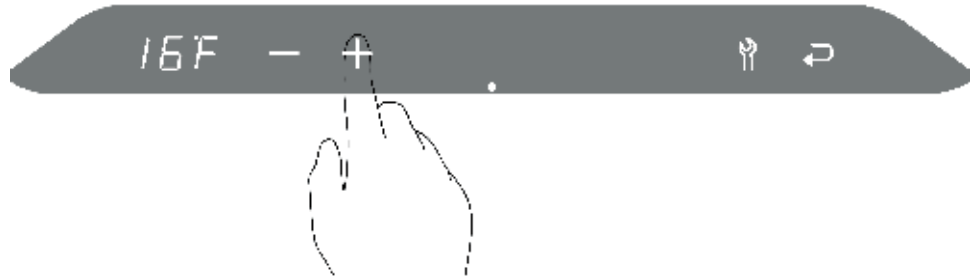

9. Press wrench to return to the installer parameters and make any additional changes.



10. After adjusting other parameters, press return to store installer parameter settings.

To exit the installer parameter menu without saving changes, touch the area above the Dot.



11. P will be briefly displayed on the right screen to indicate the changes have been stored.



INSTALLER PARAMETERS - ACCESS CODE C015

PARAMETER	DESCRIPTION	DEFAULT	RANGE / OPTIONS
P002	Display type	2	0 = Simple (Flame only) 1 = Basic (Flame and function) 2 = Complete (Flame, function, and current temperature setting)
P003	Units	1	0 = Metric (°C, L/S, Bar) 1 = Imperial (°F, gpm, PSI)
P087	DHW timer enable	1	0 = off 1 = on
P091	Function of Relay Re2, contact 3 on X3	5	0= Three-way valve (active during space heating) 1= Low temperature/ high temperature function active when heating demand is on a low temperature zone 2= Active during all heating demands 3= External heat source 4= Active during space heating demand for an external space heating pump 5= Active during DHW demand (solo) for an external DHW 6= Active during DHW demand (combi) for an external DHW
P094	Sampling time for DHW recirculation	0	0 - 90 minutes

Table 3: Installer parameter codes

ACCESSING THE ADVANCED PARAMETER MENU

To access the Advanced Parameter Menu:

1. Touch the area above the dot.

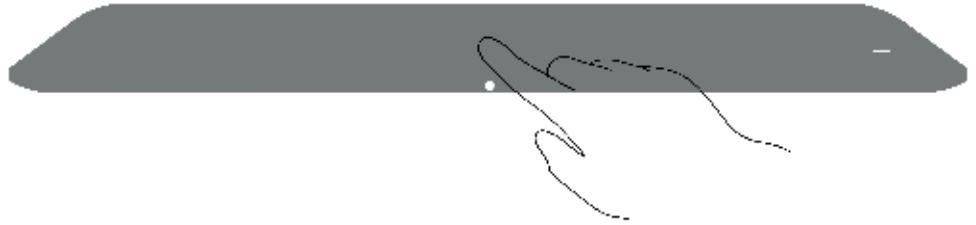

2. Touch the wrench for two seconds until the return button appears.



3. Touch wrench and return buttons together.



The code numbers are displayed in the left display.



4. Change C000 to C020 by touching the + button.

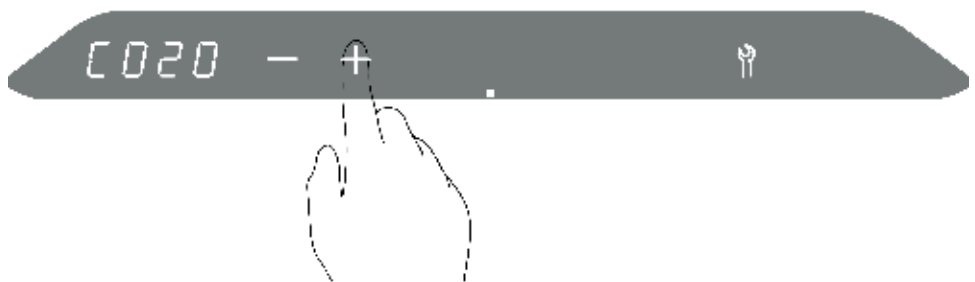

5. Touch wrench to enter the installer parameter menu.



6. Cycle through parameters using the – and + buttons.

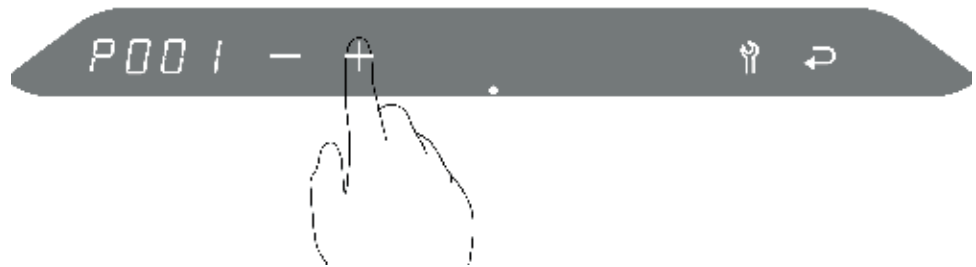

7. Touch the wrench to adjust the currently selected parameter.



8. Change parameter setting using the – and + buttons.

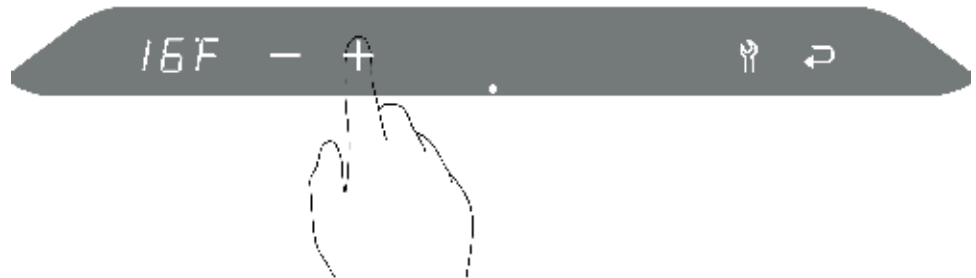

9. Press wrench to return to the installer parameters and make any additional changes.



10. After adjusting other parameters, press return to store installer parameter settings.

To exit the installer parameter menu without saving changes, touch the area above the Dot.



11. P will be briefly displayed on the right screen to indicate the changes have been stored.



ADVANCED PARAMETERS - ACCESS CODE C020

PARAMETER	DESCRIPTION	DEFAULT	RANGE / OPTIONS
P002	Display type	2	0 = Simple (Flame only) 1 = Basic (Flame and function) 2 = Complete (Flame, function, and current temperature setting)
P003	Units	1	0 = Metric (°C, L/S, Bar) 1 = Imperial (°F, gpm, PSI)
P009	Maximum output adjustment (%)	0%	-5% to 5%
P070	Maximum DHW capacity (%)	100%	20% to 100%
P071	Minimum DHW output (%)	15%	13% to 50%
P072	DHW ignition fan speed (%)	40%	40% to 100%
P073	DHW ECO / Comfort Mode temperature	32°F / 0°C	34°F / 1°C to 149°F / 65°C 0 = ECO / Comfort Mode will be the same as the user defined DHW temperature
P074	Number of ECO days	3 days	0 to 10 days Number of past days the predictive heat-exchanger heat-up algorithm averages over
P075	Supply Temperature for external indirect tank	171° F / 77°C	140°F to 194°F / 60°C to 90°C
P076	DHW Mode	0	0 = Standard Mode (on-demand) 1 = ECO Comfort Mode (adapts to DHW usage pattern) 2 = Comfort Mode (maintains DHW temperature)
P081	Setting of three-way valve or electric shutoff valve	0	0 = powered during Space Heating demand 1 = powered during DHW demand and no demand 2 = powered during Space Heating demand and no demand 3 = powered during DHW demand
P086	Temperature reduced during ECO Comfort mode low DHW demand periods	63°F / 17°C	32°F to 140°F / 0°C to 60°C
P087	DHW timer enable	1	0 = off 1 = on
P089	External tank set temperature unit	140°F / 60°C	50°F to 149°F / 10°C to 65°C

PARAMETER	DESCRIPTION	DEFAULT	RANGE / OPTIONS
P090	Function of Relay Re1, contact 3 on X4	5	<p>0= External valve (Functionality depends on P081 setting)</p> <p>1= Low temperature / high temperature function active when heating demand is on a low temperature zone</p> <p>2= Active during all heating demands</p> <p>3= External heat source</p> <p>4= Active during space heating demand for an external space heating pump</p> <p>5= Active during DHW demand (solo) for an external DHW pump</p> <p>6= Active during DHW demand (combi) for an external DHW</p> <p>7= DHW recirculation pump (SFT only), from software version 1v84</p>
P091	Function of Relay Re2, contact 3 on X3	5	<p>0= Three-way valve (active during space heating)</p> <p>1= Low temperature/ high temperature function active when heating demand is on a low temperature zone</p> <p>2= Active during all heating demands</p> <p>3= External heat source</p> <p>4= Active during space heating demand for an external space heating pump</p> <p>5= Active during DHW demand (solo) for an external DHW</p> <p>6= Active during DHW demand (combi) for an external DHW pump</p> <p>7= DHW recirculation pump (SFT only), from software version 1v84</p>
P094	Sampling time for DHW recirculation	0	0 - 90 minutes
P097	Alarm relay	0	<p>0= No alarm function</p> <p>1= Relay is activated when boiler is powered and not in lockout. Terminal X11 (X11.1= NC, X11.2= NO, X11.3=Com)</p>

PARAMETER	DESCRIPTION	DEFAULT	RANGE / OPTIONS
P100	Functionality of X13 terminals 3 and 4	0	0= Outdoor sensor 1= Low temperature zone safety sensor (Low temperature/high temperature) 2= WtW sensor, not applicable for North America 3= 10kΩ tank sensor, Aquastat (normally closed) 4 = 12 KΩ, supply temperature 5 = 12 KΩ, return temperature 6 = 10 KΩ, supply temperature 7 = 10 KΩ, return temperature
P101	Functionality of X13 terminals 4 and 5	0	0= 12kΩ tank sensor, Aquastat (normally opened) 1= Low temperature zone safety sensor (Low temperature/high temperature) 2= WtW sensor, not applicable for North America 3= 10kΩ tank sensor, Aquastat (normally closed) 4 = 12 KΩ, supply temperature 5 = 12 KΩ, return temperature 6 = 10 KΩ, supply temperature 7 = 10 KΩ, return temperature
P104	0-10V DC external control input	0	0= Off 1= 0-10V DC firing rate control 2= 0-10V DC temperature control
P130	Cascade Function	0	0 = Disabled 1 = Enabled for DHW 2 = Enabled for Space Heating 3 = Enabled for DHW & Space Heating
P131	Cascade Rotation Frequency	7	0 to 31 Days
P132	Cascade wear ethod	0	0 = Firing order based on hours of operation 1 = Firing order based on fuel consumption 2 = Firing order based on fuel consumption and number of ignitions
P133	Cascade Coarse Gain	35	0 - 250
P134	Cascade Fine Gain	25	0 - 250
P135	Cascade Space Heating Update Rate	30	30 - 250 Seconds
P136	Cascade DHW Staging Delay	10	5 - 250 Seconds
P137	Cascade Space Heating to DHW Delay	0	0 - 250 Seconds

PARAMETER	DESCRIPTION	DEFAULT	RANGE / OPTIONS
P138	Cascade Space Heating Drop Stage Level	30%	0 - 50 A stage will be disabled once the currently fired unit(s) reach this firing rate
P139	Cascade Space Heating Add Stage Level	90%	50 - 100 The next stage will be enabled once the currently fired unit(s) reach this firing rate
P255	Restore parameter to default	0	Set option to 9 to restore all parameters to factory default.

Table 4: Advanced parameter codes

ACCESSING THE CASCADE MENU

To access the Cascade Menu:

1. Touch the area above the dot.

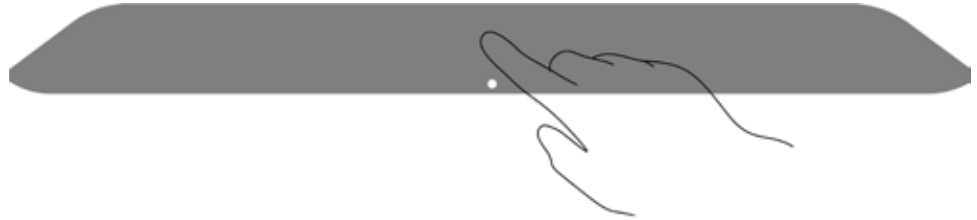

2. Touch the wrench for two seconds until the return button appears.

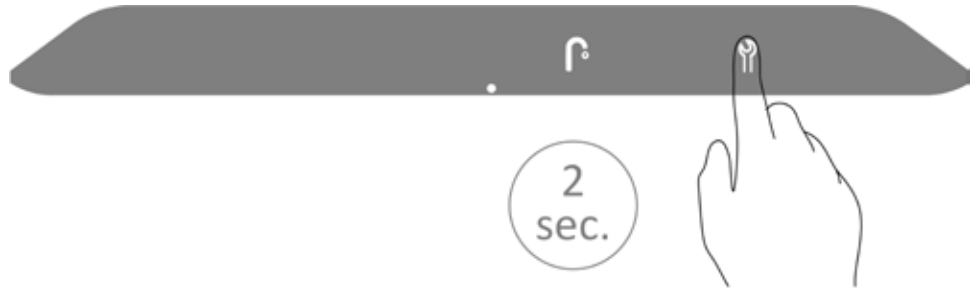

3. Touch wrench and return buttons together.



The code numbers are displayed in the left numerical display.



4. Change C000 to C035 by touching the + button.

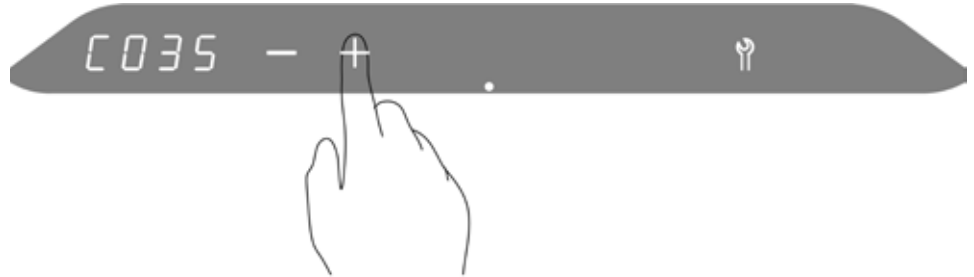

5. Touch wrench to enter the cascade menu.



6. Cycle through parameters using the – and + buttons.

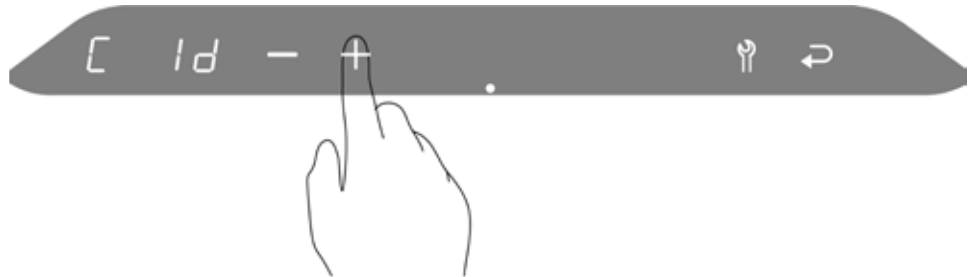

7. Touch the wrench to adjust the currently selected parameter.



8. Change parameter setting using the – and + buttons.

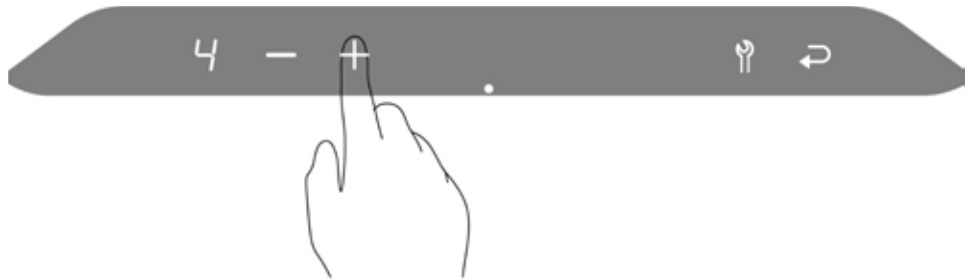

9. Press wrench to return to the cascade parameters and make any additional changes.



10. After adjusting other parameters, press return to store cascade parameter settings.



P will be briefly displayed on the right screen to indicate the changes have been stored.



CASCADE PARAMETERS - ACCESS CODE C035

PARAMETER	DESCRIPTION	DEFAULT	RANGE/OPTIONS
CId	Cascade Unit ID	1	1 - 8
CCA1	Cascade Systems ID	255	0 - 255
CCA2	Cascade Systems ID	255	0 - 255
CCA3	Cascade Systems ID	255	0 - 255
CCnt	Cascade Members	1	1 - 8

Table 5: Cascade parameters codes

CASCADE FUNCTION

The cascade function allows up to 8 Tankless Water Heaters or Combi Boilers to operate together to satisfy a common demand. The Leader of the cascade system will enable, disable, and modulate Followers as necessary to maintain temperature as efficiently as possible. Cascade system benefits include:

- Wireless communication for simplified setup
- Redundancy allows for easy service and maintenance of cascaded units
- Tankless Water Heaters and Combi Boilers can be cascaded together to simultaneously satisfy space heating and DHW demands

TANKLESS WATER HEATER CASCADE SYSTEM

Tankless Water Heater cascade systems are only able to satisfy domestic hot water demands. The Leader of the cascade system will enable, disable, and modulate Followers as necessary to provide domestic hot water. Reference Table 6 for required cascade settings.

Tankless Water Heater cascade systems should utilize an appropriately sized common header as shown in Figure 1. Reference Table 7 for minimum common domestic hot water header sizing.

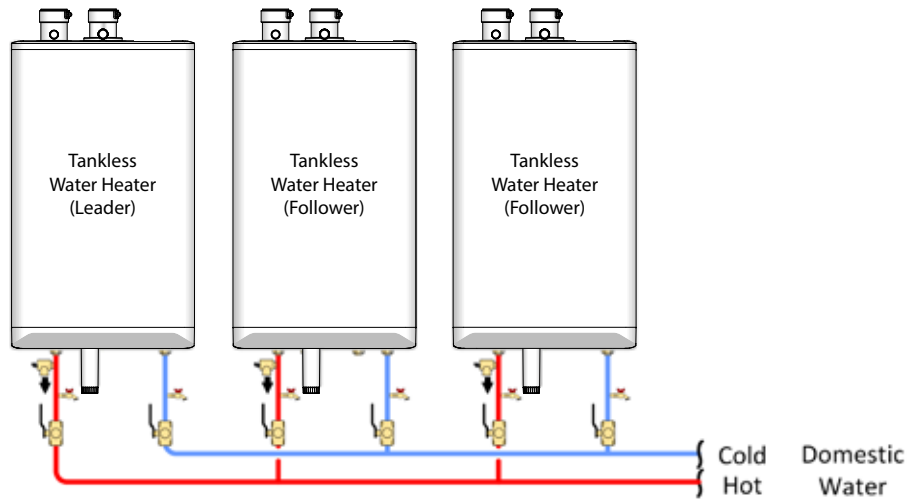

Figure 1: Typical Tankless Water Heater cascade piping – concept drawing. This drawing is only a simple schematic guide

PARAMETER	Leader (Tankless Water Heater)	Follower #1 (Tankless Water Heater)	Follower #2 (Tankless Water Heater)
Cascade Unit (C Id)	1	2	3
Cascade Members (Clrs)	3	-	-
Cascade Function (P130)	1	1	1

Table 6: Tankless Water Heater cascade parameter settings

Model	Minimum Recommended DHW Header Size						
	2 Units	3 Units	4 Units	5 Units	6 Units	7 Units	8 Units
199,000	1"	1¼"	1¼"	1½"	1½"	2"	2"

Table 7: Minimum Recommended DHW Header Size

TANKLESS WATER HEATER AND COMBI BOILER CASCADE SYSTEM

A cascade system of Tankless Water Heaters and Combi Boilers can be configured for applications with a greater domestic hot water load than space heating load. A Tankless Water Heater and Combi Boiler cascade system can simultaneously satisfy both domestic hot water and space heating demands. The Leader of the cascade system will enable, disable, and modulate Followers as necessary to provide domestic hot water. Any Combi Boilers not supplying domestic hot water can provide space heating. Reference Table 8 for required cascade settings.

Tankless Water Heater cascade systems should utilize an appropriately sized common header as shown in Figure 2. Reference Table 7 for minimum common domestic hot water header sizing.

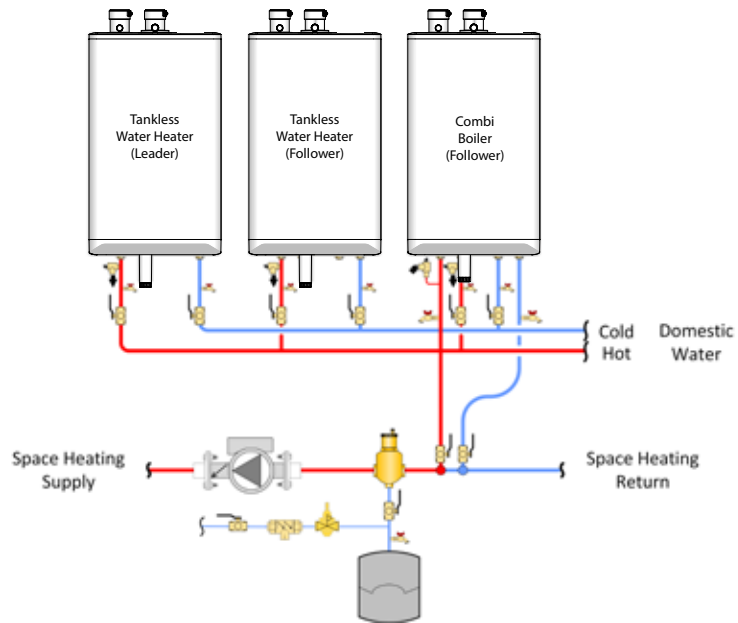

Figure 2: Typical Tankless Water Heater and Combi Boiler cascade piping – concept drawing. This drawing is only a simple schematic guide

PARAMETER	Leader (Tankless Water Heater)	Follower #1 (Tankless Water Heater)	Follower #2 (Combi Boiler)
Cascade Unit (C Id)	1	2	3
Cascade Members (Clrs)	3	-	-
Cascade Function (P130)	1	1	1

Table 8: Tankless Water Heater cascade parameter settings

LOW VOLTAGE WIRING

Tankless Water Heater cascade systems do not require low voltage wiring for domestic hot water operation. If a Combi Boiler is a member of the domestic hot water cascade system, low voltage wiring (Thermostat, Outdoor Sensor) should terminate at the Combi Boiler. A Combi Boiler in a domestic hot water cascade will respond to a locally wired space heating demand.

LINE VOLTAGE WIRING

Electrical wiring to the unit (including grounding) must conform to local electrical codes and/or National Electrical Code, ANSI/NFPA 70 – latest edition, or The Canadian Electrical Code, C22.1 – Part 1.

Connect each unit to the grid power using the supplied appliance plug to a fused circuit with on/off switch within sight of the unit.

CASCADE CONFIGURATION

Cascade system configuration requires setting the cascade parameters then enabling the cascade function on each unit that will be in the cascade system. Reference ACCESSING THE CASCADE MENU to make the following changes.

1. **Assign cascade unit ID (C Id)** – Each unit in the cascade system must be assigned a unique cascade unit ID. The cascade unit ID of the Leader must be set to 1. The cascade unit ID of each Follower must be set to 2, 3, etc.
2. **Assign cascade system ID (CCA1,CCA2,CCA3)** – Each cascade system must be assigned a unique cascade system ID. The cascade system ID only needs to be changed from the default setting when multiple cascade systems are present at the same location. The cascade system ID is broken up into 3 parameters, CCA1, CCA2, CCA3. The cascade system ID is CCA1 followed by CCA2 then CCA3. All units in the cascade system must be assigned the same cascade system ID number.
3. **Set number of cascade members (CCnt)** – This parameter must be set on the Leader to the number of cascade system members.

Reference ACCESSING THE ADVANCED PARAMETER MENU to make the following changes.

4. **Enable cascade function (P130)** – Enable the cascade function of each unit according to the cascade system type. The cascade function of Tankless Water Heaters can only be enabled for DHW (P130 = 1). The cascade function of Combi Boilers can be enabled for any combination of space heating / DHW (P130 = 1, 2, 3) depending on the application. A Combi Boiler will respond to any local demand not enabled for cascade, see Figure 2.
 - 1 = Enable cascade function for DHW
 - 2 = Enable cascade function for Space Heating
 - 3 = Enable cascade function for Space Heating and DHW

CASCADE COMMUNICATION

Wireless communication can be verified in each cascade member's Information Menu. Reference ACCESSING THE INFORMATION MENU to view information item "r":

- Information item "r" on the Leader will display X:YL
 - X = Number of members connected
 - Y = Number of configured members (CCnt)
 - L = Leader
- Information item "r" on a Follower will display:
 - C F = Follower is connected to the Leader
 - dC F = Follower is disconnected from the Leader

CASCADE ADJUSTMENTS

The following parameters can be used to adjust the cascade system operation after a cascade system has been configured. Reference ACCESSING THE ADVANCED PARAMETER MENU to make the following adjustments.

Rotation Frequency (P131) – Sets how often to rotate the lead stage during an extended call. If a call lasts longer than this setting, the next available stage will become the lead stage.

Firing Order (P132) – Sets the basis for calculating the firing order. The Leader will enable the unit with the least amount of usage when adding a stage. The Leader will disable the unit with the most amount of usage when disabling a stage. Usage calculation options are:

- 0 = Firing order is based on the hours of operation
- 1 = Firing order is based on fuel consumption
- 2 = Firing order is based on fuel consumption and number of ignitions

Coarse Gain (P133) – Increasing the Coarse Gain setting will cause the cascade system to ramp up faster when far below the setpoint. The cascade system will reach the setpoint quicker but is more prone to overshooting the setpoint. Decreasing the Coarse Gain setting will cause the cascade system to ramp up slower when far below the setpoint. The cascade system will take longer to reach the setpoint but is less likely to overshooting the setpoint.

Fine Gain (P134) - Increasing the Fine Gain setting will cause the cascade system to ramp up slower when near the setpoint. The cascade system may not be able to reach and maintain setpoint if the Fine Gain setting is too high. Decreasing the Fine Gain setting will cause the cascade system to ramp up faster when near the setpoint. The cascade system may oscillate above and below the setpoint if the Fine Gain setting is set too low.

DHW Staging Delay (P136) – When the Leader determines that another stage needs to be enabled to meet the DHW demand, this delay will occur before the stage is enabled.

RECIRCULATION FUNCTION

The recirculation function allows the tankless water heater to operate a field supplied domestic hot water recirculation pump to quickly provide hot water, saving time, energy, and water. The recirculation function automatically adapts to the site by only running the recirculation pump long enough to warm the entire recirculation loop. The frequency of recirculation pump operation is adjustable to accommodate any installation. The hours of operation are also adjustable, so that the recirculation pump only operates during typical periods of DHW usage to save energy.

RECIRCULATION PIPING

The recirculation pump must be installed between the farthest hot water fixture and the tankless water heaters cold water inlet as shown in Figure 3. If the recirculation pump does not contain a check valve, an external check valve must be added to the recirculation line.

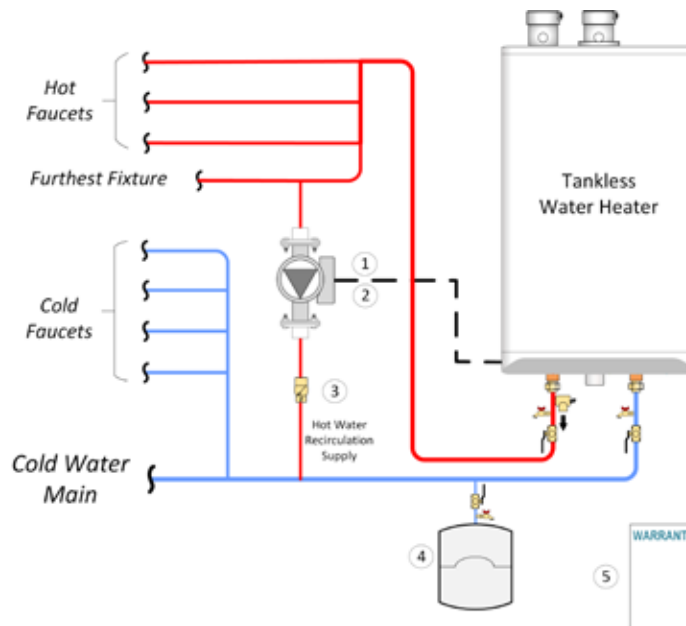

Notes

- ① The tankless water heater can operate the domestic hot water recirculation pump when wired to the X3 or X4 terminals. See the Tankless Water Heater Controller Manual for required parameter changes.
- ② The pump must be designed for use in potable water systems and have a flow rate greater than 0.5 gpm. The recirculation line and tankless water heater pressure drop must be taken into account when selecting a pump. Reference Graph 1 in the Tankless Water Heater Installation Manual for the tankless water heater pressure drop. Recommended pumps include Taco 006e3 and Grundfos UP 15-18 B5.
- ③ If the recirculation pump does not contain a check valve, an external check valve must be added to the recirculation line.
- ④ Potable Expansion Tank is required where backflow check valves are installed.
- ⑤ Domestic Hot Water Recirculation affects the terms of your Warranty. See Warranty document for details.

Figure 3: Typical DHW Recirculation piping – concept drawing. This drawing is only a simple schematic guide

LINE VOLTAGE WIRING

Electrical wiring to the unit (including grounding) must conform to local electrical codes and/or National Electrical Code, ANSI/NFPA 70 – latest edition, or The Canadian Electrical Code, C22.1 – Part 1.

Connect each unit to the grid power using the supplied appliance plug to a fused circuit with on/off switch within sight of the unit.

The recirculation pump should be wired to either the X3 (P091) or X4 (P090) terminals depending on which output has been configured for the recirculation function.

RECIRCULATION CONFIGURATION

Enable the recirculation function for either timer or 24 hour operation. Reference ACCESSING THE ADVANCED PARAMETER MENU to make the following changes.

1. Timer Operation (Recommended)

a. Enable DHW recirculation function (P090 / P091)

- i. Recirculation pump wired to X4 terminals – Set X4 Relay Function (P090) to 7.
- ii. Recirculation pump wired to X3 terminals – Set X3 Relay Function (P091) to 7.

b. Set DHW recirculation pump operation (P094) – Set the DHW recirculation pump operation frequency to the number of minutes between operation cycles. For example, setting DHW recirculation pump operation to 30 will result in the recirculation pump being enabled every 30 minutes or about twice per hour. Setting DHW recirculation pump operation to 0 results in constant operation during the selected hours of operation.

c. Enable DHW recirculation timer (P087) - The DHW recirculation timer must be set to 1 to enable operation only during designated times.

d. Set clock – Reference SETTING THE CLOCK to set the present time.

e. DHW recirculation operation times – Reference SETTING THE DHW RECIRCULATION TIMES to set the hours of recirculation operation.

2. 24 Hour Operation

a. Enable DHW recirculation function (P090 / P091)

- i. Recirculation pump wired to X4 terminals – Set X4 Relay Function (P090) to 7.
- ii. Recirculation pump wired to X3 terminals – Set X3 Relay Function (P091) to 7.

b. Set DHW recirculation pump operation (P094) – Set the DHW recirculation pump operation frequency to the number of minutes between operation cycles. For example, setting DHW recirculation pump operation to 30 will result in the recirculation pump being enabled every 30 minutes or about twice per hour. Setting DHW recirculation pump operation to 0 results in constant operation.

- c. **Enable DHW comfort code** - The DHW Comfort mode must be set to ON for 24 hour operation. Reference Tankless Domestic Hot Water Modes in the tankless water heater installation manual.

SETTING THE CLOCK

To set the clock:

1. Turn off the unit by touching the area above the dot for two seconds until a dash is displayed on the right. OFF will be displayed on the left after 5 seconds.

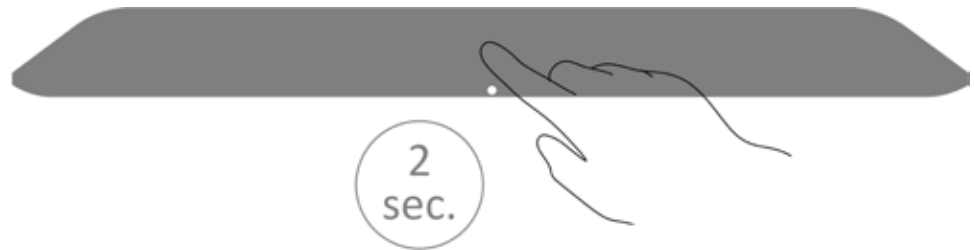

2. Touch the area above the dot.

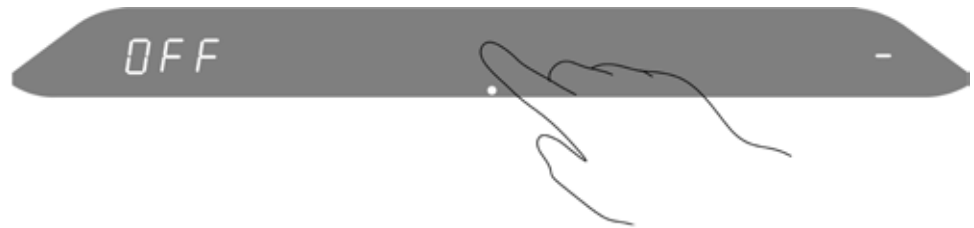

3. Set the time using the – and + buttons. Note that the clock is a 24 hour military type.

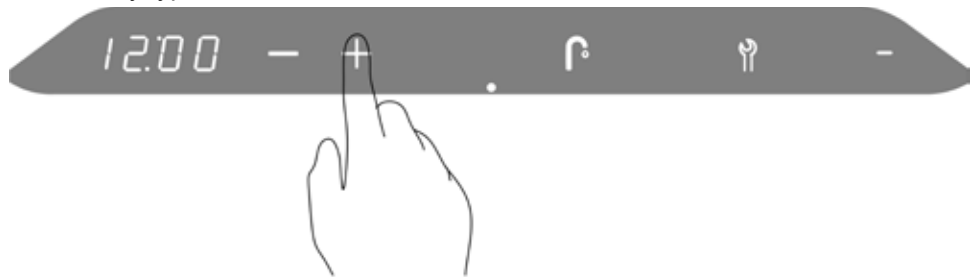

4. Touch return to enter the current time.



SETTING THE DHW RECIRCULATION TIMES

Up to four on / off recirculation times per day can be programmed so the recirculation pump only operates during typical periods of DHW usage. For example:

- t1 – 6:00 ON
- t2 – 9:00 OFF
- t3 – 17:00 ON
- t4 – 22:00 OFF

In this example, the recirculation function will be enabled between 6AM and 9AM then again between 5PM and 10PM.

To set an on /off time:

1. Touch the area above the dot.

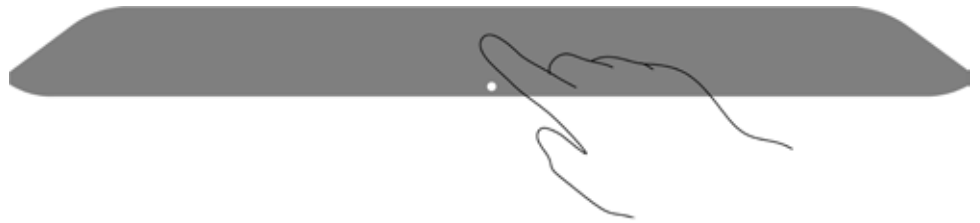

2. Touch the faucet button twice.

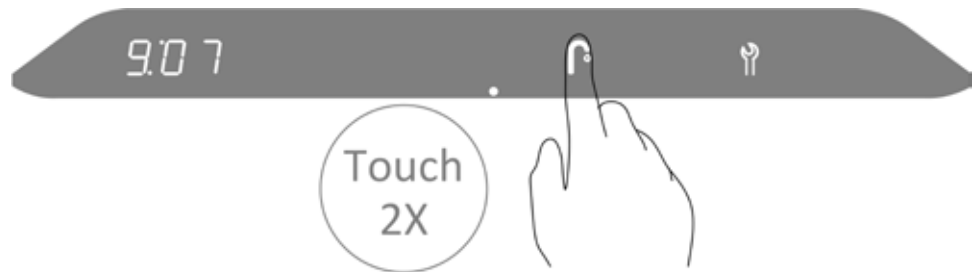

3. Touch the wrench button.



4. Touch the faucet button to select the first on /off recirculation time.

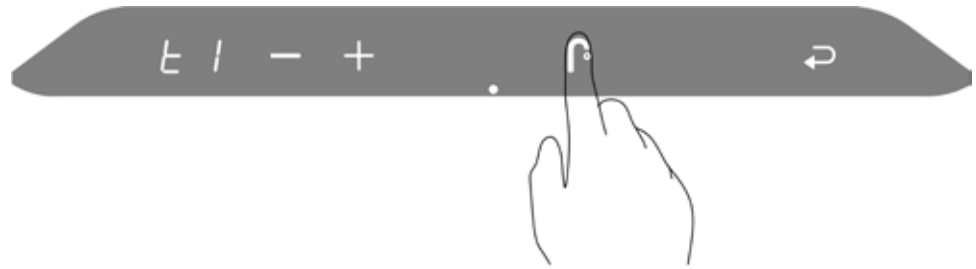

5. Change the first on / off recirculation time using the – and + buttons.

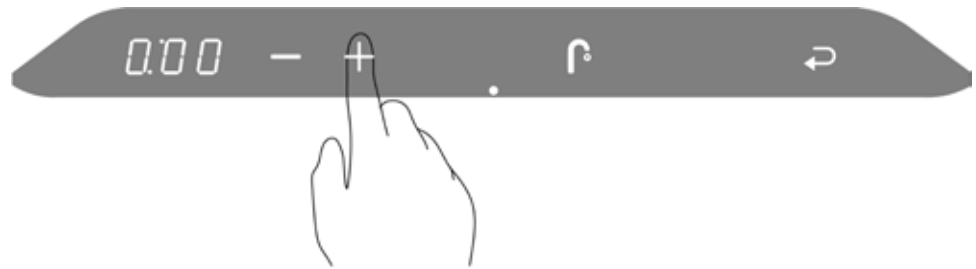

6. Touch the faucet button to select the desired action for the first on / off time:



7. Change the first on/off recirculation action using the – and + buttons.
- a. On = Recirculation function is enabled
 - b. Off = Recirculation function is disabled
 - c. - = No change, recirculation function remains in current state

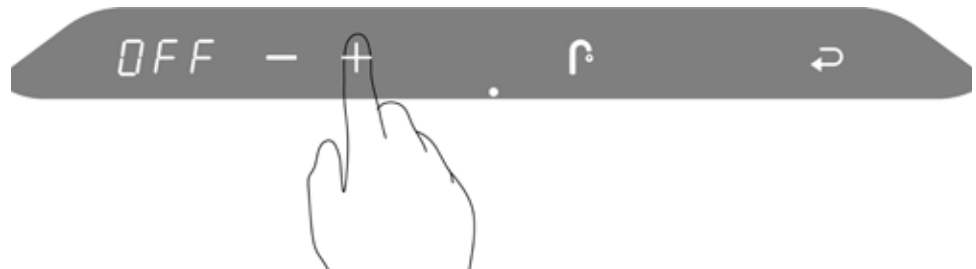

8. Touch the faucet button to return to t1.



9. Select the next recirculation time to program using the – and + buttons. Change the on / off recirculation time and action as outlined above.

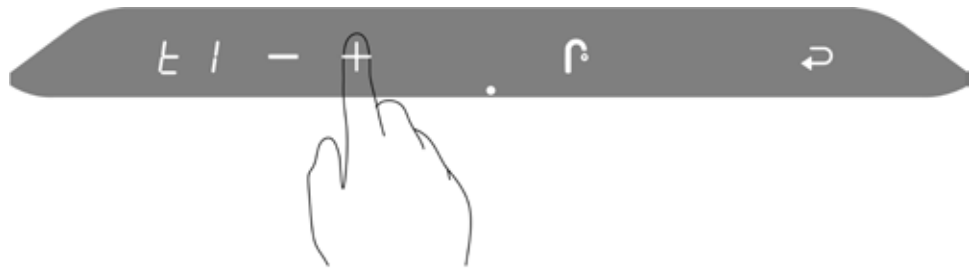

10. After adjusting all necessary on / off recirculation times, press return to store all settings.



P will be briefly displayed on the right screen to indicate the changes have been stored.



REMOVING & WIRING THE CONTROLLER



Figure 4: Junction box

The unit ships with an optional field-wiring junction box. This box provides wiring connections for a DHW recirculation pump, and an outlet for unit power. A certified harness from the wiring box connects to the movable controller tray.

The junction box is only required when the tankless water heater will be operating a field supplied domestic hot water recirculation pump.

REMOVING THE CONTROLLER

The figure below shows you how to pull out the controller.

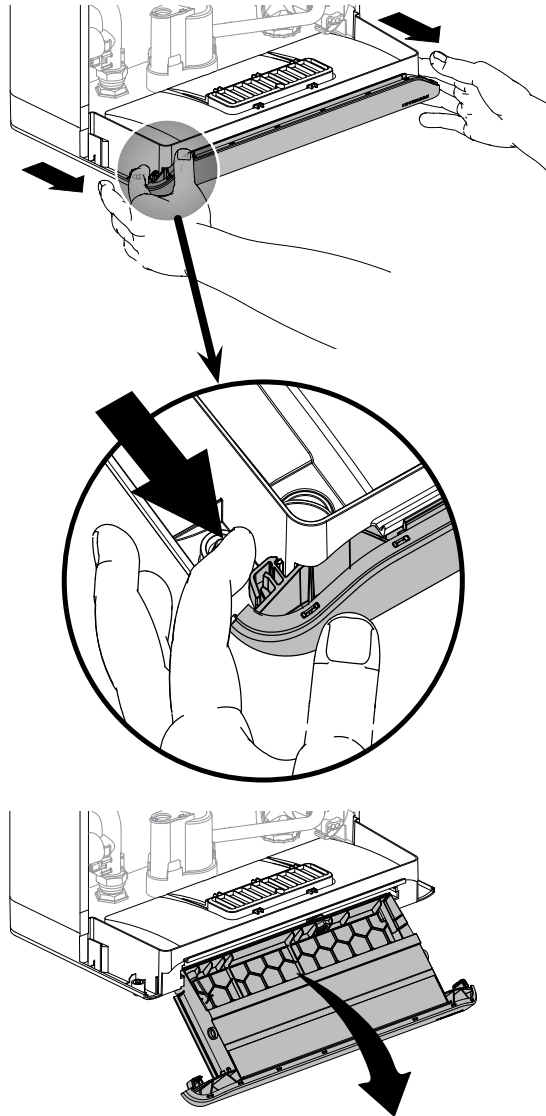

Figure 5: Pulling out the controller tray

WIRING THE CONTROLLER

Electrical wiring to the unit (including grounding) must conform to local electrical codes and/or National Electrical Code, ANS/NFPA No. 70 – latest edition, or The Canadian Electrical Code, C22.1 - Part 1.

If using an external electrical source, the unit, when installed, must be electrically bonded to ground in accordance with the requirements of the authority having jurisdiction or, in the absence of such requirements, with the *National Electrical Code, ANSI/NFPA 70, and/or the Canadian Electrical Code Part I, CSA C22.1, Electrical Code.*

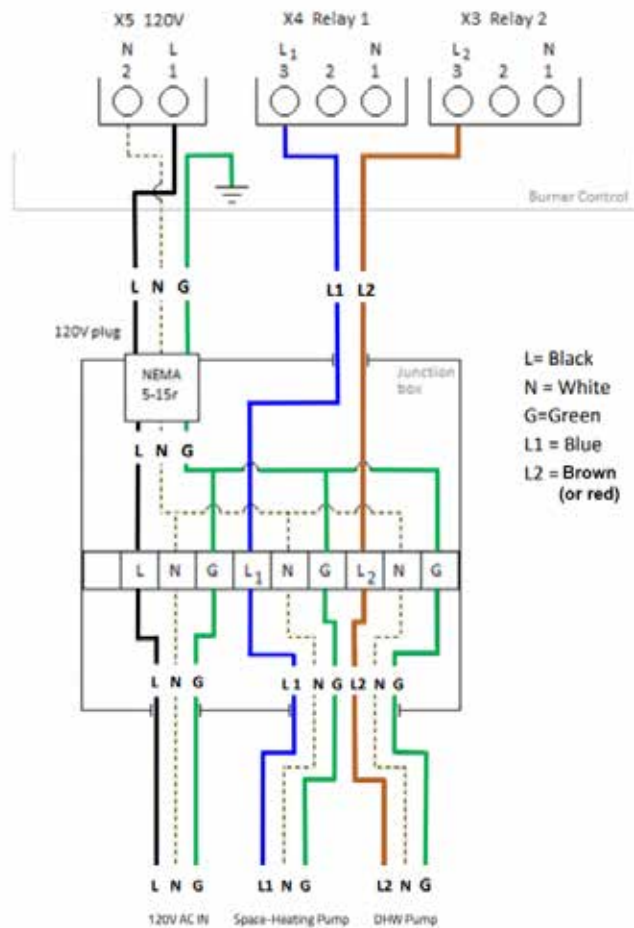

Figure 6: Junction box schematic



120VAC LINE VOLTAGE HOOK-UP

Connect the unit to the grid power, using the supplied appliance plug in a separate, fused circuit and on/off switch within sight of the unit.

SEQUENCE OF OPERATION

When the unit is powered up the controller enters a self-diagnostic mode, and displays the controller software version in the main display.

The sequence of operation is as follows:

1. The unit receives a call for domestic hot water heating from the internal flow sensor.
2. The unit performs a safety check and energizes the fan for a pre-purge (*Service Display = 3*).
3. Once the 5-second pre-purge is complete, the unit enters a 5-second trial for ignition (*Service Display = 4*). If the unit fails to ignite, the unit will complete another 5-second pre-purge then 5-second trial for ignition. This is repeated 4 times before a hard lock-out occurs. The Return button  must be pressed to reset the controller and begin another trial for ignition.
4. Once the burner is lit and flame has been proven the unit operates as it is programmed (*Display =  + * for domestic hot water).
5. If the unit exceeds its target temperature and there is still a call for hot water the burner will turn off. (*Service Display = 1*)
6. If the burner is on to maintain the heat exchanger temperature for DHW Comfort mode (*Service Display = 7*).
7. If the burner is on for frost protection (*Service Display = 9*).



MAIN DISPLAY	SERVICE DISPLAY	DESCRIPTION
OFF	-	The unit is OFF. Press the space above the dot for 2 seconds to turn on the unit.
(blank)	(blank)	No Call for Hot Water - Standby
XXX	1	Unit water temperature exceeds target, call still present
XXX	2	Self-test – When power is applied to the unit the controller enters a self diagnostic mode for 5 seconds
XXX	3	Fan Pre-purge and Post-purge
XXX	4	Trial for Ignition and Flame Proving
XXX	 + 	Heating – DHW
XXX	7	Burner on for DHW Comfort mode
XXX	9	Freeze Protection mode

Table 9: Operating Display and Service Display Codes.

TEMPERATURE SENSORS

The resistance of the temperature sensors varies inversely with temperature. To test, measure the temperature of the sensed environment and compare with the value derived from the measurement of the resistance (obtained by connecting a good quality test meter capable of measuring up to 5,000 K Ω (5,000,000 Ω) at the controller end of the sensor lead).

To obtain a resistance reading, remove power to the unit. For the water temperature sensors, remove the wire leads by disconnecting their respective Molex connectors. Place multi-meter probes into the sensor's male Molex connector socket. Do not apply voltage to the sensor as damage may result.

12K Ω temperature sensors are supplied with the unit. See Table 11 for resistance values.

SENSOR	TYPE	PURPOSE	LOCATION
S0	NTC 12K Ω	Heat Exchanger Temperature	Left side of Heat Exchanger
S3	NTC 12K Ω	Domestic Hot Water	DHW Supply Pipe
S4	NTC 12K Ω	Domestic Cold Water	DCW Supply Pipe
S5	NTC 12K Ω	Flue Gas Temperature	Top of rear Flue passage
PTC1 PTC2	PTC	Cabinet Temperature	Left and right Side top of inner cabinet

Table 10: Temperature Sensors

TEMPERATURE	RESISTANCE	TEMPERATURE	RESISTANCE	TEMPERATURE	RESISTANCE
F / C	Ω - ohm	F / C	Ω - ohm	F / C	Ω - ohm
5F / -15C	76,020	77F / 25C	12,000	149F / 65C	2,752
14F / -10C	58,880	86F / 30C	9,805	158F / 70C	2,337
23F / -5C	45,950	95F / 35C	8,055	167F / 75C	1,994
32F / 0C	36,130	104F / 40C	6,653	176F / 80C	1,707
41F / 5C	28,600	113F / 45C	5,522	185F / 85C	1,467
50F / 10C	22,800	122F / 50C	4,609	194F / 90C	1,266
59F / 15C	18,300	131F / 55C	3,863	203F / 95C	1,096
68F / 20C	14,770	140F / 60C	3,253	212F / 100C	952

Table 11: Temperature Sensor Resistance Values – 12K Ω sensors.

TROUBLESHOOTING

FAULT CODES

During operation the controller can detect unusual situations and can take action to avoid damage to the heat exchanger or other unsafe operations. During these situations, the controller limits the temperature and power output of the burner, or temporarily disables operation entirely.

These faults are shown flashing and visible on the main display, and display only when an unusual reading is currently detected. Fault Codes can be reset by touching the wrench for 2 seconds after the cause of the fault has been resolved.

FAULT CODE	DESCRIPTION	POSSIBLE CAUSE / SOLUTION
F000	Heat exchanger temperature sensor fault.	<ul style="list-style-type: none"> • Verify wire harness connections at heat exchanger temperature sensor and control module are tight. • Replace heat exchanger temperature sensor.
F002	High heat exchanger temperature during DHW demand.	<ul style="list-style-type: none"> • Verify the unit has been converted to propane if operating on propane • Verify combustion readings at low and high fire are within specifications. • Clean heat exchanger DHW coil. • Clean fire side of heat exchanger.
F003	High flue temperature.	<ul style="list-style-type: none"> • Verify the unit has been converted to propane if operating on propane. • Verify combustion readings at low and high fire are within specifications. • Clean fire side of heat exchanger. • Clean heat exchanger central heating and DHW coils.
F004	No flame detected during four ignition trials.	<ul style="list-style-type: none"> • Verify external gas shutoff valve is open. • Verify gas inlet pressure is at least 4" during ignition trial. • Verify condensate drain is not blocked. • Check vent and combustion air piping for blockage. • Verify internal and power supply grounding. • Verify ground spring is in contact with burner head screw. • Verify ignitor to ignition module connection is tight. • Check ignitor condition and clean/replace as necessary. • Verify operation of the backflow flapper in the fan outlet. • Verify ignitor is not in contact with burner and gap is correct. • Replace ignition module if unit lights but flame icon doesn't illuminate. • Replace ignition module if spark is not present and 110VAC is present on ignition module black and gray wires. • Replace control module if spark is not present and 110VAC is not present on ignition module black and gray wires. • Replace gas valve if gas inlet pressure does not drop during trial for ignition and 24VDC is present at gas valve harness. • Replace control module if gas inlet pressure does not drop during trial for ignition and 24 VDC is not present at gas valve harness.

FAULT CODE	DESCRIPTION	POSSIBLE CAUSE / SOLUTION
F005	No flame detected during operation.	<ul style="list-style-type: none"> • Verify condensate drain is not blocked. • Check vent and combustion air piping for blockage. • Check for flue gas recirculation. • If vent termination is subject to high winds, reconfigure/relocate as necessary. • Verify gas inlet pressure is at least 4" at both low and high fire. • Verify low and high fire combustion readings are within specifications. • Check ignitor condition and clean/replace as necessary.
F006	Flame detected when burner is off.	<ul style="list-style-type: none"> • Verify good internal and power supply grounding. • Verify flame goes out at conclusion of demand, if not replace gas valve. • Replace ignition module. • Replace control module.
F007	Low flame signal.	<ul style="list-style-type: none"> • Verify ignitor to ignition module connection is tight. • Check ignitor condition and clean/replace as necessary. • Verify low and high fire combustion readings are within specifications.
F008	Incorrect fan speed	<ul style="list-style-type: none"> • Verify wire harness connections at fan and control module are tight. • Replace fan. • Replace control module.
F009	Control module internal fault.	<ul style="list-style-type: none"> • Remove all field wiring from unit then reset fault. • Check field wiring for voltage backfeed if F009 fault does not return. • Replace control module if F009 fault code returns.
F010	Heat exchanger temperature sensor open.	<ul style="list-style-type: none"> • Verify wire harness connections at heat exchanger temperature sensor and control module are tight. • Check resistance of each heat exchanger temperature sensor (center pin is common), replace sensor if open circuit is found. • Check resistance of each heat exchanger temperature sensor (center pin is common) at control module harness connector, repair wire harness if open circuit is found.
F012	Flue temperature sensor open.	<ul style="list-style-type: none"> • Verify wire harness connections at flue temperature sensor and control module are tight. • Check resistance of flue temperature sensor, replace sensor if open circuit is found. • Check resistance of flue temperature sensor at control module harness connector, repair wire harness if open circuit is found.
F013	DHW inlet temperature sensor open/short	<ul style="list-style-type: none"> • Verify wire harness connections at DHW inlet temperature sensor and control module are tight. • Check resistance of DHW inlet temperature sensor, replace sensor if open/short circuit is found • Check resistance of DHW inlet temperature sensor at control module harness connector, repair wire harness if open/short circuit is found
F014	Heat exchanger temperature sensor mounting fault.	<ul style="list-style-type: none"> • Heat exchanger temperature is not changing while unit is fired. • Verify heat exchanger temperature sensor is properly mounted on the heat exchanger.
F015	High cabinet temperature	<ul style="list-style-type: none"> • Check heat exchanger for flue gas leakage • Check vent pipe for flue gas leakage
F016	DHW outlet temperature sensor mounting fault	<ul style="list-style-type: none"> • DHW outlet temperature is not changing while unit is fired • Verify DHW outlet temperature sensor is properly mounted on the DHW outlet pipe

FAULT CODE	DESCRIPTION	POSSIBLE CAUSE / SOLUTION
F017	DHW bypass valve fault	<ul style="list-style-type: none"> • Verify wire harness connections at DHW bypass valve and control module are tight • Check resistance of DHW bypass valve at control module harness connector: Green - Purple = 30 to 40 Ω Green - Blue = 30 to 40 Ω Green - Yellow = 30 to 40 Ω Green - Orange = 30 to 40 Ω Red - Black = 5.5 to 6.5 MΩ Red - Brown = 17 to 21 MΩ • If any resistance value is outside of these ranges, check and repair any wire harness open/short circuit before replacing DHW bypass valve
F018	Flue/Combustion Air blockage.	<ul style="list-style-type: none"> • Check the vent and combustion air pipes for blockage. • Verify operation of the backflow flapper in the fan outlet.
F019	Boiler Memory Module (BMM) fault.	<ul style="list-style-type: none"> • Verify wire harness connections at boiler memory module and control module are tight. • Verify wire harness continuity between boiler memory module and control module . • Replace boiler memory module.
F021	Critical parameter changed	<ul style="list-style-type: none"> • Factory reset required
F028	Reset button fault	<ul style="list-style-type: none"> • Check the reset button for unintentional operation (e.g. cleaning of the control panel). • Replace the control module.
F029	Gas valve fault.	<ul style="list-style-type: none"> • Verify wire harness connections at gas valve and control module are tight • Replace gas valve if upper coil resistance is not 35 to 45 Ω. • Replace gas valve if lower coil resistance is not 20 to 30 Ω. • Check resistance of gas valve at control module harness connector, repair wire harness if open/short circuit is found or if resistance is not within 60 to 70 Ω • Replace control module.
F040	Cabinet temperature sensor open.	<ul style="list-style-type: none"> • Verify wire harness connections at cabinet temperature sensors and control module are tight. • Check resistance of cabinet temperature sensors, replace sensor if open circuit is found. • Check resistance of cabinet temperature sensors at control module harness connector, repair wire harness if open circuit is found.
F041	Cabinet temperature sensor short	<ul style="list-style-type: none"> • Check resistance of cabinet temperature sensors, replace sensor if short circuit is found. • Check resistance of cabinet temperature sensors at control module harness connector, repair wire harness if short circuit is found.
F042	Cascade DHW not available	<ul style="list-style-type: none"> • Resolve any other lockouts in the cascade system • Verify Leader cascade parameter settings are correct • Verify Follower(s) cascade parameter settings are correct • Check cascade communication status in the information menu of both Leader and Follower

FAULT CODE	DESCRIPTION	POSSIBLE CAUSE / SOLUTION
-- (Blinking)	Water pressure sensor fault	<ul style="list-style-type: none"> • Verify wire harness connections at water pressure sensor and control module are tight • Check resistance of water pressure sensor at control module harness connector: Black - Orange = 7.5 to 9.5 KΩ Black - Yellow = 7.5 to 9.5 KΩ • If any resistance value is outside of these ranges, check and repair wire harness open/short circuit before replacing water pressure sensor

Table 12: Fault codes

NOTIFICATION CODES

During operation the controller can also detect unusual situations and display a notification, usually without significant interruption of the normal operation of the appliance.

These warnings are shown flashing and visible on the main display, and display only when an unusual reading is currently detected. Once the error has been resolved, the operation will be restored

Note that these notifications only appear on controllers installed with software versions after 1.80. The software version of the controller will appear upon the controller's initial start up.

NOTIFICATION CODE	DESCRIPTION	POSSIBLE CAUSE / SOLUTION
n030	DHW outlet temperature sensor open/short	<ul style="list-style-type: none"> • Verify wire harness connections at DHW outlet temperature sensor and control module are tight. • Check resistance of DHW outlet temperature sensor, replace sensor if open/short circuit is found. • Check resistance of DHW outlet temperature sensor at control module harness connector, repair wire harness if open/short circuit is found.
n040	Cascade communication lost	<ul style="list-style-type: none"> • Verify Leader is powered on and cascade parameter settings are correct. • Verify Follower(s) cascade parameter settings are correct. • Check cascade communication status in the information menu of both Leader and Follower.
n041	Cascade system sensor open	<ul style="list-style-type: none"> • Verify system sensor field wiring is terminated at the chosen input (X13-3&4 or X13-4&5). • Check resistance of system temperature sensor, replace sensor if open circuit is found. • Check resistance of system temperature sensor at control module harness connector, repair system sensor field wiring if open circuit is found.
n120	Maintenance recommended	<ul style="list-style-type: none"> • Maintenance is recommended based on hours of use.
n121	Maintenance required, limited DHW output	<ul style="list-style-type: none"> • Maintenance is required based on hours of use. • DHW output will be limited until maintenance is performed.
n122	Maintenance required, no DHW output	<ul style="list-style-type: none"> • Maintenance is required based on hours of use. • DHW output is disabled until maintenance is performed.
n150	High heat exchanger temperature, limited output	<ul style="list-style-type: none"> • Verify all air has been bled/purged from the heat exchanger central heating coil. • Replace internal pump if it is not operating during a central heating demand. • Verify the unit has been converted to propane if operating on propane. • Verify combustion readings at low and high fire are within specifications. • Clean fire side of heat exchanger. • Clean heat exchanger central heating and DHW coils.

NOTIFICATION CODE	DESCRIPTION	POSSIBLE CAUSE / SOLUTION
n151	High flue temperature, limited output	<ul style="list-style-type: none"> • Verify the unit has been converted to propane if operating on propane. • Verify combustion readings at low and high fire are within specifications. • Clean fire side of heat exchanger. • Clean heat exchanger central heating and DHW coils.
n152	Flue temperature sensor mounting fault	<ul style="list-style-type: none"> • Flue temperature is not changing while unit is fired. • Verify flue temperature sensor is properly mounted on the vent pipe.
n201	Heat exchanger air purge function activated	<ul style="list-style-type: none"> • Air trapped in the heat exchanger • Closed boiler isolation valve • Defective boiler pump
n202	High flue temperature, burner disabled	<ul style="list-style-type: none"> • Verify the unit has been converted to propane if operating on propane. • Verify combustion readings at low and high fire are within specifications. • Clean fire side of heat exchanger • Clean heat exchanger central heating and DHW coils.
n245	Flue gas back flow, fan on low speed	<ul style="list-style-type: none"> • Verify vent and combustion air piping and terminations are installed according to this manual. • Verify operation of the backflow flapper in the fan outlet.

Table 13: Notification codes

This page is intentionally left empty.

This page is intentionally left empty.

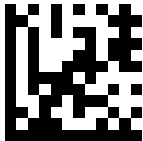

84162404

Rheem Sales Co.

Montgomery, AL.

(833) 212-9276

IBC Technologies Inc.

8015 North Fraser Way

Burnaby, BC Canada V5J 5M8

(844) HEAT-IBC / (844) 432-8422

IBC Technologies USA Inc.

121 Walter A Gaines Way

Lawnside, NJ 08045

(856) 887-0544

May 2023 ©