



TRITON™

80, 100 & 119 GALLON ULTRA-HIGH EFFICIENCY WATER HEATERS



For use with the following models:

GHE80SS, GHE80SU, GHE100SS,
GHE100SU, GHE119SS, GHE119SU

CATEGORY IV Models

Fan Assisted Combustion

SERVICE & TRAINING MANUAL

AP23084 Rev 01

CONTENTS

INTRODUCTION	4
SAFETY	4
SPECIFICATIONS OF THE TRITON	5
SPEED TABLE.....	6
COMPONENT PARTS	7
WIRING AND SCHEMATIC DIAGRAM	9
TOP VIEW	11
PARTS.....	13
NAVIGATING THE HOME SCREEN	16
USER INTERFACE	17
DISPLAY MESSAGES ON CONTROL BOARD.....	20
SEQUENCE OF EVENTS	21
SEQUENCE OF OPERATIONS.....	24
SAFETY FUNCTIONS OF THE CONTROLS	28
ERROR CODES.....	30
TROUBLE SHOOTING ERROR CODES	33
GAS PRESSURE CHECKING PROCEDURES	49
TRITON DISASSEMBLY AND REPAIR (VIDEO LINKS).....	53
DISASSEMBLY AND REPAIR.....	54
BACNET CONFIGURATIONS	60
LEAK GUARD™	64

⚠ WARNING

Before inspecting, diagnosing, repairing or operating any water heater, be sure to examine all of the safety and warning labels on the tank. Follow the instruction on these warning labels. Read and understand the Use and Care Manual that was shipped with the water heater. Failure to do so can result in unsafe operation of the water heater resulting in property damage, bodily injury, or death. Should you have any problems reading or following the instructions in the Use and Care Manual, seek the help of a licensed and qualified professional.

**TECHNICAL SUPPORT LINE**

PHONE: 800-432-8373

FAX: 334-260-1341

ORDER CENTER

1-800-621-5622

RHEEM WATER HEATERS800 Interstate Park Dr.
Montgomery, AL 36109Website: www.rheem.comEmail: Techserv@Rheem.com

INTRODUCTION

The control system for the fully condensing 80, 100, and 119 gallon Gas High Efficiency (GHE) Commercial Gas Water Heater is intended for use indoors. The control combines all operational functions needed for a water heater with a powered burner system into a single printed circuit board package. The control inputs are from a water temperature probe, pressure switches, flue gas temperature sensor, high temperature limit switch and flame sensor. The control provides outputs for a blower motor, spark igniter, gas valve, and has a nonvolatile storage of fault history. The system incorporates a liquid crystal display (LCD) as the interface for the customer to control heater function. The user interface consists of buttons for scroll through system menus, adjustment of settings and to provide additional operational status information.

SAFETY

ELECTRICAL SHOCK - Troubleshooting and repairing this water heater can expose you to electrical shock. Some of the diagnostic procedures require the presence of 120 volt AC electricity. Use extreme caution when performing these procedures. When replacing an unserviceable component, turn off all power to the water heater and check for the presence of power with a multi-meter or test lamp. The ignition cable carries more than 10,000 volts of electrical energy. Use extreme caution when diagnosing the Ultra High Efficiency Water Heater.

FLAMMABLE LIQUIDS AND VAPORS - Gasoline, as well as other flammable material and liquids (adhesives, solvents, etc.), and vapors they produce are extremely dangerous. DO NOT handle, use or store gasoline or other flammable or combustible materials anywhere near or in the vicinity of a water heater. The spark ignition and burner assembly in the water heater controls can ignite these vapors. Failure to do so can result in property damage, bodily injury or death.

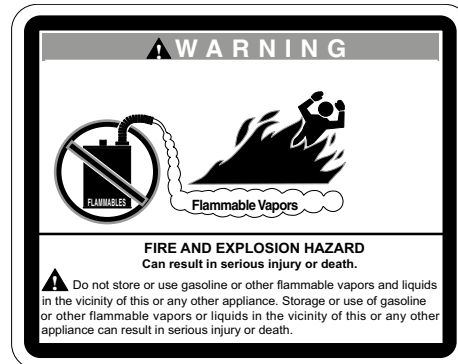

WATER TEMPERATURE ADJUSTMENT - Safety and energy conservation are factors to be considered when selecting the water temperature setting on the thermostat. Water temperatures above 125°F can cause severe burns or death from scalding. The chart shown here may be used as a guide in determining the proper water temperature for your application.

TIME / TEMPERATURE RELATIONSHIPS IN SCALDS	
Temperature	Time to Produce Serious Burn
120° F (49°C)	More than 5 minutes
125° F (52°C)	1½ to 2 minutes
130° F (54°C)	About 30 seconds
135° F (57°C)	About 10 seconds
140° F (60°C)	Less than 5 seconds
145° F (63°C)	Less than 3 seconds
150° F (66°C)	About 1½ seconds
155° F (68°C)	About 1 second

Table courtesy of Shriners Burn Institute

SPECIFICATIONS OF THE TRITON

Models	GHE (gas high efficiency gas) 80, 100 and 119 gallon (tank capacity) Powered direct vent; sealed combustion; fully condensing; ASME rating options on all inputs; power vent options on all inputs.	
Fuel Type	Natural and L.P. gas; thermal efficiency based on model	
Gallon Capacity	80,100 and 119 gallons	
Rated Gas Input (Btu/Hr.)	130,000; 160,000; 199,900; 250,000; 300,000; 350,000; 399,900; 499,900	
Ignition System	Spark ignition to main burner; no pilot of any kind	
Heat Exchanger	Down fired, multi-pass heat exchanger	
Diagnostics	Nonvolatile storage of heater settings and fault history. Diagnostic codes provided through an onboard LCD display consisting of information on power to the control, control status, fault codes and system settings.	
Installation	Indoor only	
Gas Connection	3/4" NPT Female and 1 1/4" NPT Female	
Inlet Gas Pressure	Natural Gas Min. 3.5" w.c. Max. 10.5" w.c. L.P. Gas Min. 11.0" w.c. Max. 13.0" w.c.	
High Altitude	Units rated to 8,999ft. GHE119 up to 10k ft	
Water Connection	2" NPT inlet/outlet – side connect – front and rear 1.5" for Top (Plugged from factory)	
Vent Material Allowed	Polypropylene, PVC, ABS, CPVC plastic pipe options 130-160kbtu – 2", 3" & 4" venting options 199-499kbtu – 3", 4" & 6" venting options SEE USE AND CARE MANUAL	
Maximum Vent Lengths	SEE USE AND CARE MANUAL	
Noise Level	60 db @ 15 feet (max) using test ANSI S12.34/ISO 3744	
Water Temperature	Factory Setting	120°F
	Digital Thermostat (adjustable)	1 degree increments
		85°F to 185°F
Temperature Differential	Factory Setting of 12°F User selectable from 1°F to 30°F	
Electrical	Electrical Rating	120 VAC 50/60Hz, 7 Amps
	Wire	3 (three) wire (hot, neutral, ground)
	Earth Ground Sensitive	Yes
	Polarity Sensitive	Yes
Safety Devices	Temperature and Pressure Relief Valve – 150 PSI or 210°F	
	Venting Over Temperature Switch; trips at 160°F; automatic reset	
	Energy Cut Off for high water temperature; trips at 205°F (auto reset) +- 3°F	
	Flame Rectification - The presence of a flame is measured via a flame rod that points into the flame. Control measures => 0.5 micro amp (uA)	
	Fuse protected main controller	

SPEED TABLE

Model Name	Model ID	Fuel Type	Combustion Blower Speed (RPM)			Purge Timing (Seconds)
			Min. Speed	Max. Speed	Ignition Speed	
Model Not Selected	0	N/A	N/A	N/A	N/A	N/A
GHE80-130	1	Natural Gas	3400	5400	3400	17
		Propane	3400	5400	3200	
GHE80-160	2	Natural Gas	3400	6600	3400	17
		Propane	3200	6600	3200	
GHE80-200	3	Natural Gas	3000	4800	3000	17
		Propane	3200	4900	3200	
GHE80-250	4	Natural Gas	3000	6300	3000	17
		Propane	3200	6300	3200	
GHE80-300	5	Natural Gas	3000	7400	3000	17
		Propane	3200	7500	3200	
GHE100-130	6	Natural Gas	3400	5400	3400	17
		Propane	3200	5400	3200	
GHE100-160	7	Natural Gas	3400	6600	3400	17
		Propane	3200	6600	3200	
GHE100-200	8	Natural Gas	3400	4900	3400	17
		Propane	3200	4900	3200	
GHE100-250	9	Natural Gas	3400	6300	3400	17
		Propane	3200	6300	3200	
GHE100-300	10	Natural Gas	3400	7400	3400	17
		Propane	3200	7600	3200	
GHE100-350	11	Natural Gas	3400	7800	3400	17
		Propane	3200	6900	3200	
GHE100-400	12	Natural Gas	3400	8700	3400	17
		Propane	3200	7900	3200	
GHE119-500	13	Natural Gas	2800	8850	2800	25
		Propane	2800	8850	2800	

COMPONENT PARTS GHE80SS, GHE80SU, GHE100SS, GHE100SU

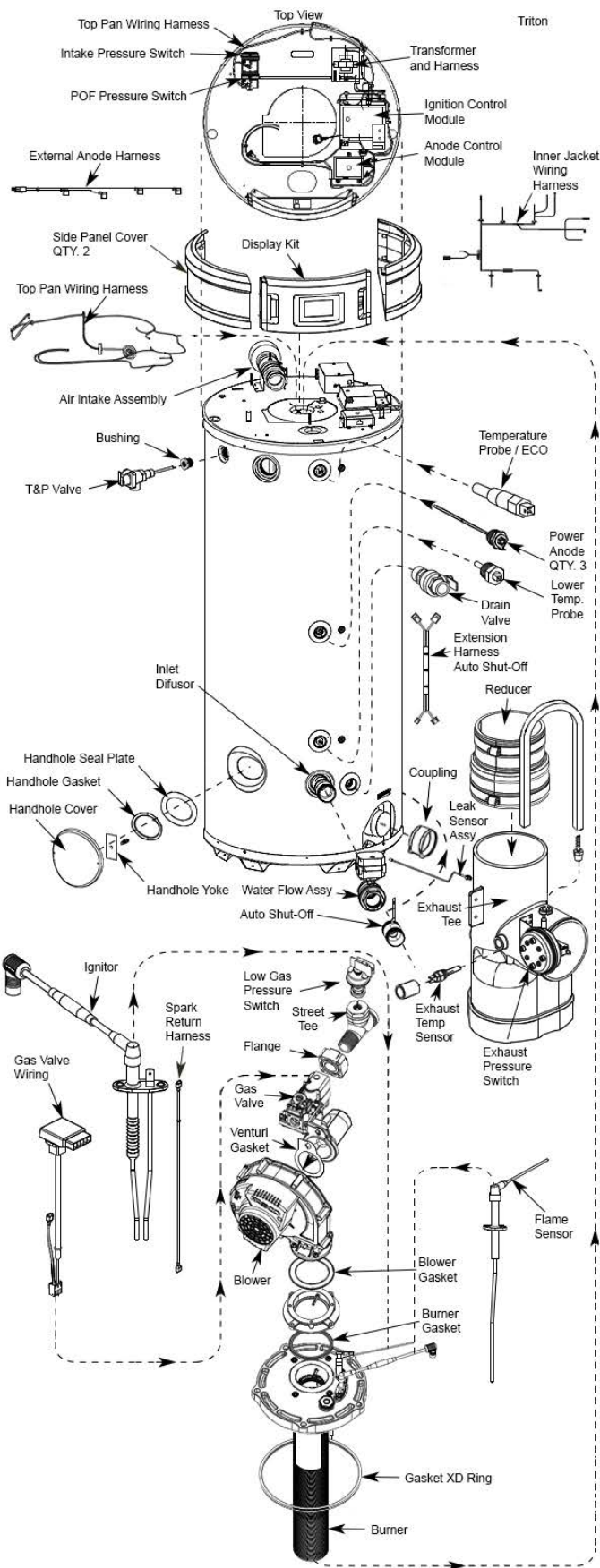

COMPONENT PARTS GHE119SS, GHE119SU

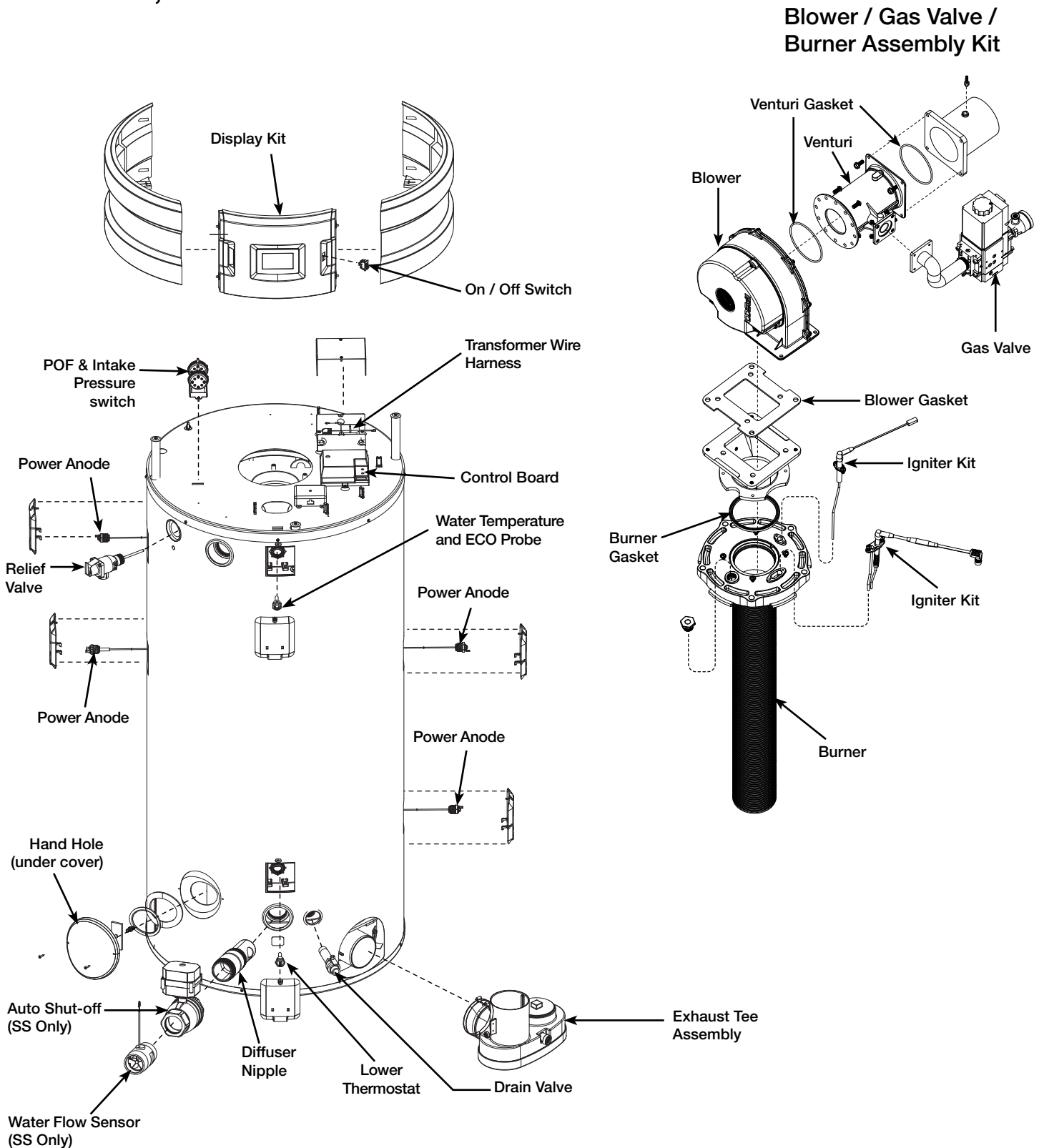

WIRING AND SCHEMATIC DIAGRAM GHE80SS, GHE80SU, GHE100SS, GHE100SU

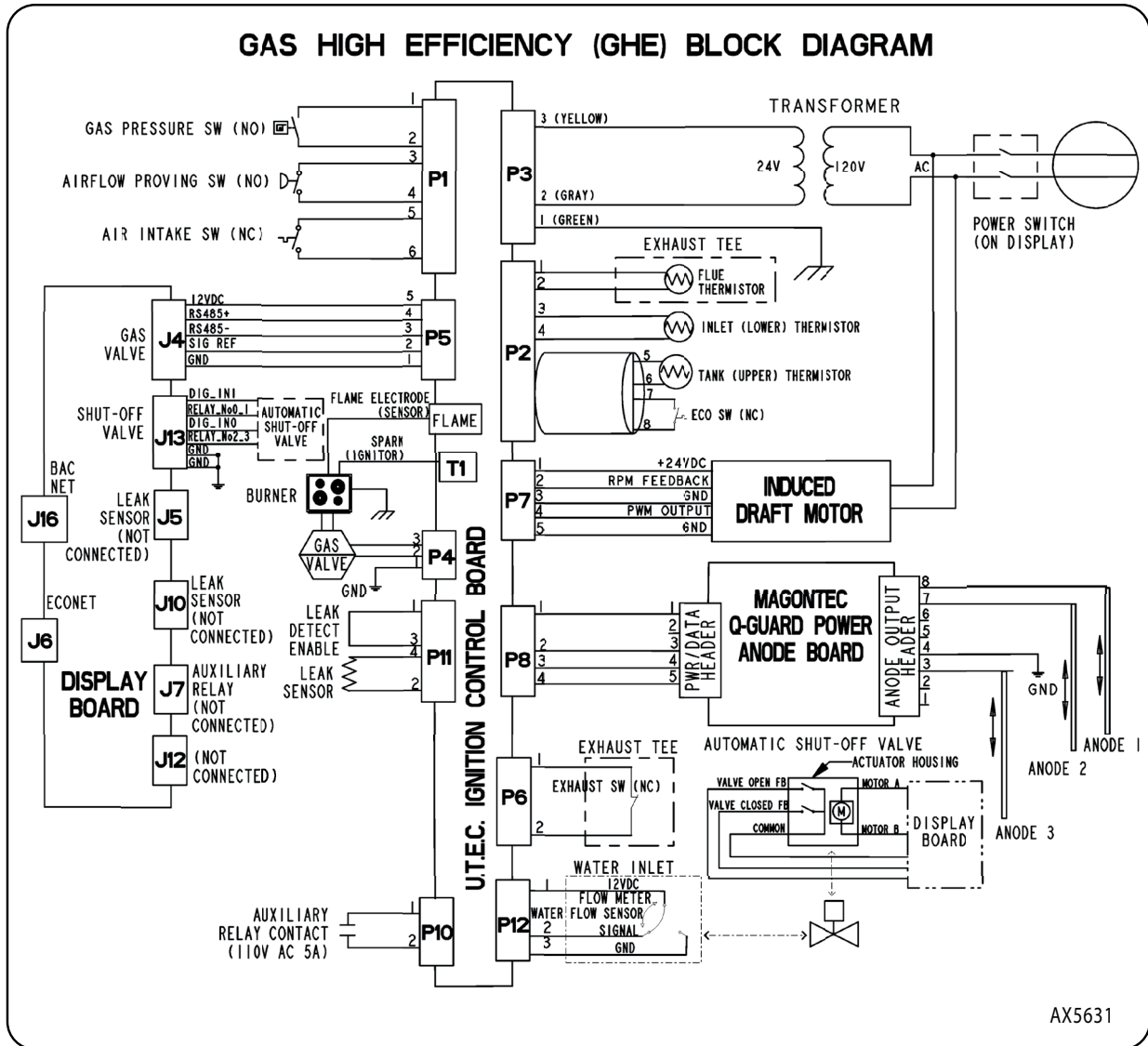

WIRING AND SCHEMATIC DIAGRAM GHE119SS, GHE119SU

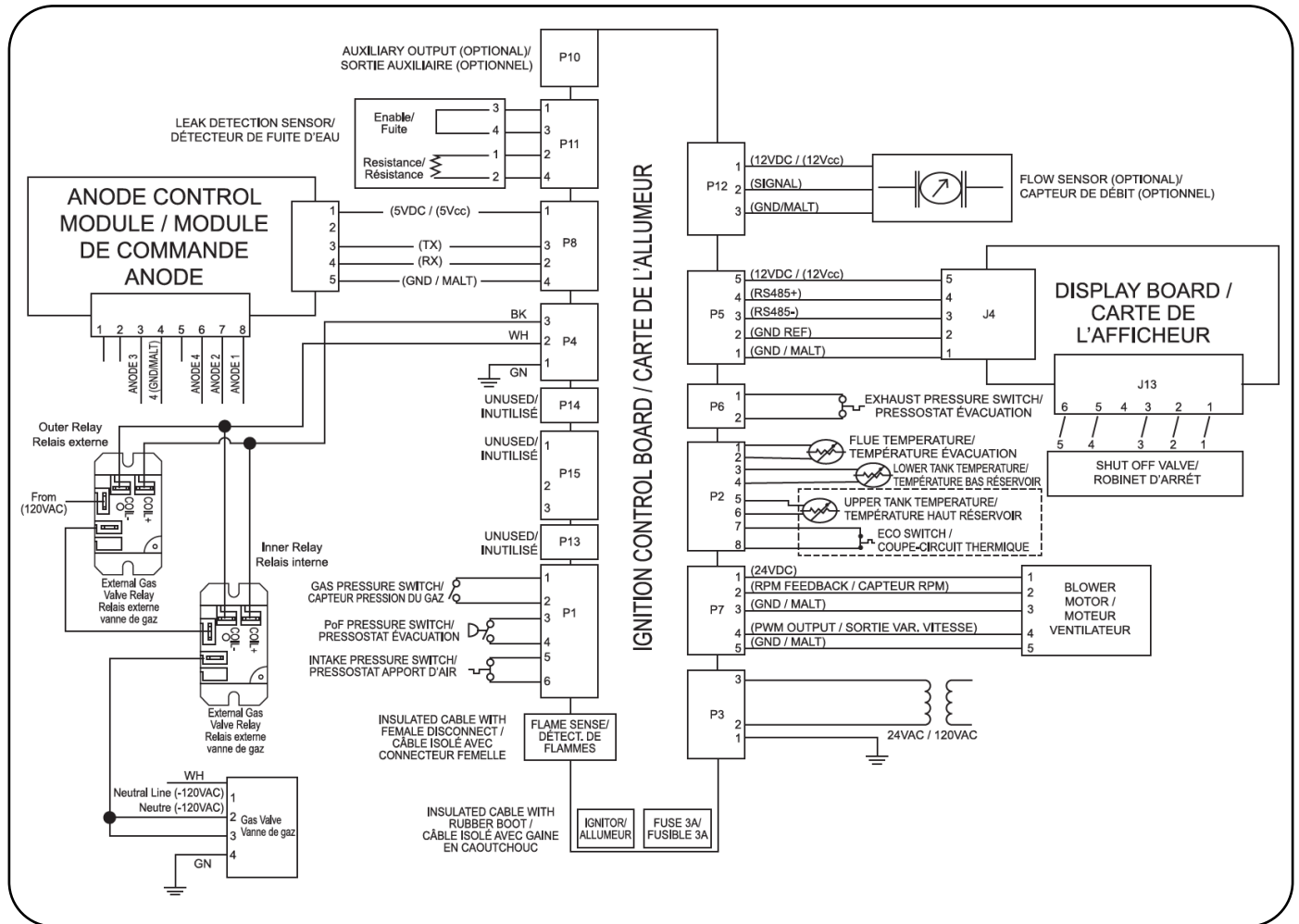



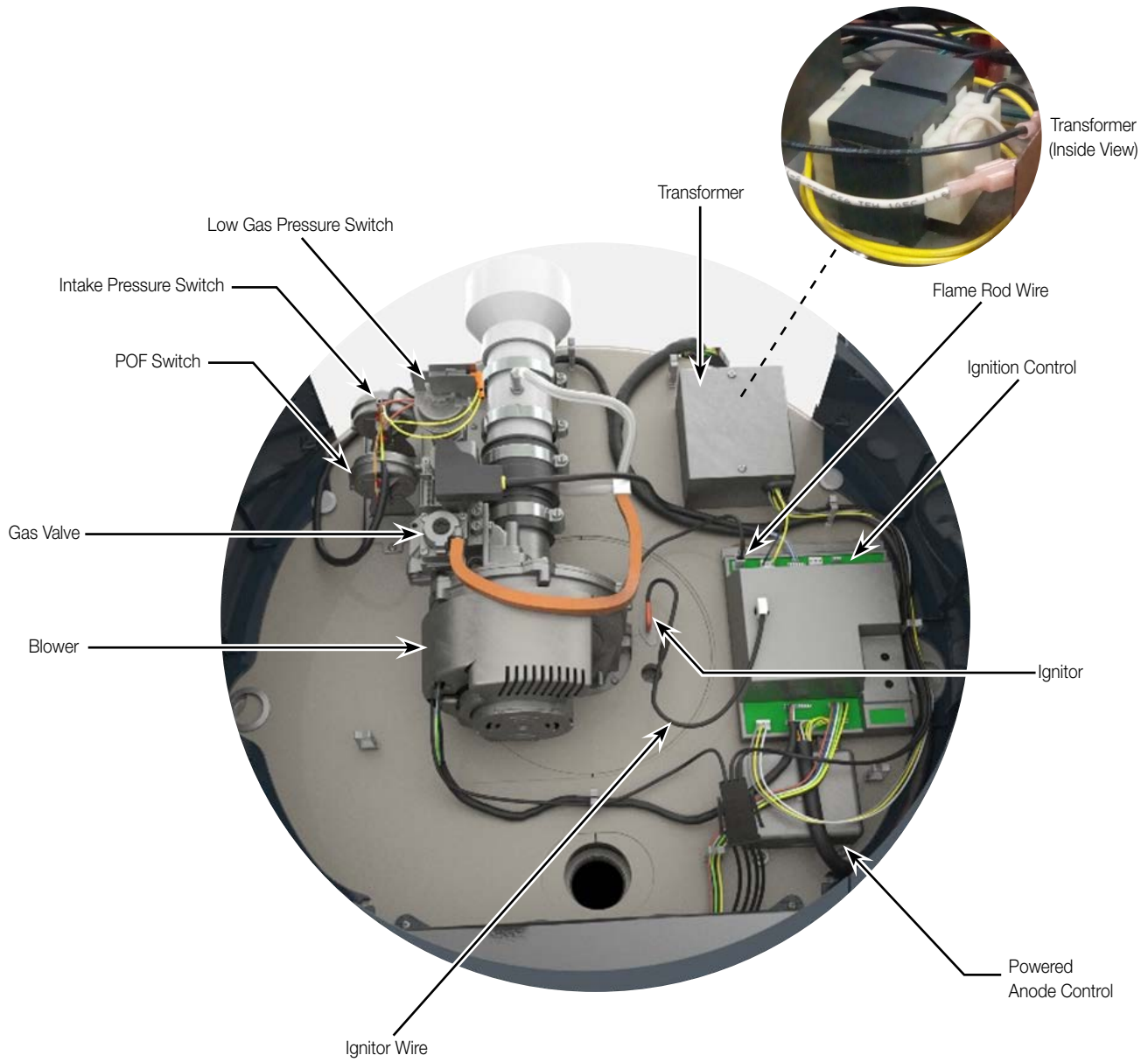

TOP VIEW GHE80SS, GHE80SU, GHE100SS, GHE100SU

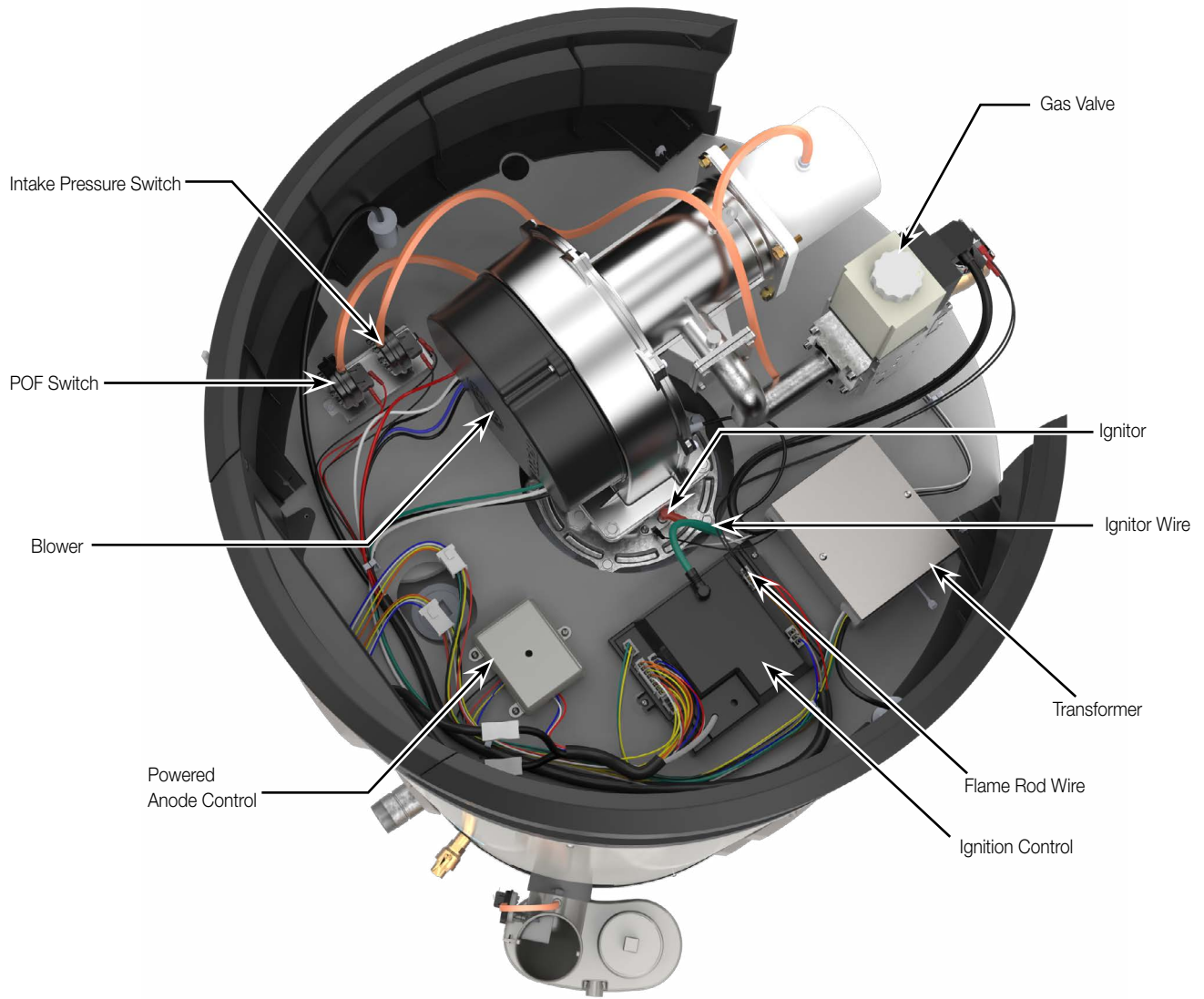





TOP VIEW GHE119SS, GHE119SU GHE119SS, GHE119SU

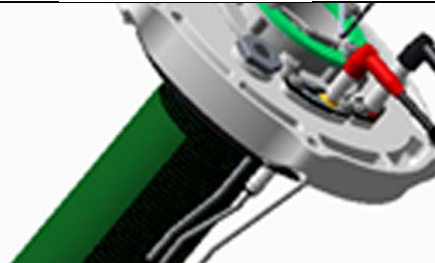

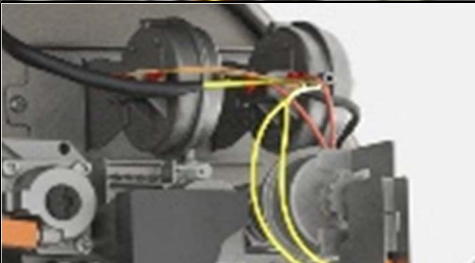

PARTS

Part Name	Description	Picture
Blower	This is a variable speed blower by Fasco, is matched to gas valve. The speed and function of the blower is monitored by the main controller.	
Gas Control Valve	The gas valve, by Honeywell, is matched to the blower motor. Their functions are controlled by the primary controller.	
Flue Gas Temperature Sensor – Exhaust	Measures the temperature of the combustion gases at the discharge vent of the water heater. This normally closed switch has a trip setting of 160°F.	
Power Anode Controller	The power anode controller controls the current flowing through each anode. The anode system is protecting the tank against corrosion. The power anodes can be checked through menu options under “system” and check “tank health” to see the power output of the anodes. The closer to 100% power, the more bare metal there is in the tank. Anode controller has LED flash code indicators to determine if there is communication between the controller and anodes. Anodes can be unplugged if anode or wiring is damaged.	
Condensate Trap (Included in the Exhaust T)	With an efficiency of greater than 90%, this unit will create much condensation inside the flue tubes. The condensate trap allows for the controlled evacuation of the condensation to a local drain. (See local codes)	
Igniter and Flame Probe	Provides spark to burner and flame rectification response to the controller.	

PARTS

Part Name	Description	Picture
Main Igniter Controller	<p>The control provides outputs for a blower motor, high voltage spark igniter, gas valve, and nonvolatile storage of fault history. The control receives inputs from temperature probe, pressure switches, Flue gas temperature sensor, high temperature limit switches and senses flame. The control makes 9 tries of 3 attempts (total of 27 tries) for ignition. If no ignition, the control waits for one hour before re-attempting ignition.</p>	 <p>A photograph of the main igniter controller printed circuit board (PCB). It features a digital display at the top left, a large white rectangular component in the center, and various electronic components like capacitors and resistors. A label on the board reads: MODEL # 1214-100, RHEEM PART # AP17384, 24VAC, 500mA, 5050R2.</p>
LCD Display and User Control Panel	<p>Color LCD with touch sensitive overlay for user interface. Displays tank set point temperature, operational state, and various other operational characteristics of the water heater.</p>	 <p>A close-up photograph of the LCD display and user control panel on the front of a water heater. The screen shows a temperature setpoint of 120°F and various control icons.</p>
Proof of Fan (Pressure Switch)	<p>The PoF pressure switch confirms the blower motor is running. Each switch is available individually.</p> <p>Switch is normally open.</p>	 <p>A photograph showing the wiring for a Proof of Fan (PoF) pressure switch. Red and yellow wires are connected to a small component, likely the pressure switch, which is part of the blower motor assembly.</p>
Blocked Inlet (Pressure Switch)	<p>The blocked inlet pressure switch is a normally closed contact that opens with a fall in pressure.</p> <p>Each switch is available individually</p>	 <p>A photograph showing the wiring for a blocked inlet pressure switch. Red and yellow wires are connected to a component, likely the pressure switch, which is part of the water heater's inlet assembly.</p>
Water Temperature and ECO Probe	<p>This probe provides the water temperature to the controller; and also provides an energy cut off in the event the water gets too hot (>200°F).</p>	 <p>A photograph showing the water temperature and ECO probe installed in the tank of a water heater. The probe is a cylindrical component with a sensor tip inserted into the tank.</p>
Lower Temperature Probe	<p>This probe provides the lower tank temperature to the controller.</p>	 <p>A photograph showing the lower temperature probe installed in the tank of a water heater. The probe is a cylindrical component with a sensor tip inserted into the tank.</p>

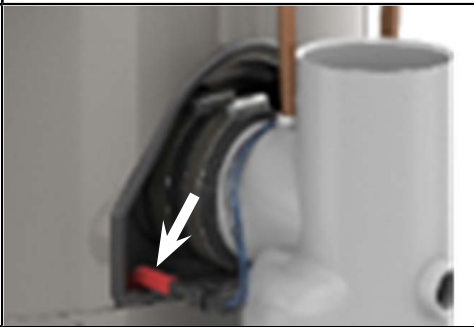
PARTS

Part Name	Description	Picture
Leak Sensor	<p>This sensor detects water when 2.5-5mL of water is present. It is installed in the bottom pan of the unit and has a splash proof guard above it so tank condensation or sprayed water will not activate it. Unit can operate with sensor unplugged but the display will flash an alert stating that the leak sensor is disconnected. Factory setting for leak detection is to "Alert Only". Can be changed to "Disable"(Shut down the unit if a leak is detected.)</p>	
Burner	<p>The burner in a combustion chamber maintains a controlled flame by giving the flame a structure to rest on.</p>	

NAVIGATING THE HOME SCREEN

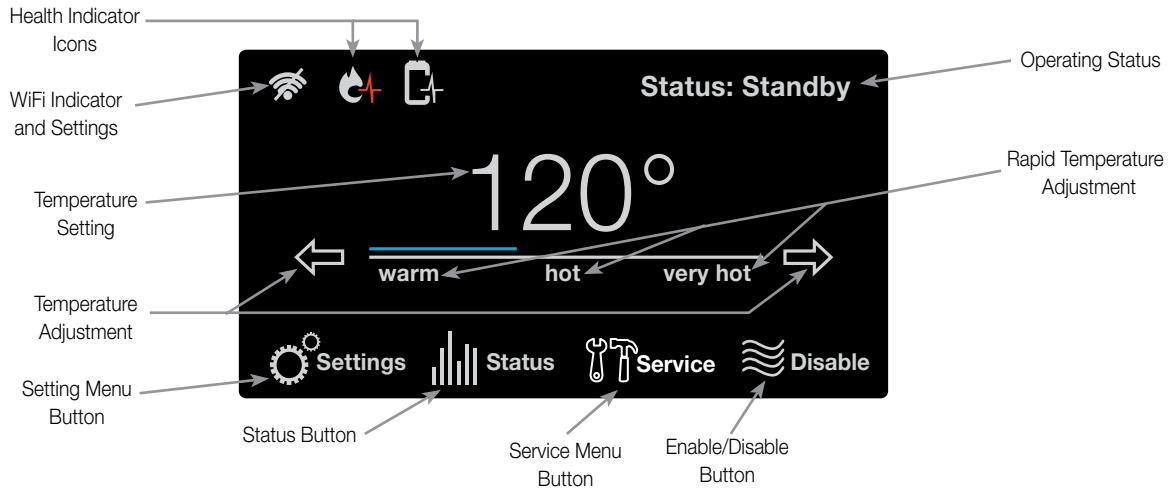

STARTUP - Once power is applied to the water heater and the On button is pressed, the Startup Wizard on the LCD will go over the below features:

1. Setting of Time and Date
2. Setting Hours of Operation for the business
3. Wifi Setup

Follow the on-screen instructions to complete setup. Some of these items can be skipped if a later setup is desired.

ENABLING (TURNING ON) THE UNIT

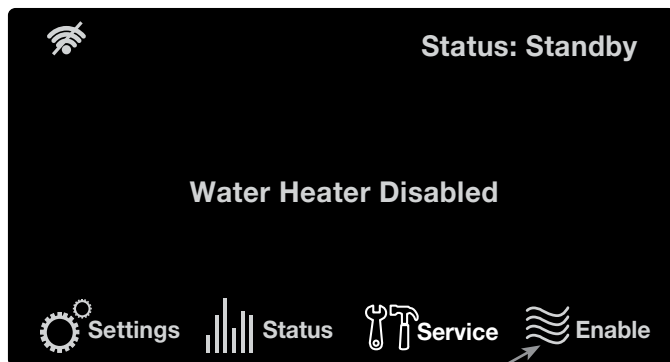

Press the enable button to turn the water heater on

TEMPERATURE ADJUSTMENT - Tank temperature will be maintained according to the setting on the home screen. If the water temperature setting needs adjustment, use the arrows on the display to select desired temperature. The display also has a rapid temperature adjustment feature that corresponds to the below temperature settings.

Warm: 110°F

Hot: 140°F

Very hot: 180°F

Touching the text 'warm', 'hot', or 'very hot' will adjust the temperature to the above temperature setting.

SETTING MENU - The settings function on the water heater display allows access to the basic settings, configurations, schedules, bacnet, and the time/date.

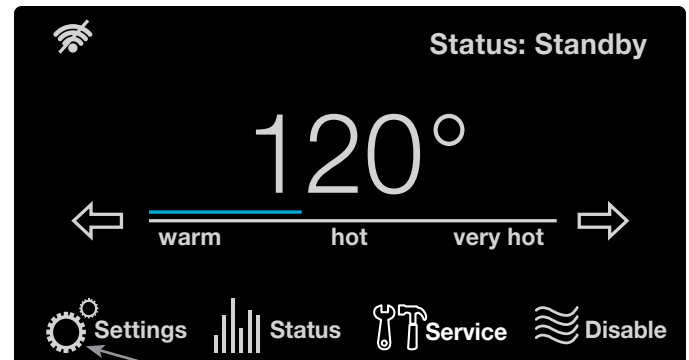

Pressing the settings button will allow access to water heater settings

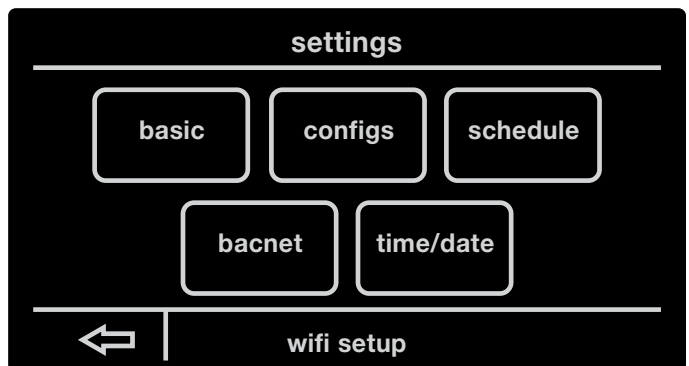

USER INTERFACE

BASIC SETTINGS - The basic settings in your water heater can allow you to change the temperature unit, screen adjustment lock/unlock, enabling/disabling the alarm beep, and your EcoNet network instance. Simply select the setting by tapping it, and press the Up/Down arrows to make adjustments. WiFi setup can be accessed from this screen as well.

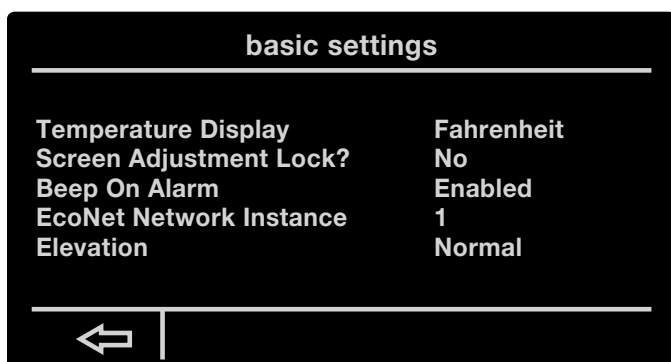

CONFIGURATION SETTINGS - The configuration settings on your water heater allows you to control the differential temperature set point, turning on/off the recirculation pump, auxiliary input/output, enabling/disabling modulation, and how your hot water heater reacts to a detected leak.

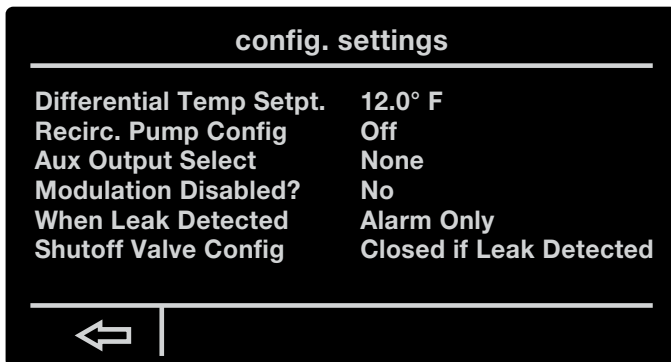

The setting can be highlighted by tapping and then adjusted with the up/down arrows.

The Differential can be adjusted from 1°F to 30°F. The recommended differential is 12°F.

This water heater has a modulation algorithm that can be disabled by tapping 'No' in front of Modulation Disabled and making adjustments by tapping the up/down buttons.

Water heater behavior in response to leak can be changed from Alarm Only to Disable When Leak Detected.

Shutoff Valve (on premium models only) behavior response can be selected to the following:

- Open
- Closed

- Close if Leak Detected: Always close the valve when leak is detected.
- Close if Unocc. Leak Detected (based on unoccupied times from the schedule function). Water heater will alarm only during the operating hours.

SCHEDULE SETTINGS: The schedule settings allows you to control when your hot water heater will be enabled/disabled. Your heater allows you to select a day you want and set the times when the heater will be in use. You can also copy/paste the day you select and apply it to other days as well.

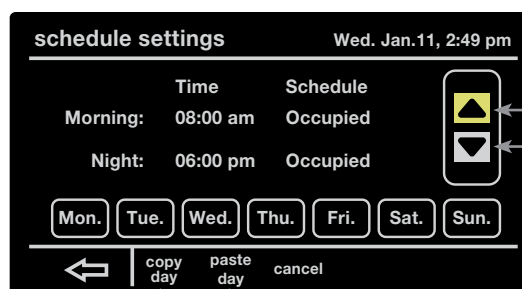

By selecting a day and then accessing the copy function, you can paste that day's settings onto other

The up/down arrows enable you to adjust the time of the morning/night run times.

TIME/DATE SETTINGS: By selecting time/date you can change the water heaters current set time. You can also select the daylight savings time function to automatically adjust the time for daylight savings.

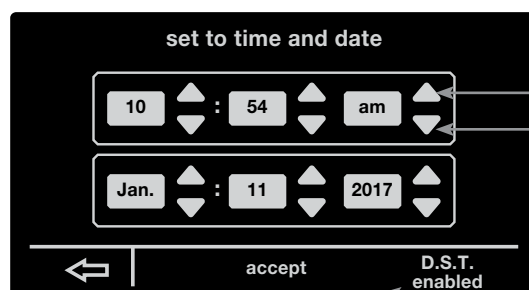

The D.S.T function allows you to adjust the time for daylight savings time.

The up/down arrows allow you to control the time, month, day, and year.

BACNET - This water heater is compatible with BacNet MS/TP protocol. Please refer to the GHE BacNet instruction sheet for details on the setup.

USER INTERFACE

STATUS MENU - The Status screen provides information on the current operating status, diagnostics and sensors. This screen also provides information on the WiFi status.

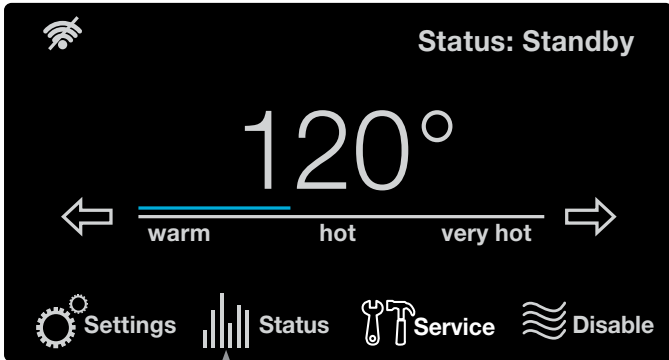

By pressing the Status button, you will be taken to a prompt showing the state of your water heater's many features.

MORE FUNCTION - Selecting the more function your heater will bring you to a prompt showing you the current temperatures of the lower/upper tank, Flue temperature, ECO switch state, and Auxiliary relay state.

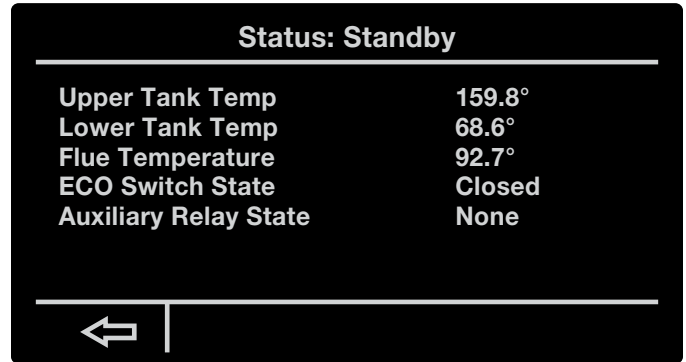

SERVICE MENU - The service screen provides information on the product description, alarms, system health, and service alerts. Alarm details can be found in the "Before You Call Service" section of the manual.

In case there is an active alarm, the "Service" button will blink on the home screen. Pressing the "Service" button will show a new screen containing the active alarms and alarm history.

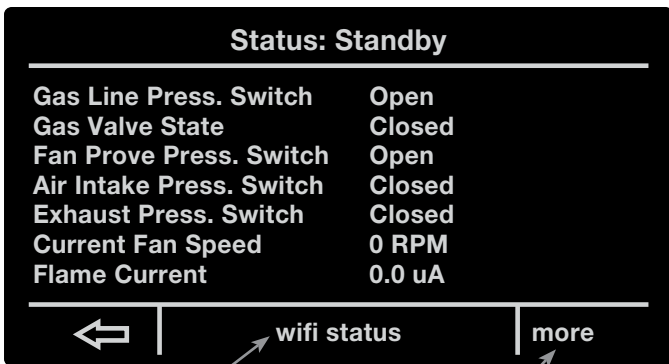

By selecting Wi-Fi status, you can access the status of your water heater's Wi-Fi and even set it up.

By selecting more, you can access the temperatures of your water heater, ECO switch state, and auxiliary switch state.

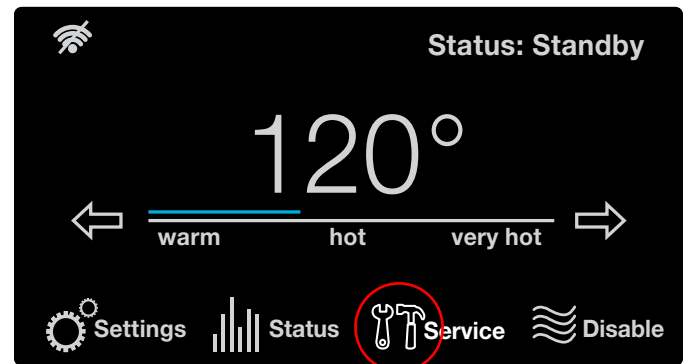

By selecting the service function, you will be taken to a prompt giving you access to the heater's alarms, health, and alerts.

WI-FI STATUS - After selecting the Wi-Fi status function, you will be brought to a prompt showing you the current state of your water heater's Wi-Fi and the ability to set-up your water heater's Wi-Fi.



Selecting the Wi-Fi setup function will bring you to a prompt allowing you to connect your water heater to your home Wi-Fi.

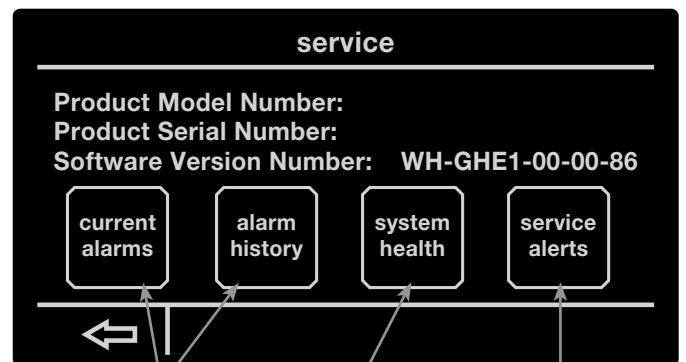

Current Alarms and Alarm History allows you to access any current alarms that have been tripped and view a list of previous alarms.

System Health will show you the status of the tank's combustion health and overall tank health.

Service Alerts will allow you to set how often you want to be alerted to check venting, clean the drain trap, replace the neutralizer, and to drain and inspect the tank.

USER INTERFACE

ALARMS - The current alarms function allows you to see any problems that have been detected by your water heater. Also, by selecting on the current alarm you can press “more info” to read more on the current problem of your water heater. Alarm history allows you to see any of the previous alarms that have gone off in the past and give you the ability to clear those previous alarms.

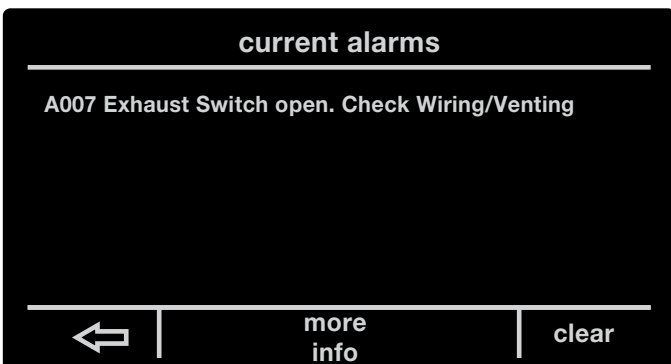

By selecting “more info” you can be given a more in-depth explanation of the current alarm.

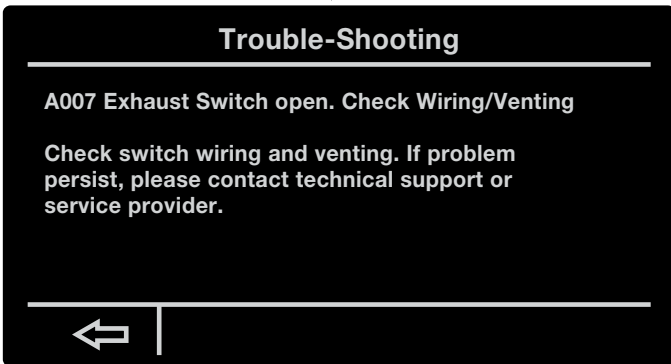

ALARM HISTORY - The alarm history function allows you to see the previous alarms that have been detected by your water heater in the past.



SYSTEM HEALTH - The system health function allows you to see the current health of your hot water heater’s combustion

health and tank health status. The combustion health and tank health each have three levels of health:

This symbol will appear on your home screen if your combustion health is critical. Pressing this icon will take the user to the Health Status Screen

This symbol will appear if your tank health status has reached critical. Pressing this icon will take the user to the System Health Screen

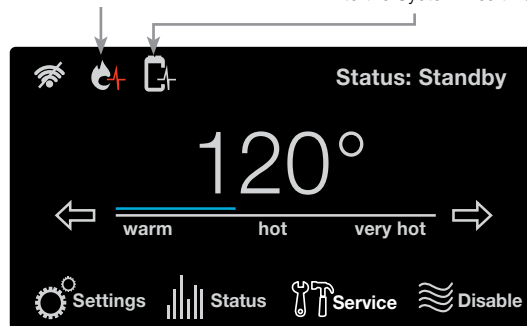

Combustion Health:

1. Normal operation -no action needed
2. Reliability Decreasing -begin planning for service and/or replacement.
3. Needs Servicing - contact your service provider

Tank Health:

1. Powered anode protecting tank - no action needed
2. Anode protection ending -begin planning for service and/or replacement.
3. Anode no longer protecting tank. -contact your service provider.

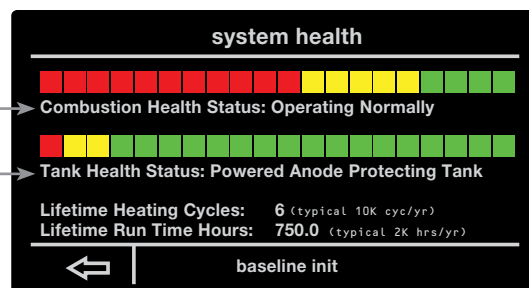

The health of your system’s combustion system and overall health can be seen here. This screen be accessed by tapping the health indicator icons on the home screen.

SERVICE ALERTS - By selecting the Service alerts function you will be able to adjust how often you want to be alerted to drain and inspect the tank, clean the drain trap, check the venting, and to replace the neutralizer.



By selecting an option and then using the up and down arrow, you can set how often you’d like to be alerted to system maintenance.

DISPLAY MESSAGES ON CONTROL BOARD

Status Message	Description
Water Heater Disabled	The water heater is disabled and not in any active mode.
Standby	The water heater is in a non-active mode where the temperature of the water in the tank is within the set point limits.
Pre- Purge	An initial step in a heating cycle wherein the blower is energized to clear any potential by products of combustion from the heat exchanger.
Ignition	The ignition system and gas valve are energized during this period. Igniter should be sparking and gas valve should be releasing fuel.
Heating	This message appears when a call for heat is present and the burner is actively firing.
Post Purge	When the call for heat is satisfied, the gas valve is de-energized while the blower remains energized to clear the heat exchanger.
Retry	Test failed ignition and it is retrying
Recycle	The water heater is in the 30 minute delay between retries
Fault	The water heater is experiencing a malfunction and displaying an error code
Ign. Control Comm Error	The display is not communicating with the ignition control

SEQUENCE OF EVENTS

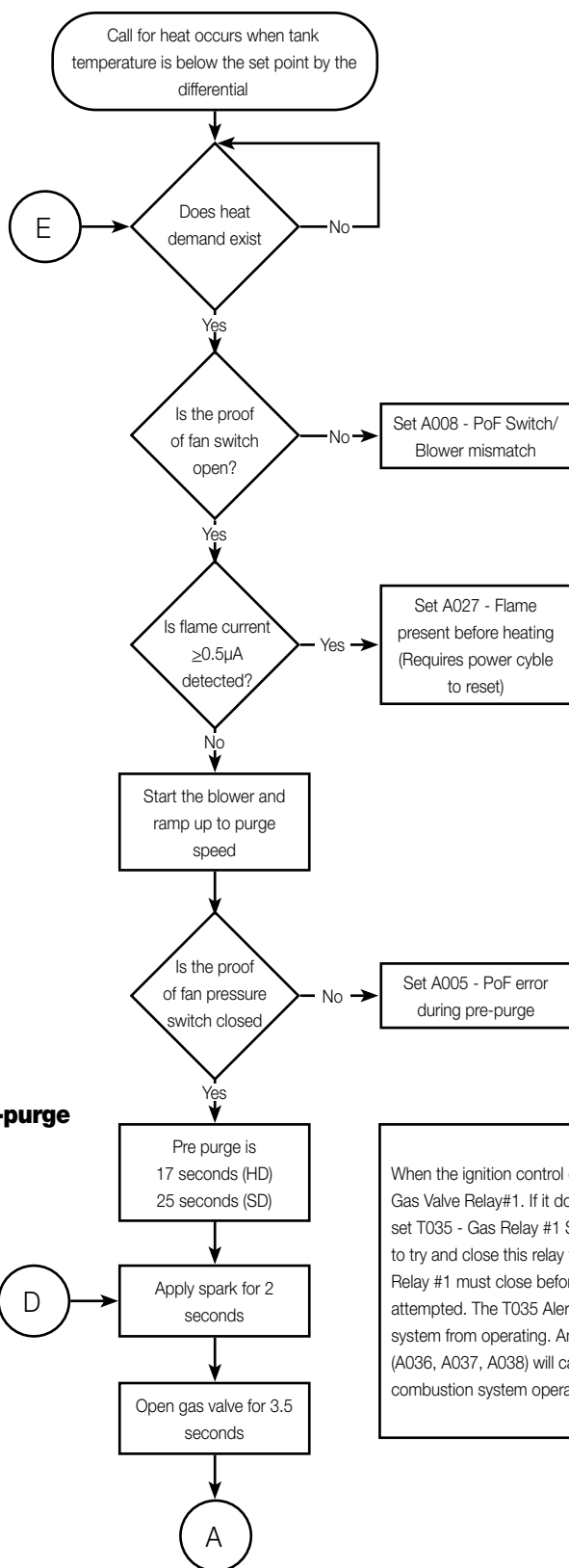

The Triton ignition control periodically run self check routines for hardware faults. Any detected fault will lock out the unit and prevent combustion. It will check every hour and if the condition clears it will return to normal operation. A power cycle may also clear the condition. Hardware faults are detailed in the use and care manual.

The presence of any "A0- series fault will prevent operation. If in a heating cycle when the alarm occurs combustion will be stopped and the unit will lock out until the condition is resolved.

The inlet pressure switch and the exhaust (flue) pressure switches are normally closed switches. If either switch opens (>4 seconds) at any time the ignition control will close the gas valve and stop combustion and set the appropriate alarm code (A003-Intake Switch Open and A007 - Exhaust Switch Open). The blower will initiate a call for heat (unless heat demand was satisfied). If the switch is still open after 30 seconds the blower is secured. If the switch closes and a heat demand exist the control will initiate a call for heat. All pressure switch operations require a 4 second persistency to be recognized by the control. The proof of a fan pressure switch is ignored by the control during ignition.

Concerning the proof of fan switch behavior, if the pressure switch remains open after the inducer has run 60 seconds, the control will de-energize the inducer for 30 seconds. After 30 seconds, the control verifies the pressure switch remains open and re-energizes the inducer. If the pressure switch was found closed, the control changes the fault code to stuck closed switch (A008) and waits indefinitely for the pressure switch to open. This 60 second run / 30 second off shall continue as long as a call for heat exist until the pressure switch is proven.

Pre-purge

When the ignition control opens the gas valve it first closes Gas Valve Relay#1. If it does not sense the relay closed it will set T035 - Gas Relay #1 Stuck Open. The control will continue to try and close this relay to satisfy heat demand. Gas Valve Relay #1 must close before closure of Gas Valve Relay #2 is attempted. The T035 Alert will not prevent the combustion system from operating. Any other Gas Valve Relay alarms (A036, A037, A038) will cause a Fault condition and prevent combustion system operation.

SEQUENCE OF EVENTS

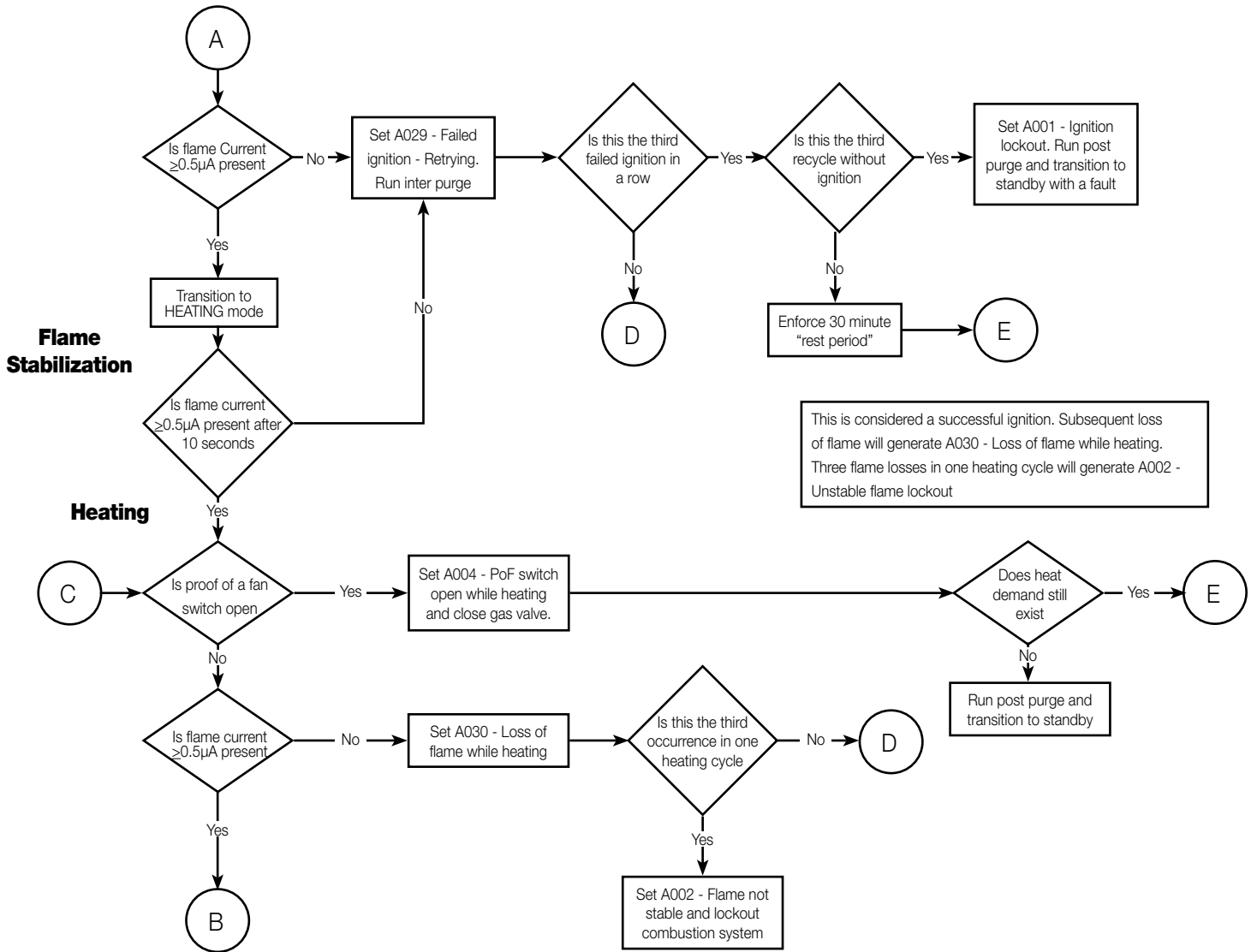

SEQUENCE OF EVENTS

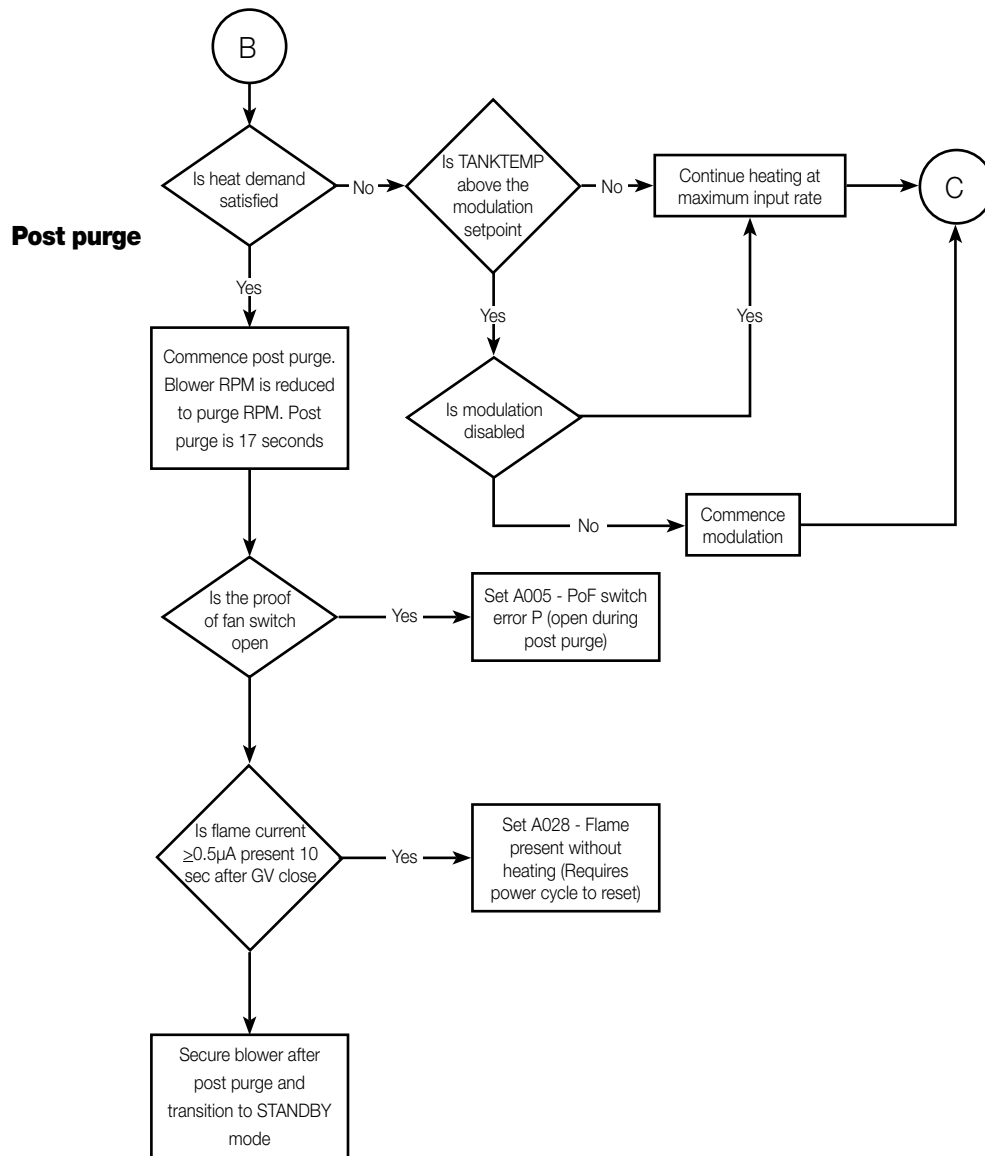

Modulation will start when:
 $TANKTEMP > (WHTRSETP - (WHTRDIFF/2))$.
 During modulation the blower RPM is decreased linearly until it is running at minimum RPM as $TANKTEMP = WHTRSETP$

SEQUENCE OF OPERATIONS

Upon application of power, the controls performs an internal check, retrieves and inspects relevant data from Electrically Erasable Programmable and Read Only Memory (EEPROM), and analyzes the 120 VAC power line for polarity and ground connections. After the control performs selected system diagnostic checks and if all checks are

successfully passed, the control measures water temperature. Whenever the water temperature is less than the set point minus the differential, an internal call for heat is generated. The burner is then allowed to run until the “call for heat” is removed when the water temperature is equal to or greater than the set point.

Power ON

When the control is powered, it should display the Rheem heater model, water temperature, operating setting temperature and heater status. (If temp is above 120°, a scald warning will appear)

If the control determines that the actual water temperature inside the tank is below the programmed temperature set point minus the differential, a call for heat is activated.

Water temperature thermistor (thermostat) measures the water temperature inside the tank.

The control will not initiate a call for heat while in any lockout condition.

Resolve any error codes in the LCD display.

Call for Heat

On a call for heat, the microprocessor runs its self-check routine and clears the retry counters. The control then performs selected system diagnostic checks. This includes confirming the proper state of the pressure switches, exhaust flue temperature, water temperature sensors and ECO high limit device.

Checks to make sure the ECO is not tripped.

Checks to make sure that flue gas temperature is less than 160°F (normal state).

Checks to make sure the pressure switch (proof of fan) is OPEN (normal state) prior to activating blower.

Check that the ECO is not open; verify water temperature is below 200°F. If the ECO is tripped, you will get an error code of A016.

Check flue gas sensor. Resistance reading should be within the range in Chart on page 38. If the flue gas temperature exceeds 155°F, the controller will indicate an error code of A017

Check Proof of Fan pressure switch. Continuity indicates a closed or damaged switch. If POF switch is closed before activation of the blower, you will get an error code of A008.

The system will energize the blower once the pressure switch is detected open. If all checks are successfully passed; the combustion blower is energized for the pre-purge cycle.

Blower will operate at ignition speed for up to 30 seconds to close the Proof of Fan switch.

If Proof of Fan switch is open, pre-purge continues while control board checks if pressure switch closes. If POF switch is not open, you will get an error code of A008.

SEQUENCE OF OPERATIONS

Pre-purge Cycle

If PS closes, then control board initiates the pre-ignition cycle. The pre ignition period verifies the controllers gas valve relays are open.

The word **pre-purge** will be in the LCD display window.

Pre-purge lasting 5 seconds will check to make sure the venting is not blocked and any unfavorable combustion gases are expelled.

Gas valve relays are checked to make sure they are open.

If controllers gas valve relay 1 is not OPEN you will get an error code of A036

If the proof of fan pressure switch does not close, you will get an error code A005, pre-purge and A004 during the heating cycle.

Ignition Activation Period

The igniter sparks for 2 seconds. During the trial for ignition, the gas valve will open allowing gas to enter the burner chamber.

The word Ignition will be in the LCD display window.

The spark ignition circuit is activated.

Blower is operating and there is power to the gas valve.

Main burner is on. There is no pilot with this machine. It is a Direct Spark Ignition (DSI) burner.

Flame Rectification

The igniter is de-energized when flame is sensed (0.5 micro amps). If no flame is sensed within 3 seconds of the gas valve opening, the trial for ignition period ends and the unit recycles to a second and / or third ignition attempt.

The control will monitor the flame sense probe to confirm that a flame is present.

The control will execute an inter-purge cycle if no flame is sensed.

The inter-purge cycle blows out excess fuel from the combustion chamber.

If a flame is not verified within 4 seconds the gas valve will be closed. If there is no proof of flame after the three ignition attempt cycles (total of 9 attempts), you will get an error code of A001 Max Ignition Attempts.

Once flame is rectified, the spark igniter is de-activated.

If flame exists for more than 4 seconds the retry counter is zeroed.

Main Burner Operation

Once a flame is confirmed, the control will enter the primary heating mode.

The word Heating will be in the LCD display window.

Main burner is now in Heat Mode and the controls heat the water in the tank. It will continue heating the water in the tank until the set point temperature is reached.

The control enters normal operating loop where all inputs are continuously checked. Combustion blower will accelerate to maximum speed based on BTU input.

SEQUENCE OF OPERATIONS

End of Heating Cycle

Once the set point is reached, the gas valve is closed and the control enters the post purge cycle.

Post purge expels latent heat and combustion gases.

If there is a presence of flame 10 seconds after the gas valve relays close, you will get an error code of A019 Flame Out To Late.

Post Purge

The blower will run the post purge cycle to purge the burner and venting system of all combustion gases. The word Post Purge will be in the LCD display window.

When the post purge cycle is complete, the blower is de-energized and will stop.

If the proof of fan pressure switch does not close, you will get an error code A006, post purge.

Stand-By Mode

The control will enter the idle state while continuing to monitor the internal tank water temperature and the state of other system safety devices.

The word Standby will be in the LCD display window.

If the temperature drops below the set point value minus differential, the control will automatically call for heat and repeat the entire operating cycle.



SEQUENCE OF OPERATIONS SCREENSHOTS

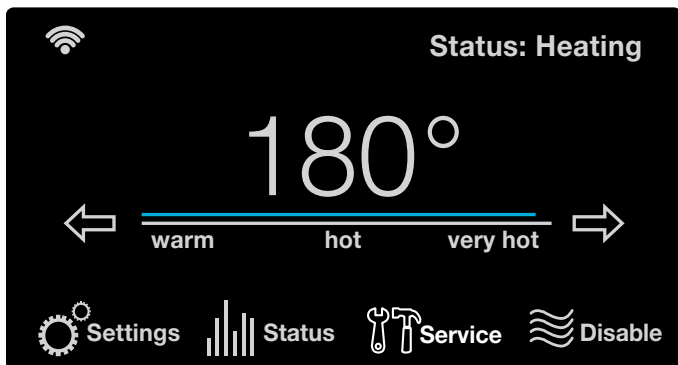
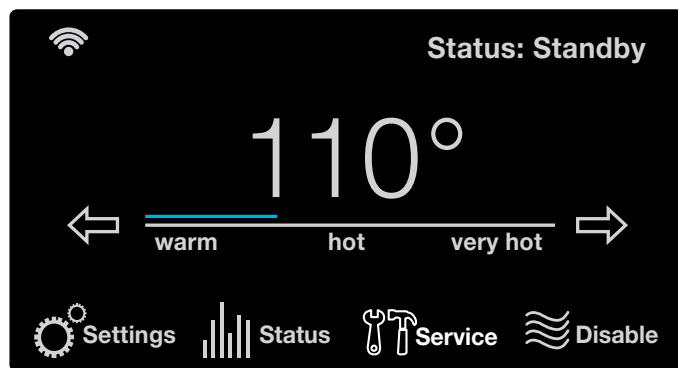
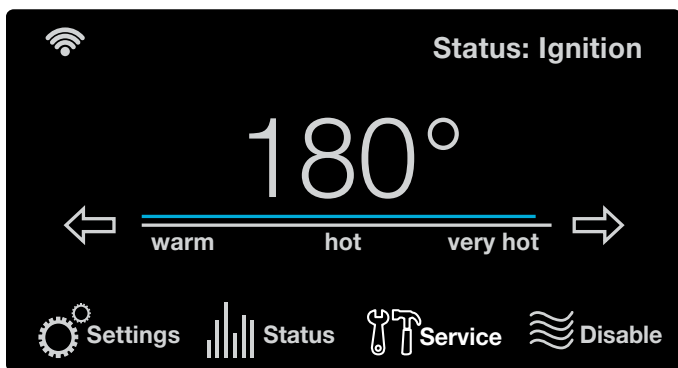
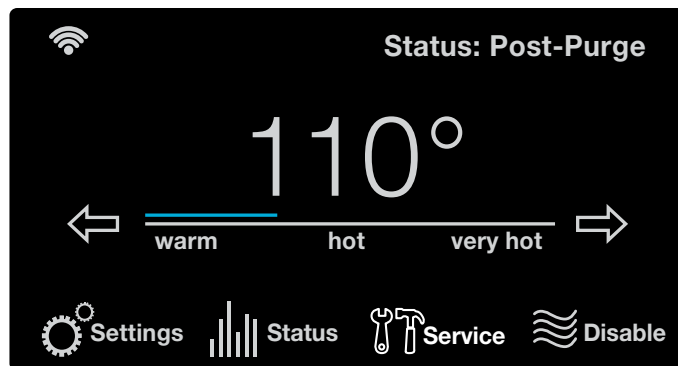
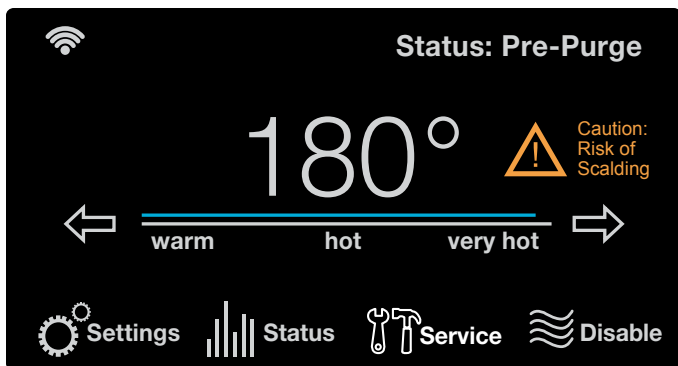

SAFETY FUNCTIONS OF THE CONTROLS

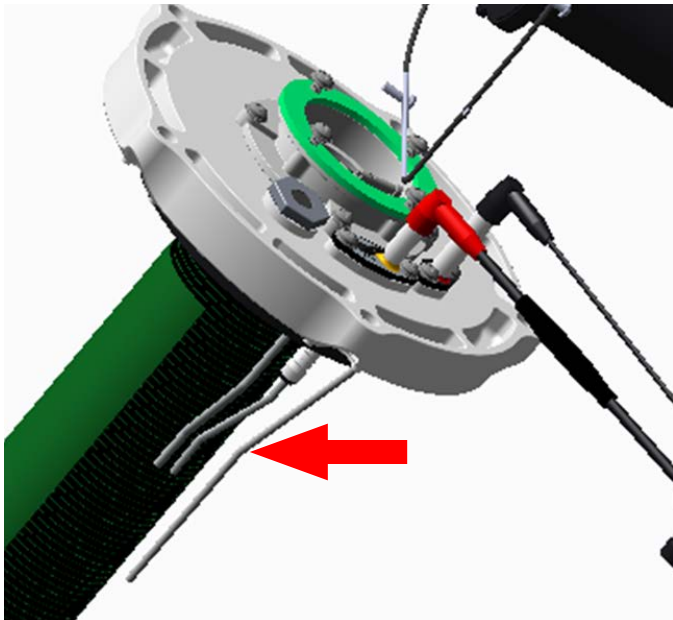

FLAME DETECTION

Proof of flame is accomplished by flame rectification via a burner sensor electrode and earth ground. The presence of a flame is measured via a flame rod that points into the flame. With the flame rod energized and a flame present to bridge the space between the flame rod and earth ground (the burner), the resultant flow of electrons (called the flame current) is monitored by the controller. The controller requires the flame current to attain a certain minimum value (0.5 micro amps) as a means to gauge the quality and stability of the flame. Absent of an acceptable flame current value, the controller will render the heater into an error condition A001/A029 during ignition and start up; or A002/A030 if the unit is in the middle of a heating cycle.



ECO (ENERGY CUT OFF)

The ECO switch functions as a high limit switch responsive when the water temperature approaches 205° F. If the water temperature inside the tank reaches 203° F, the ECO switch

(normally closed) will open. The controller will disable all heating functions and will render the heater into an error condition.

PRESSURE SWITCHES

Pressure switches are incorporated to provide proof of fan (blower) operation and to detect blocked inlet and outlet vent conditions. The controller monitors the status of the normally open or normally closed pressure switches and in the event of abnormal conditions, the controller will render the heater into an error condition.



VENT TEMPERATURE (FLUE GAS) SENSOR

A vent temperature switch is incorporated to detect excessive heat at the vent exhaust location. This protects the plastic PVC piping from damage. The controller monitors the status of the temperature switch and in the event of abnormal conditions (temperatures approaching 155°F decreases the RPM to lower flue temperatures) the controller will render the heater into an error condition.

POWER OUTAGES

The controls will automatically resumes operations after power interruptions.

SAFETY FUNCTIONS OF THE CONTROLS

CONTROLLER RETRY AND IGNITION ATTEMPTS

If the first ignition cycle fails during a normal heating cycle sequence, the control will finish the sequence of the ignition and then de-energize the main gas valve. The blower remains energized and the system is purged for the inter-purge duration. After the inter-purge time expires, the control turns the blower off, waits for the pressure switch to open, and performs a relay check on the gas valve.

The blower is then turned on and waits for the pressure switch to close. Normal ignition sequence is started. Nine ignition cycles are attempted before soft lockout occurs. The control waits 30 minutes, then attempts ignition again. If unsuccessful, the control waits another 30 minutes, then attempts ignition again. The control will go directly to hard lockout after the third unsuccessful ignition cycle (27 attempts at ignition) and post-purge.

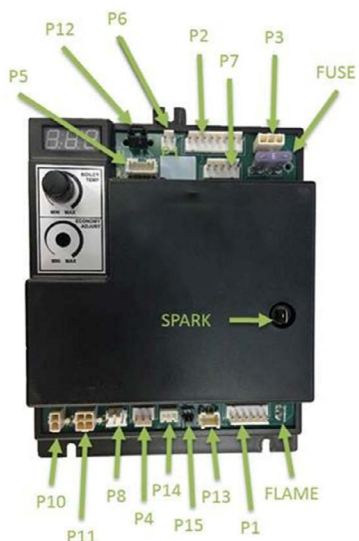

CONDENSATE REMOVAL TUBE WITH EXHAUST TEE ASSEMBLY

An important part of the Triton is the condensate removal tube that comes included in the exhaust T.

During main burner, water vapor is created. As the heat is transferred into the water thru the flue bundles, this water vapor condenses and becomes a liquid. The removal tube provides a way to evacuate this liquid to a local floor drain. Clean out any foreign matter that has accumulated.



NOTE: On models GHE119SS and GHE119SU neutralizer can be added.

ERROR CODES

Provided in the tables below are descriptions of ALL the error messages provided by the ignition control control. Errors can be divided into two groups, ALARM and ALERT.

ALERT errors are indicated by a “T” followed by numeric digits and a description of the error. Alerts disappear when the cause of the alert goes away (an auto-reset function);

ALARM errors are indicated by an “A” followed by numeric digits and a description of the error. Alarm errors cleared by pressing “Clear Alarms” in the “Current Alarms” section of the “Service” menu.

Error Code	Display
A001	A001 Ignition Lockout
A002	A002 Flame is not stable
A003	A003 Intake switch open
A004	A004 PoF Switch error H.
A005	A005 PoF Switch Error E.
A006	A006 PoF Switch error P.
A007	A007 Exhaust Switch Open.
A008	A008 PoF Switch/Blower mismatch.
A010	A010 End Of Line Test Failure
A016	A016 High Tank Temperature.
A017	A017 High Flue Temp.
A018	A018 Flue Temp Sensor Open.
A019	A019 Flue Temp Sensor Shorted.
A022	A022 Upper Tank Sensor open.
A023	A023 Upper Tank temp. too hot.
A024	A024 Upper Tank sensor shorted.
A025	A025 No Blower RPM feedback.
A027	A027 Flame present before ignit.
A028	A028 Flame present w/o heating.
A030	A030 Flame lost during heating. Retrying.
A033	A033 Flue sensor A/D error.
A034	A034 Upper Tank temp A/D error.

ERROR CODES

Error Code	Display
A036	A036 Gas Relay 1 stuck closed.
A037	A037 Gas Relay 2 stuck open.
A038	A038 Gas Relay 2 stuck closed.
A039	A039 Flame sense cct fault.
A040	A040 Controller RAM fault.
A041	A041 Controller ROM fault.
A042	A042 Controller EEPROM fault.
A043	A043 IC Program execution fault.
A044	A044 Processor Clock/Line Frequency Disagree
A101	A101 Configuration Data Restore Failure
A102	A102 Time Clock needs to be programmed
A103	A103 Time Clock not advancing time properly
A104	A104 Water Leak Detected
A108	A108 Ignition Board Communication Failure
A110	A110 Shutoff Valve Test Close Error
A111	A111 Shutoff Valve Test Open Error
A112	A112 Shutoff Valve Not Open
A200	A200 Incompatible Ignition Control SW
T009	No Gas detected. Check gas connections
T020	T020 Lower Tank Sensor Open.
T021	T021 Lower Tank Sensor shorted.
T026	T026 Blower expected RPM vs actual RPM mismatch.
T029	T029 Failed ignition. Retrying.
T032	T032 Lower Tank temp A/D error.
T035	T035 Gas Relay 1 stuck open.
T046	T046 Number of Anodes Mismatch
T105	T105 Water Leak Sensor Not Installed
T113	T113 Flame Rod Degraded and Needs Servicing

ERROR CODES

Error Code	Display
T114	T114 Flame Rod Degraded and Needs Servicing
T115	T115 Combustion Health Degraded: Needs Service
T116	T116 Combustion Health Degraded. Needs Service
T117	T117 Time to Drain and Inspect Tank
T118	T118 Time to Check Venting for Debris
T119	T119 Time to Clean Out the Condensate Drain Trap
T120	T120 Time to Replace the Neutralizer
T121	T121 No water Detected in Tank
T122	T122 Powered Anode Control Comm Failure
T123	T123 Upper Anode Open
T125	T125 Upper Anode Shorted
T126	T126 Upper Anode Overload
T127	T127 Upper Anode Pre-Overload
T128	T128 Middle Anode Open
T130	T130 Middle Anode Shorted
T131	T131 Middle Anode Overload
T132	T132 Middle Anode Pre-Overload.
T133	T133 Lower Anode Open
T135	T135 Lower Anode Shorted
T136	T136 Lower Anode Overload
T137	T137 Lower Anode Pre-Overload
T140	T140 Anode 4 Shorted
T141	T141 Anode 4 Overload
T142	T142 Anode 4 Pre-Overload
T150	T150 Percentage of Successful Ignition is Low
T151	T151 Flame Current Deviation is High
T152	T152 Blower Motor Deviation is High
T504	T504 WiFi Chip Communication Error

TROUBLESHOOTING ERROR CODES

Error A001 Ignition Lockout

This unit has failed ignition 27 consecutive cycles. The unit will fail nine times and give an A029. It will fail 9 more times and give an A029. On the 27th failure, the unit will lock out with an A001 code.

The only visible check is to look through the sight glass window into the combustion chamber. The sight glass is located on the mounting plate next to the igniter and flame rod. ANY flame, no matter how long, means the igniter and gas valve are both operational.

CHECK FOR SPARK: Spark cannot be seen through the sight glass. When display shows “ignition” do you have flame? Yes – If flame is present then igniter does not need to be checked any further.

If No – To verify spark at igniter, turn gas off, remove igniter hang off side of unit so no metal is touching, leave wires connected, recycle heater and look for spark at igniter rods. If no spark is present, confirm the spark gap is approximately 3/16th at tip of rods. Clean igniter rods with an abrasive material such as emery cloth, steel wool, etc. and repeat check for spark. Cycle the unit back on and check for spark from board when the display showing “ignition”. If no spark is present from the board to the cable, replace the ignition control board. If spark is present from board to cable, replace the igniter assembly.

CHECK FOR WATER IN COMBUSTION CHAMBER: Remove igniter and flame rod, shine a light through one hole while looking through the other, or, remove only the igniter and use something (wire, copper tubing, a 1/2” tape measure will fit) to insert into the hole that will reach the bottom of the chamber (4ft deep or more). Insert till it stops, remove, is it wet? How many inches of the object is wet? Up to 6 inches of water could be a result of condensation forming from short cycling but all water must be removed for proper operation. Larger amounts of water may be suspect for tank leak.

INCORRECT GAS PRESSURE: See page 49 for instructions on checking gas pressure.

CHECK CONDENSATE DRAIN LINE: Condensate that is not draining properly will back up into the exhaust elbow, restricting the exhaust vent. Is the drain line configured per the Use & Care Manual? THERE SHOULD BE NO TRAP OR NEUTRALIZER KIT IN THE CONDENSATE RUN. Does condensate line maintain at least 1/4” per foot fall to drain? Runs that cannot maintain at least 1/4” per foot fall and/or are over 15ft in distance must utilize a condensate pump. If pump is being utilized, is it working?

CHECK VENTING: Are intake and exhaust vent runs within maximum allowances? Are there any horizontal runs that may be pitched incorrectly and holding water/debris to create restriction? Is exhaust vent pushed too far down into the grey exhaust tee? Venting should not go more than 2 inches into the tee.

VERIFY VENT TERMINATIONS: If concentric vent kits is being used, remove intake vent from heater and recycle. If no error occurs with intake removed then issue is with the concentric vent kit. Common issues are: kit connected with intake and

exhaust reversed, center pipe missing or loose, non-approved vent kit being used, equal ft not removed.

FLAME RECOGNITION: If the unit fires and goes out then the board does not sense flame. Confirm flame rod wire is secure at board and wire is not damaged. Turn unit off, remove and clean flame rod with an abrasive material such as emery cloth, steel wool, etc. If possible, measure flame current (minimum flame current for board to sense flame is 0.5uA). If minimum flame current is present and code continues, replace control board.

GAS VALVE ADJUSTMENT: MUST BE DONE WITH COMBUSTION ANALYZER. See page 50.

Gas Valve Checking Procedure

- Cycle power and/or clear any alarms on the display.
- Locate the large black wiring harness plugged into the top of the gas valve. Loosen the Phillips head screw at the top of the connector, then disconnect it from the gas valve.
- With connector removed, cycle the power on, while display is showing “IGNITION” check voltage across pins 1 & 5 in the connector. Voltage reading should be between 10-15VAC. If the voltage reading is correct then the gas valve is being supplied power and should be operating. If you do not get 10-15VAC then we could have a faulty gas valve harness or faulty control board.
- Is the gas valve working? The best way to confirm the gas valve is operating is with a manometer. Reconnect all wiring, and connect a manometer to the inlet port of the gas valve. Cycle power and check for a pressure drop when the unit goes to “IGNITION”. If you have ANY drop at all, the gas valve is opening and allowing gas flow. (See page 49 for instructions)
- If you do not have a manometer available, a less accurate check can be done. With all wiring reconnected, cycle power on and hold your hand on top of the gas valve solenoid, when the unit goes to “IGNITION” you should feel a noticeable click.
- If you do not get any pressure drop with a manometer and/or do not feel the solenoid click, replace the gas valve.

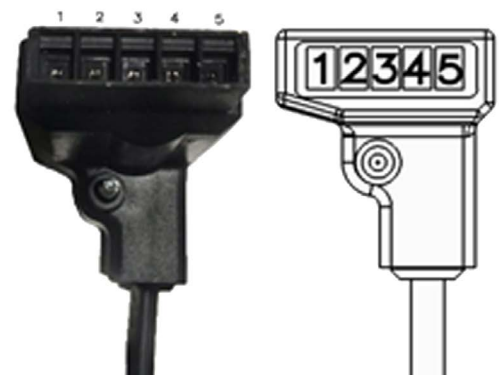

TROUBLESHOOTING ERROR CODES (TRITON SD)

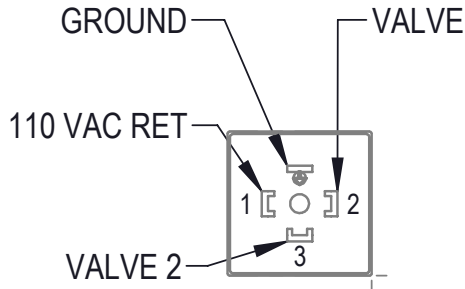

With connector removed, cycle the power on, while display is showing "IGNITION" check the voltage across pins Valve 1 and Ground and repeat and check across Valve 2 and Ground. Voltage reading should be ~120VAC. If the voltage is reading correct then the gas valve is being supplied power and should be operating. If you do not get ~120VAC then you could have a faulty gas valve harness, faulty relay, 24VAC harness, or control board.

Check relays across Com and NO (normally open) on both relays. During ignition it should show ~120VAC. If it does not the relay is faulty and needs to be replaced. When the not in ignition or heating the relay should not read a voltage or have continuity. The 24V side of the relays should only have voltage 24VAC during ignition and heating. Ensure all harnesses are properly wired.

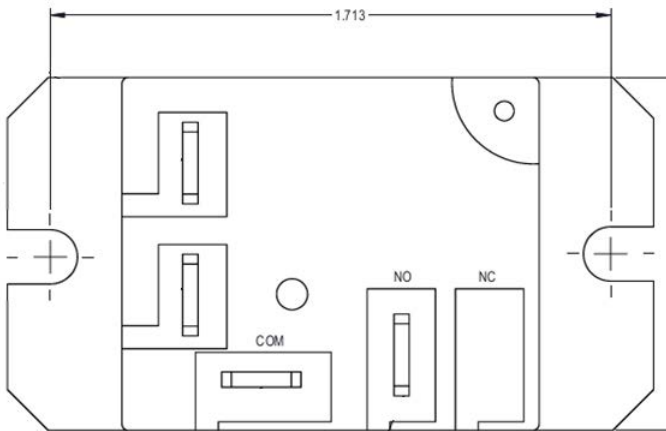
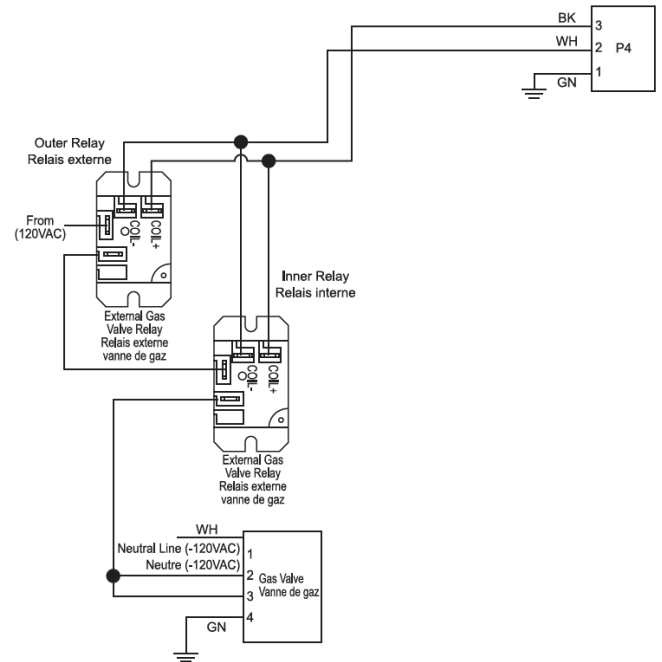

TROUBLESHOOTING ERROR CODES

Error A001 Ignition Lockout (continued)

Gas Valve Harness and Control Board Checks

- Trace the wire harness from the gas valve backwards to P4 connector on the ignition control board and Disconnect the Molex connector from the P4 connection.
- Cycle power and/or clear any alarms. When the display is showing "IGNITION", measure for 24V across the outside pins on the P4 connector.
- If you get the 24V, then the control board is operating correctly. Replace the gas valve wiring harness.
- If you do not get the 24V, replace the ignition control board.

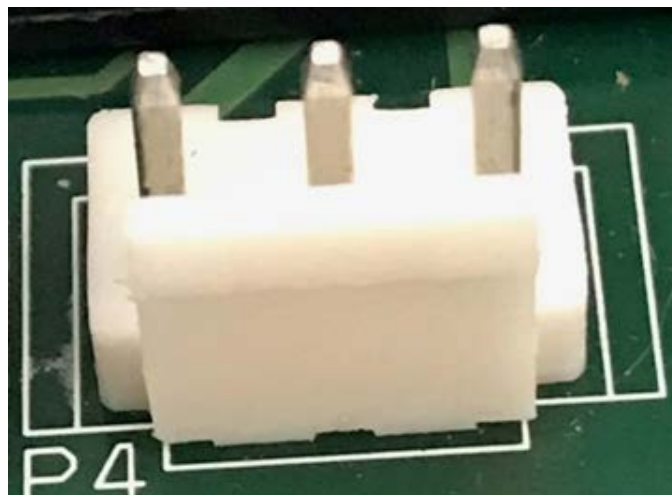

Error A002 Flame is Not Stable

This alarm code means the unit had flame rectification within one heating cycle; but lost the flame rectification signal three times within one call for heat. Causes of this issue are: Incorrect gas pressure or gas supply issues, incorrect vent terminations, restricted exhaust vent, dirty flame rod.

CHECK FOR WATER IN COMBUSTION CHAMBER:

Remove igniter and flame rod, shine a light through one hole while looking through the other, or, remove only the igniter and use something (wire, copper tubing, a 1/2" tape measure will fit) to insert into the hole that will reach the bottom of the chamber (4ft deep or more). Insert till it stops, remove, is it wet? How many inches of the object is wet? Up to 6 inches of water could be a result of condensation forming from short cycling but all water must be removed for proper operation. Larger amounts of water may be suspect for tank leak.

INCORRECT GAS PRESSURE: See page 49 for instructions on checking gas pressure.

CHECK CONDENSATE DRAIN LINE: Condensate that is not draining properly will back up into the exhaust elbow, restricting the exhaust vent. Is the drain line configured per the Use & Care

Manual? THERE SHOULD BE NO TRAP OR NEUTRALIZER KIT IN THE CONDENSATE RUN. Does condensate line maintain at least 1/4" per foot fall to drain? Runs that cannot maintain at least 1/4" per foot fall and/or are over 15ft in distance must utilize a condensate pump. If pump is being utilized, is it working?

CHECK VENTING: Are intake and exhaust vent runs within maximum allowances? Are there any horizontal runs that may be pitched incorrectly and holding water/debris to create restriction? Is exhaust vent pushed too far down into the grey exhaust tee? Venting should not go more than 2 inches into the tee.

VERIFY VENT TERMINATIONS: If concentric vent kit is being used, remove intake vent from heater and recycle. If no error occurs with intake removed then issue is with the concentric vent kit. Common issues are: kit connected with intake and exhaust reversed, center pipe missing or loose, non-approved vent kit being used.

CHECK GAS VALVE ADJUSTMENT: Should only be performed with a combustion analyzer. See page 49.

Error A003 Intake Switch Open

The intake pressure switch is a normally closed switch. It should only open if there is a blockage/restriction in the intake venting.

- Check wiring to the switch to ensure no wires have been broken, damaged or disconnected.
- Confirm tubing from switch to the air intake is properly connected not damaged and free of debris.
- With unit off, remove wires from intake switch and check for continuity. If continuity is not present, replace the intake switch.

TROUBLESHOOTING ERROR CODES

- If continuity is present, cycle power back on and clear alarm code. If switch opens (loses continuity) with blower running, then switch is operating normally and there is something causing vent restriction.
- Remove the air intake pipe from the rubber fernco connector at blower, if unit will fire with venting removed then issue is in venting.
- If error persists with intake removed from blower, verify no debris in blower housing. If no debris found and switch still opens with intake venting removed, replace the intake pressure switch.

Error A004 PoF Open During Heating

The Proof of Fan pressure switch is open during heating. You can clear this error code by pressing clear button on the current alarm screen. If problem persists a part replacement may be required.

- Check the following to see if the problem can be resolved.
- Check wiring to the pressure switch to ensure no wires have been broken, damaged or disconnected.
- Confirm tubing from switch to the blower mounting flange is properly connected, not damaged, and clear of debris.

- Confirm the rubber cap (if has second port) is covering the test port on the top of the pressure switch, if the cap is missing it will allow air pressure to escape and could result in alarm to occur.
- Check air intake for blockages and remove blockage if present.
- Check barb in collar is clear of debris and is not damaged.

You can clear this error code by pressing clear button on the current alarm screen. If problem persists, replace the PoF pressure switch.

Error A005 PoF Open During Pre-Purge

The Proof of Fan pressure switch is open during purge. The PoF switch is a normally open switch that closes from positive pressure from the blower.

- Check wiring to the switch to ensure no wires have been broken, damaged or disconnected.
- Confirm tubing from switch to the air intake is properly connected and not damaged.
- Confirm the rubber cap (if has second port) is covering the test port on top of the pressure switch, if the cap is missing it will allow air pressure to escape and could result in alarm to occur.
- Check air intake for blockages and remove blockage if present

- Remove air intake from blower, confirm no debris has been sucked into the blower housing.
- Clear the alarm and confirm blower is running when display status shows "Pre-Purge". If blower is not running during "Pre-Purge", replace the blower.
- Check continuity to see if switch is open while the blower is running. If switch does not have continuity while the blower is running then, replace PoF pressure switch.
- If switch has continuity while fan is running but alarm persists, a board replacement may be required.

Error A006 PoF Open During Post Purge

The Proof of Fan pressure switch is open during purge. Check the following to see if the problem can be resolved.

- Check wiring to the switch to ensure no wires have been broken, damaged or disconnected.
- Confirm tubing from switch to the air intake is properly connected and not damaged.

- Confirm the rubber cap (if has second port) is covering the test port on the top of the pressure switch, if the cap is missing it will allow air pressure to escape and could result in alarm to occur.
- Check air intake for blockages and remove blockage if present.

You can clear this error code by pressing clear button on the current alarm screen. If problem persists, replace the PoF pressure switch.

TROUBLESHOOTING ERROR CODES

Error A007 Exhaust Pressure Switch Open

The exhaust pressure switch is a normally closed switch. It will only open in the event of excess pressure in the exhaust venting. Check the following:

- Check wiring to the switch to ensure no wires have been broken, damaged or disconnected.
- Confirm tubing from switch to the air intake is properly connected and not damaged.
- With the unit off, check continuity on the pressure switch. If no continuity present, replace the exhaust pressure switch.
- Check exhaust vent for clogs and remove if present.
- Check for condensate backing up into exhaust tee.

You can clear this error code by pressing clear button on the current alarm screen. If problem persists a part replacement may be required.

Error A008 PoF/Blower Mismatch

The Proof of Fan pressure switch is closed when the blower is off. Check the following to see if the problem can be resolved.

- If the blower is running while, the alarm is present, follow troubleshooting for error A025.
- If the blower is not running, check to ensure the PoF switch has not been jumped. If not, check continuity to the switch. It should be open when the blower is off. If the switch is reading closed (has continuity) with the blower not running, replace the PoF switch.
- Clear the alarm and see if the A008 returns. If A008 returns and the pressure switch is reading open (no continuity), replace the ignition control board.

Error A010 End Of Line Test Failure

This error should never present on a unit in the field. If this error should occur, replace the ignition control board.

Error A016 Energy Cut Off Switch Is Open

The tank temperature has exceeded the allowable temperature.

- Confirm water in unit is not above 200°F.
- Inspect wiring and connections on both the upper temperature probe and control. If wiring is properly connected, try to clear alarm through display.
- If alarm does not clear, cycle power off, and check the ECO using a multi-meter. Disconnect wiring from ECO/Temp probe. Check for continuity across pins 3 & 4 of the probe. If no continuity found, replace ECO/Temp probe.
- If continuity is present through probe, reconnect wiring to ECO/Temp probe. Disconnect the P2 harness from the control board and check for continuity across the two orange wires. If no continuity is present through wiring, replace the wiring harness. If continuity is present through both the probe and wiring. Replace the control board.
- Replace ECO/Temp probe ONLY if it is OPEN but the display is reading a tank temperature of less than 200°F.

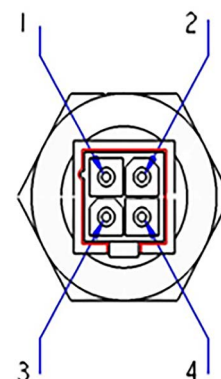

TROUBLESHOOTING ERROR CODES

Error A017 Flue High Flue Temp

This error code means the combustion gases at exhaust tee at the bottom of the tank are too hot. The sensor trips at 160°F and the alarm cannot be cleared until the sensor temperature is below 155°F . Things to check:

- Make sure the white wires are attached to the sensor.
- Check the PVC venting past the exhaust tee for signs of disfigurement and/or discoloration caused by heat.
- Make sure the Molex at location P2 Pins 1 and 2 on the control board is tight, all wires are secure, and the pins on the control board are not bent/broken.
- Disconnect the 2 white wires from the flue gas sensor and check the ohms reading across the two spade terminals on the sensor. Using the chart below, the temperature reading should be between ambient air temperature and no more than 160 degrees.
- If the ohms reading on sensor is within the required temperature range and the error will not clear, cycle power off



to the unit. Reconnect the white wire back the flue sensor. Disconnect the P2 harness from the control board and check the ohms reading across the white wires. The reading should be about the same as reading you got on the sensor spade terminal. If the readings do not coincide, replace the control wiring harness.

- If all reading on sensor and wiring check good, replace the ignition control board.
- If the sensor is reading open or outside of specified temperature range, wait 5 minutes and recheck. If sensor is still outside of range then replace sensor.
- If after five minute wait time the ohms reading for sensor is showing within specified temperature range, Call Tech Support at 1-800-432-8373.

Temp °C	Temp °F	Resistance (Ω)
0	32	36100
5	41	28590
10	50	22790
15	59	18290
20	68	14770
25	77	12000
30	86	9805

Temp °C	Temp °F	Resistance (Ω)
35	95	8055
40	104	6653
45	113	5524
50	122	4609
55	131	3863
60	140	3253
65	149	2752

Temp °C	Temp °F	Resistance (Ω)
70	158	2337
75	167	1994
80	176	1707
85	185	1467
90	194	1266
95	203	1096
100	212	952

Error A018 Flue Temp Sensor Open

This alarm means the control is sensing the flu temperature sensor as being open or disconnect.

- Refer to A017 for troubleshooting.

Error A019 Flue Temp Sensor Shorted

This alarm means the control board is sensing a short in the flue temperature sensor or wiring harness.

- Refer to A017 for troubleshooting

TROUBLESHOOTING ERROR CODES

Error A022 Upper Tank Sensor is Open

This error code means the water temperature probe is not connected or the water temperature thermistor is damaged. Things to check:

- Make sure the Molex connector to the ECO/temperature probe is connected, harness is properly oriented so locking tab on Molex locks into ECO/temp probe, and wires are secure.
- Make sure the Molex at location P2 on the ignition control board is securely connected and oriented so the locking tab on the Molex locks onto the connector on the control board. Confirm all wires are secure in the harness, and the pins on the control board are not bent/broken.
- Disconnect wiring from the ECO/Temp probe. Check the ohms reading across pins 1 & 2, as shown in the photo to the right, and compare to the chart below.

The resistance should show about what the water temperature is inside the tank. Replace the temp probe if the circuit is open or the resistance value does not represent the water temperature in the tank.

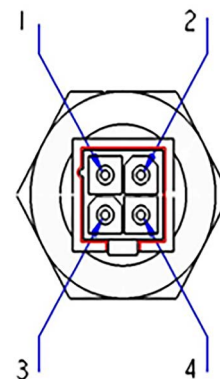

- If ECO/Temp probe reading is correct, reconnect wiring to ECO/Temp probe. Disconnect the P2 wiring harness from the control board and measure the ohms reading across the blue wires in the harness. You should get about the same ohms reading as you had on the probe. If the reading is not close or circuit reads open, replace the wiring harness.
- If all readings are correct at probe and harness, replace the ignition control board.

Temp °C	Temp °F	Resistance (Ω)
0	32	36100
5	41	28590
10	50	22790
15	59	18290
20	68	14770
25	77	12000
30	86	9805

Temp °C	Temp °F	Resistance (Ω)
35	95	8055
40	104	6653
45	113	5524
50	122	4609
55	131	3863
60	140	3253
65	149	2752

Temp °C	Temp °F	Resistance (Ω)
70	158	2337
75	167	1994
80	176	1707
85	185	1467
90	194	1266
95	203	1096
100	212	952

A023 Upper Tank Temp Too Hot

This alarm means the ignition control board is sensing the upper tank temperature has exceeded 205°F. The programming on the control board should not allow this to happen and therefore we are dealing with either a bad ignition board, ECO/Temp Probe, or wiring harness.

- Refer to troubleshooting steps for A022.

TROUBLESHOOTING ERROR CODES

Error A024 Upper Tank Sensor Shorted

The control board is detecting a short in the ECO/temperature probe or wiring.

- Refer to troubleshooting steps for A022.
-

Error A025 No Blower RPM Feedback

Control does not detect blower RPM. This is typically caused by a bad blower or wiring harness being disconnected.

- If the blower is running while this error is present, confirm disconnect and reconnect both wiring harnesses from the blower and make sure wiring harness from blower to board is secure at board. If blower continues to run with error present, replace the blower.
 - If blower is not running, clear the alarm and see if blower comes on. If the blower does not come on, disconnect the wiring harness with black, white, red, and blue wires from blower. With the power turned on to the unit and this harness disconnected, the blower should run at full speed. If blower still does not come on or will only run at a very low speed then replace the blower.
-

Error T026 Blower Expected RPM vs Actual RPM mismatch

Control board detects blower running at ≥ 300 RPM from desired RPM for > 1 minute.

- Confirm wiring harness from control board to fan is secured at both ends and all wires are secure in the Molex connectors.
 - Cycle power and clear alarm. If issue remains replace the blower.
-

Error A027 Flame Present Before Ignition

This error code means that a flame was detected prior to ignition or the controller was detecting flame rectification before the gas valve was open. You can clear this error code by turning the unit off and on.

Things to check:

- Check for flame through the sight glass. If flame is present with this code, either the gas valve needs to be replaced or gas pressure to unit is above maximum stated on rating label.
- Make sure the heater has a solid earth ground at the electrical connection box on top of the unit; and the electrical connection to the power supply has a solid earth ground.
- Shut off the gas supply and cycle the water heater. If the error code returns, then replace the controller.

TROUBLESHOOTING ERROR CODES

Error A028 Flame Present W/O Heating

This alarm means the control board detected a flame signal 10 seconds after the gas valve had closed from the last heating cycle.

- Check for flame through the sight glass. If flame is present with this code, either the gas valve needs to be replaced or gas pressure to unit is above maximum stated on rating label.
- Make sure the heater has a solid earth ground at the electrical connection box on top of the unit; and the electrical connection to the power supply has a solid earth ground.
- Remove and clean the igniter and flame rod then reinstall. Allow the unit to go through a heating cycle to see if the error occurs again. If error occurs and no flame is visible through the sight glass, replace the flame rod.

If flame rod is replaced and error continues, replace the ignition control board.

IF GHE119

- Check relays with unit in standby to confirm continuity is not present, relays are normally open. If present replace relay.
- If not found replace both relays and confirm unit operates normally.

Error T029 Failed Ignition

The unit will fail nine times and give an A029. It will fail 9 more times and give an A029. On the 27th failure, the unit will lock out with an A001 code.

- Refer to Error A001 for troubleshooting. (See Page 33)

Error A030 Flame Lost During Heating

This code means the unit lost flame signal during heating. The unit will attempt to heat 3 times in 3 consecutive cycles. After the 3rd try, the unit will lock out with a code A002.

- Refer to Error Code A002 for troubleshooting.

Error A031 Loss of Anode Communication

This error code means there is a loss of Anode communication. This will not disable the water heater or keep it from heating.

- Check the connections between anode control and ignition control.
- Check the harness for proper connections.
- If error code is still present, replace the anode control
- If error is still present after replacement, replace the ignition control board.

TROUBLESHOOTING ERROR CODES

Error A033 through A043 Relay/Communication Errors

All of these codes are related to ignition control failure.

- Cycle power and attempt to clear alarm. If alarm does not clear, replace ignition control board.

Error A044 Processor Clock/Line Frequency Disagree

If power line frequency is below 45 Hz or above 65 Hz for more than 5 seconds the control issues a fault code and cancels demand for heat. Operation resumes and fault clears when power line frequency returns within the range of 47 to 63Hz.

- Cycle power and attempt to clear alarm.
- If alarm does not clear, have electrician verify power supply Hertz rate is within the required 45-65 Hz range.

Error A101 Configuration Data Restore

- Cycle power and attempt to clear alarm. If alarm does not clear, replace display control.

Error A102 Time Clock Needs to be Programmed

- Go to configurations and set the time and date.

Error A103 Time Clock Not Advancing Time Properly

- Cycle power and attempt to clear alarm. If alarm does not clear, replace display control.

Error A104 Water Leak Detected

The presence of water has been detected by the control. Make sure that the water heater doesn't shut down without interactions from the customer and perform the following checks:

- Visually inspect the unit for leaks.
- If no leaks are detected, check water leak sensor for water.
- If sensor is not wet, replace leak sensor or control if leak sensor has already been replaced.
- If sensor is wet, proceed to steps for leak resolution.

Error A108 Ignition Board Communication Failure

Communication lost between the display board and the ignition control board. The ignition control board will continue to operate the heater using the last known configuration settings.

- Check wiring between the display and P5 of the ignition control board.
- If all wiring is secure and undamaged, replace ignition control board and/or display.

TROUBLESHOOTING ERROR CODES

Error A109 External CO Sensor Alarm

CO sensor detects carbon monoxide above the threshold limit. The unit does not come with a CO sensor. If the unit does not have one wired directly to it then the configuration setup could be causing a false alarm.

- If there is an auxiliary CO Sensor connected to the unit, follow the sensor manufacturer's instructions for checking proper operation of the sensor.
- Confirm there are no exhaust leaks from loose vent connections,
- From the front display tap the "Settings" button. Then tap "configs". From the "config. settings" screen make sure the auxiliary input select is set to "Flow Sensor". If this setting is "CO Sensor" with no sensor connect, it can produce a phantom A109 code.

Error A110 & A111 Shut-off Valve Monthly Test Close/Open Error

These codes indicate that the monthly test of the automatic shut off valve (premium models only) was not completed properly. The valve did not close in the allotted time. Every 30 days, the unit shuts the valve and opens it. If it doesn't see shut indication, these error codes will occur.

- Drain the tank and remove the automatic shutoff valve. Clean any debris from inside valve body and manually rotate the ball valve to ensure the motor is not seized up.
- Reinstall the valve, fill the tank with water, and clear the alarm. If issue persists replace the automatic shutoff valve.
- You can manually open and close the valve if the drive motor has failed.

Error A112 Shutoff Valve Not Open

- Confirm the Molex connectors from valve to water heater wiring is securely connected.
- Confirm no wires are loose/damaged in Molex connectors from valve to water heater.
- Manually open the shutoff valve, clear the alarm. If the alarm persists, replace the automatic shutoff valve.

TROUBLESHOOTING ERROR CODES

Error T020 Lower Tank Sensor Open

Control senses the lower tank temperature sensor open. This will not disable the unit or keep it from heating water. The alert will clear on its own when the issue is resolved.

- Confirm wiring harness is securely connected to lower tank temperature sensor and confirm the wiring harness at the P2 connection on the control board is secure.
- If no wiring is loose, disconnect wiring from lower temperature probe. Check ohms reading across the pins of the sensor. A good sensor should read between 1K to 36K ohms. If sensor reads open, replace the sensor.
- If sensor has a reading between 1K to 36K ohms, reconnecting the wiring to the sensor. Turn off power and disconnect P2 harness from ignition control board and check the ohms reading across the 2 blue wires. Your reading should be about the same as the reading you got on the sensor. If not, replace the wiring harness. If readings match and error won't clear then replace the ignition control board.

Error T021 Lower Tank Sensor Shorted

The control board is detecting a short in the lower temperature probe wiring. This will not disable the unit or keep it from heating water.

- Disconnect the wiring from lower temperature probe. If unit gives an alarm for T020, replace the lower temperature probe.
- If you do not get the T020, turn the unit off. Disconnect the lower temperature probe wiring and the P2 harness at the ignition control board and check for continuity across the wires at the lower temperature probe. If you have continuity, there is a short in the wiring harness. Replace the wiring harness.
- If above checks determined no resolution, replace the ignition control board.

Error T029 Failed Ignition. Retrying

The unit will fail nine times and give an A029. It will fail 9 more times and give an A029. On the 27th failure, the unit will lock out with an A001 code.

- Refer to Error A001 for troubleshooting. (See Page 33)

Error T032 Lower Tank Temp A/D Error

The control board cannot convert the analog reading from sensor to digital reading to the display. This will not disable the unit or keep it from heating water.

- Cycle power. If issue remains, replace the ignition control board.

Error T105 Water Leak Sensor Not Installed

- Check wiring for proper connection from wiring harness to control board, ensuring wiring is not damaged (4 wire, 2 blue/2 black)
- If wiring is properly connected, disconnect from wiring harness and check continuity across bottom terminals (If leads are too large, use a smaller metal item such as a paper clip to check for continuity(right)). The top terminals will only have continuity if the sensor is wet, which will cause an additional error code.
- If there is no continuity (open circuit) replace leak sensor.

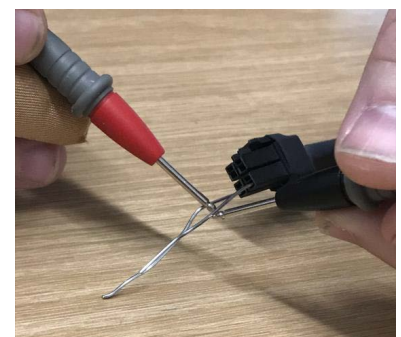

TROUBLESHOOTING ERROR CODES

Error T113 & T114 Flame Rod Degraded

These alerts indicate the peak flame current reading has substantially decreased from the initial startup of the unit. This is indicative of a dirty flame rod and/or ignition/flame failures. These alerts will not keep the unit from heating nor can they be manually cleared.

- Remove and clean the flame rod with an abrasive material such as emery cloth, steel wool, etc.
- Allow at least 10 heating cycles for the unit to recognize the issue has been resolved and it will clear this alert on its own.
- If alert does not go away on its own, check alarm history for other Alarms/Alerts and troubleshoot based on those alarms.

Error T115 & T116 Combustion Health Degraded

These alerts cannot be manually cleared and are the result of periodic failed ignitions, flame loss, pressure switches errors during heating cycles, etc.

- Check alarm history for any codes regarding pressure switches, failed ignitions, etc. Refer to troubleshooting for those alarms/alerts.
- If the only thing in the history is the T115/T116 codes then someone has tried to clear the alarm so many times that it has erased any previous history. Best option is to let the unit operate for a full day without attempt to clear the T115/T116 alerts, then check the alarm history the next day.

Error T117 through T120 Periodic Maintenance

All of these alerts regard routine maintenance. When you clear the alarm(s) the timer for the maintenance alert will automatically reset. Things to check during routine maintenance are the following:

- Drain the tank and clean/remove any build up or debris through the hand hole cleanout.
- Routine check of the venting to ensure no debris or buildup in vent runs.
- Routine inspection of condensate line to ensure neutralizer rocks have not been depleted, no debris buildup in exhaust tee, no clogs or debris in the condensate line.

Error T122 No Communication with Powered Anode Controller for >60 seconds.

Locate the anode control module at the top of the unit. If the LED light on top of the module is GREEN then the anodes are still protecting the tank.

- Confirm both wiring harnesses are securely connected to anode control module and no signs of damage to wiring.
- If both harnesses are secure and LED on anode module is not green, anode module needs to be replaced.
- If anode module LED is green, confirm wiring harness at the P8 connector on ignition board is secure and no signs of damage. If this checks good, cycle power. If issue persists replace ignition control board.



TROUBLESHOOTING ERROR CODES

T123 thru T 137 Anode Alerts

Anode locations indicated below. Refer to next 2 pages for troubleshooting instructions

GHE80SS, GHE80SU, GHE100SS, GHE100SU



GHE119SS, GHE119SU



TROUBLESHOOTING ERROR CODES

- If you are getting any error code regarding anode(s), the first step is to disconnect anode rod power wire from the UPPER, MIDDLE, or LOWER (dependent on the alert(s) given) anode(s) as shown in the photo to the right. NOTE: Leave water heater powered on.
- With anode rod power wire disconnected, the display should give an alarm of A121 or A123. If neither of these codes occurs after disconnecting the anode power wire, replace the anode control module.
- If either the A121 or A123 code appear after disconnecting the anode power lead, the next step is to make sure the retainer nut for the spade terminal connector is tightened down securely. Once secure, reconnect wiring, clear alarm and see if issue is resolved.

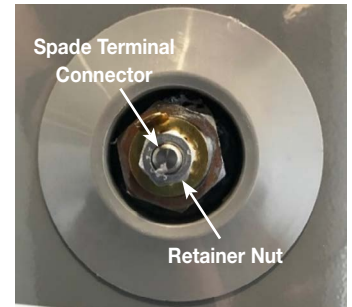
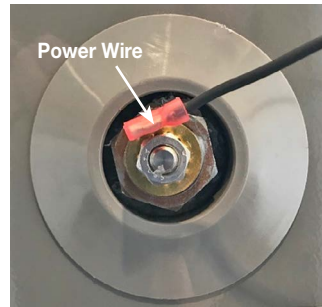

If issue persists, proceed to next page.

(Refer to next page for troubleshooting instructions).

NOTE- To check the anode rod, turn off power to the water heater.

- With power wire lead removed from anode, check for ohms reading by putting one meter lead to center stud of anode and the other meter lead to the hex head of the anode as show in the photos to the right.
- When checking the anode, you will need to do the ohms checking using both “polarities”. As shown to the right, check with black to stud and red to hex nut, then swap meter lead connection points and perform the check again.
- Ohms should only be sensed via one of the polarity tests. The other polarity should show no ohms (OL). If you get no resistance (“OL” reading) or ohms resistance on both polarities, replace the anode.

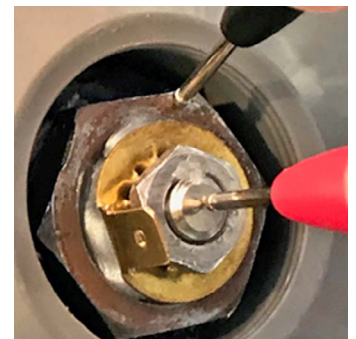

NOTE- Meter should be set on a range between 200K to 600K. Test is not accurate when meter is set to check Mega ohms (MΩ).

If no issue found with anode, proceed to next steps.

TROUBLESHOOTING ERROR CODES

NOTE- Turn off power to water heater.

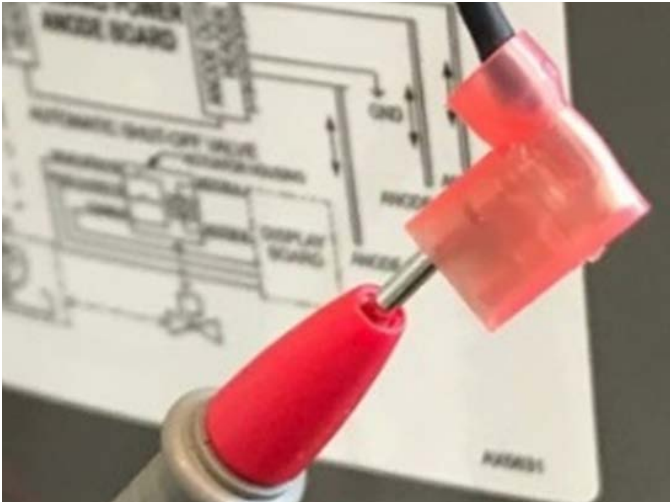

- With anode power wire disconnected, insert one meter lead into the wire as shown.



- Locate the anode control module.

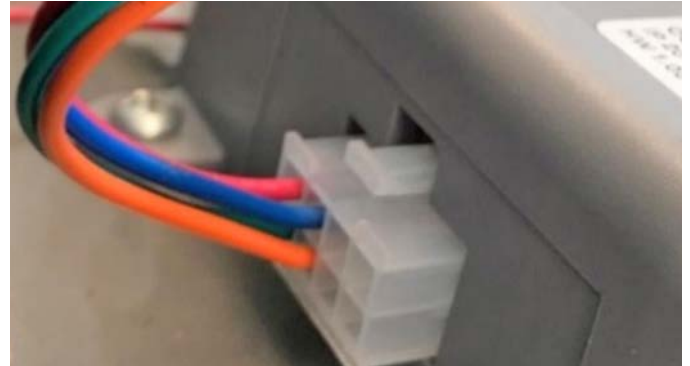

- Disconnect the anode power lead harness from the anode control module.

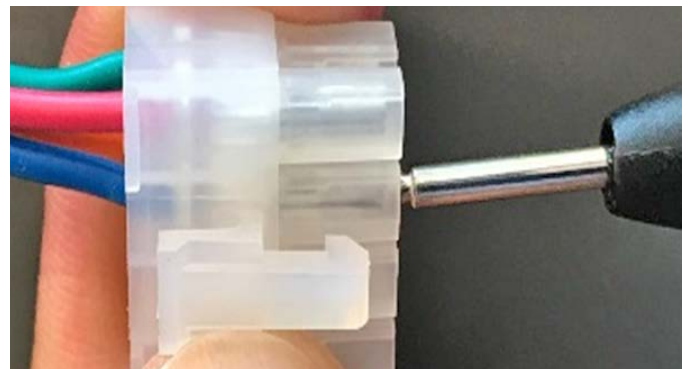

- Insert your other meter lead into the molex connector location for the wire associated with the suspect anode as shown in bottom photo.
- Resistance reading should be less than 20 ohms. If reading is higher than 20 ohms replace wiring harness.

NOTE- The anode rod power wire harness has 4 wires in the molex.

TRITON HD

GREEN = GROUND

RED = UPPER ANODE

BLUE = MIDDLE ANODE

ORANGE = LOWER ANODE

TRITON SD

GREEN = GROUND

YELLOW = UPPER

GRAY = MIDDLE

RED = 4TH

BLUE = LOWER

GAS PRESSURE CHECKING PROCEDURES

Gas Pressure Checking Procedure Triton HD

The Triton water heaters use a negative pressure gas valve so we do not check the manifold gas pressure. Our only checks are to confirm the inlet gas pressure is within minimum and maximum limits and verify the inlet pressure does not have more than a 1.5" w.c.

- Turn off the gas supply to the unit.
- Loosen the inlet pressure port screw on the valve about 1.5 turns. DO NOT REMOVE THE SCREW. (Inlet pressure port is labeled as "IN" See photos below)
- Attach a manometer to the inlet side of the gas valve.
- Turn gas supply back on and read the pressure while the heater is turned off. Confirm the pressure is within 3.5" – 10.5" w.c. for natural gas, 11.0" – 13.0" w.c. for LP.
- Turn the heater on, and wait for "Ignition" on the display. Any pressure drop at all confirms the gas valve has opened and is operating.
- During the "Ignition" and/or "Heating" status, if the pressure drops more than 1.5" w.c. from step #2, then you do not have enough gas flow to the heater. An adjustment to the piping system may need to be evaluated. If the Inlet pressure does not drop more than 1.5" w.c. from step #2, then you have sufficient gas flow and gas pressure.

400KBTU GAS VALVE



130 K - 300KBTU GAS VALVE



Gas pressure checking procedure SD

- Turn off gas supply to the unit.
- Using a 3mm Allen Head wrench remove the plug shown circled below.



- In the installation kit locate the extra barb included. (note the barb is not standard thread. The barb thread is BSPT). Use a 1/2" wrench to tighten.

GAS PRESSURE CHECKING PROCEDURES



- Attach a manometer to the barb on the side of the gas valve.
- Turn gas supply back on and read the pressure while the heater is turned off. Confirm the pressure is within 3.5"-10.5" w.c. for natural gas, 11.0"-13.0" w.c. for LP.

- Turn the heater on, and waiting for the "Ignition" on the display. Any pressure drop at all confirms the gas valve has opened and is operating.
- During "Ignition" and/or "Heating" status, if the pressure drops more than 1.5" w.c. from step #2 then you do not have enough gas flow to the heater. An adjustment to the piping system may need to be evaluated. If the inlet pressure does not drop more than 1.5" w.c. from step #2, then you have sufficient gas flow and gas pressure.



- Replace the plug in reverse steps after checking pressure.

Gas Valve Adjustment Procedure Triton (HD)

LOCATED ON PAGE 53

1. Turn Triton OFF.
2. Locate the adjusting screw on the gas valve. (See pics below for reference)
3. Turn the Triton ON and demand heat.
4. If the unit does not go to main burner, turn unit OFF; turn the screw counterclockwise a 1/8 turn and restart the unit.
5. Continue this procedure until you have main burner; and the LCD says HEATING.

Next, you will need a combustion analyzer for CO₂ to fine tune the gas valve.

6. Following the instructions on your combustion analyzer, get a reading of the CO₂ levels of the combustion gases. Easiest way to do this is to remove the pressure switch tubing from the exhaust pressure switch after the unit has been in "HEATING" status for at least 30 seconds. Insert your analyzer sensor into pressure switch tubing and check your CO₂ readings.
7. Once you have a consistent CO₂ reading, we need to adjust the reading to 8.8-9.2% CO₂ (10.3-10.8% for LP gas) If your reading is higher than 9.2%, then adjust the screw clockwise (-); if your reading is lower than 8.8%, then adjust the screw counterclockwise (+).
8. When final adjustments are complete, close and seal the tap hole.
 - All adjustments must be done with a minimum 15 degree delta T (difference between actual tank temp and set temp) to ensure heater is in full fire mode.
 - Excess gas valve adjustment will cause a cracked condensate pan. This will cause the heater to be replaced. Adjustments to the gas valve should be slow in 1/8 turn increments only.

400KBTU ADJUSTMENT SCREW (REQUIRES ALLEN HEAD WRENCH TO ADJUST)



130 TO 350KBTU ADJUSTMENT SCREW (REQUIRES FLAT HEAD SCREW DRIVER/WRENCH TO ADJUST)



GAS PRESSURE CHECKING PROCEDURES

Gas Valve Adjustment Procedure Triton (SD)

Inside the Service Menu, there is a button to make gas valve adjustments.

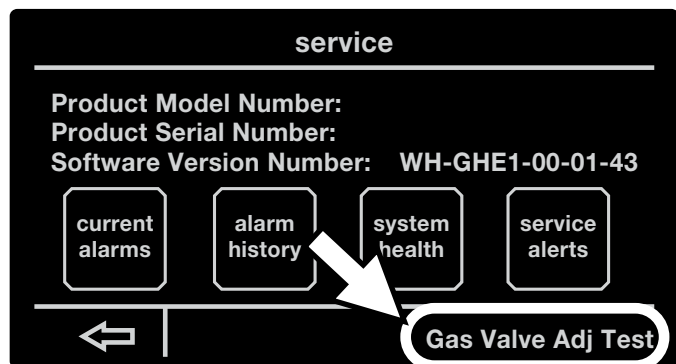

Pressing the "Gas Valve Adj Test" button will change the screen to the Test Screen. Confirm the conditions are met.

Press the "Start Test" button to begin the test.

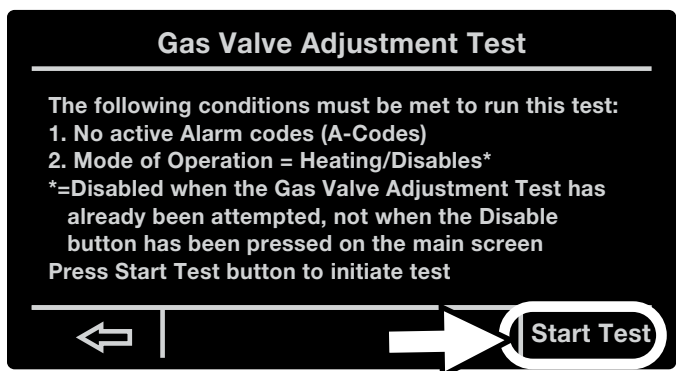

Once the test is started, the screen will show an initial "Awaiting Response" message with a countdown timer.

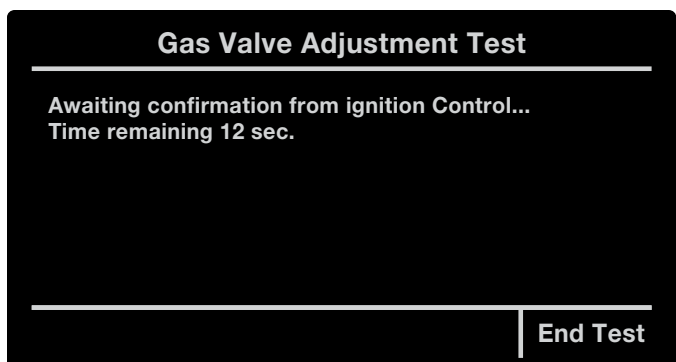

If the Ignition Control cannot respond, the test will be ended, and the screen will back out to the Service Screen for the test to be restarted from the beginning.

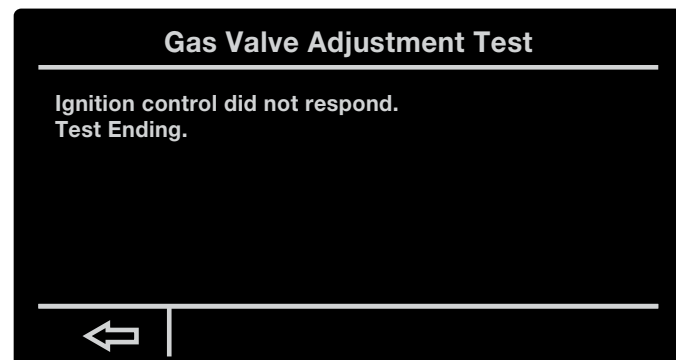

After a response from Ignition Control is made, the screen will transition to the "Running" Screen. The timer will be set to 10 minutes and begin to countdown. The tank temperature and fan speed will be displayed.

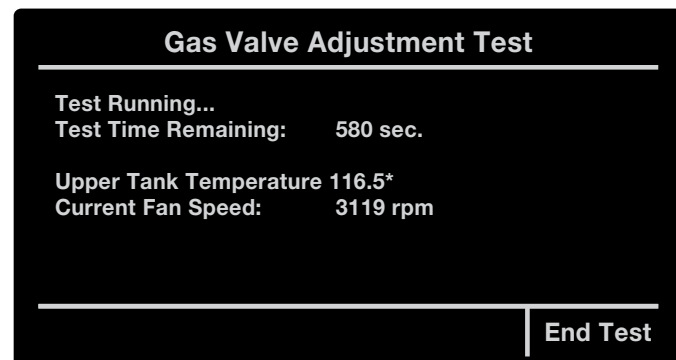

Connect CO2 analyzer. After sample is collected and is a suitable reading, adjust the gas valve by turning the offset in the appropriate direction. Use a 2.5mm (3/32") hex head tool to adjust the gas valve offset.

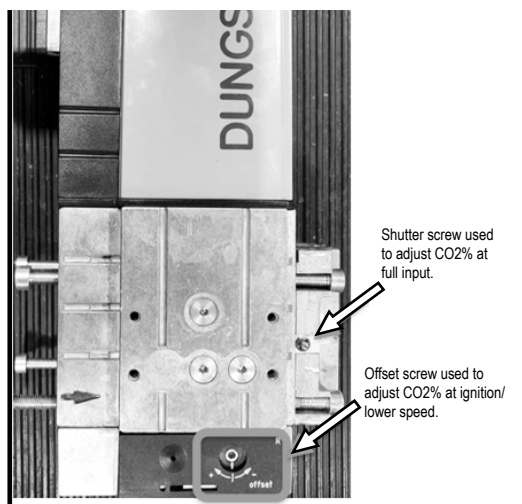

GAS PRESSURE CHECKING PROCEDURES

NOTE: To correctly adjust the offset screw, turn the hex head tool ½ turn in the desired direction and then back ¼ turn. This counts as a ¼ turn and ensures the offset screw adjusts properly. Adjust in this ¼ pattern until the target CO2% is reached.



Detailed view of offset adjustment screw.

The target CO2% level depends on fuel used in the system and can be seen in the table below.

Fuel Type	Target Low Fire CO2% (~O2%)	Target High Fire CO2% (~O2%)
Natural Gas	10-10.8% (~2.4-3.8%)	9% (~5.5%)
Propane	12-12.8% (~1.8-3%)	11% (~4.5%)

NOTE: Venting configurations and elevation directly affect CO2% levels in the system and may require richer (higher CO2%) at low fire/ignition.

Upon completing any necessary gas valve adjustments, press the “End Test” button to complete the test, else the test will continue until the timer expires.

If the duration timer expires during the test, the test timed out, and a message will appear on the screen. The Ignition Control will transition to Post-Purge before Disabling, and then the test will end.

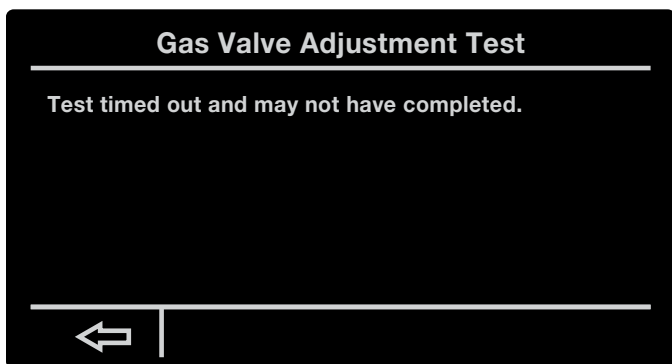

Press the back arrow to exit to the service menu.

If, during the gas valve adjustment test, the tank temperature exceeds that of the setpoint temperature, the test will end. The unit will go into Post-Purge and a “Heating Cycle Completed” message will appear on the screen.

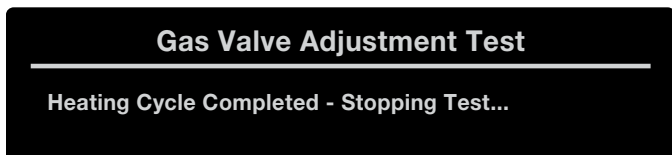

Once the Post-Purge is completed, the “Test Completed” message will appear on the screen.

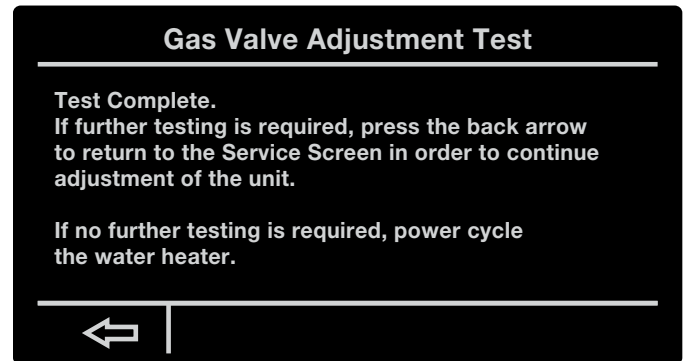

Press the back arrow to back out of the Test Screen and go to the Service Screen.

If the ignition control reads “Fault” or “Disabled,” the test will end, and the corresponding message will appear.

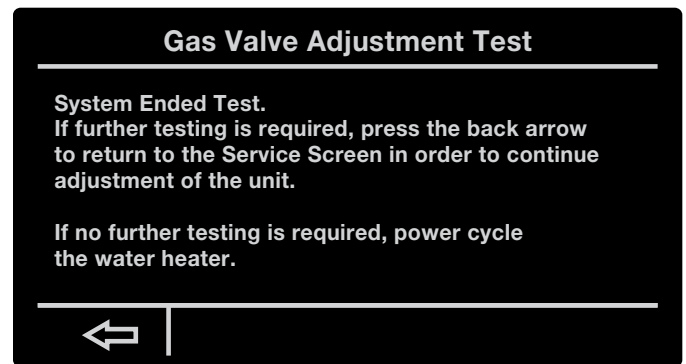

Press the back arrow to go back to the Service Screen to continue the test, or power cycle the water heater if finished.

If the “End Test” button is pressed while the test is running, the test will stop, and the corresponding message will appear.

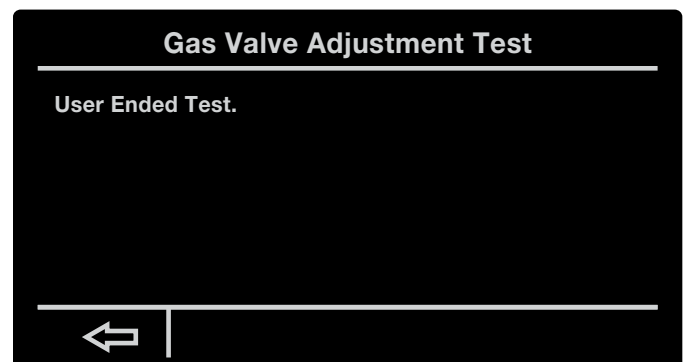

The Ignition Control will transition to Disabled, back out of the Test Screen to go back to the Service Screen.

TRITON DISASSEMBLY AND REPAIR

On the next few pages we have included instructions for replacing most repair parts on the Triton water heater. To further aid in the repair process we have also created some repair videos that can be accessed through the hyperlinks below.

Links are active in PDF Documents. If you have received this document as a paper copy, videos can be found by visiting Rheem's YouTube channel at www.youtube.com/RheemMFG.

Below is a list of currently available servicing video links with step by step walkthroughs of replacing each part.



**REPLACING THE
BURNER ASSEMBLY**



**REPLACING THE GAS
PRESSURE SWITCH**



**REPLACING THE
IGNITOR**



**REPLACING THE POF
PRESSURE SWITCH**



**REPLACING THE
FLAME SENSOR**



**REPLACING THE GAS
VALVE ASSEMBLY**

NOTE: When setting the CO₂ of either Triton 80, 100, or 120 gallon units. It is best to start with a cold tank if possible. Also recommended have water taps open to have water demand on the unit to extend time while setting the CO₂. Combustion analyzer is able to be connected to unit after the unit has ignited and fan speed has ramped up. This helps prevent unburnt gas from the ignition from extending the reading time.

DISASSEMBLY AND REPAIR

Ignition Control Board

1. Disconnect power to the water heater.
2. Remove all Molex connections to the control board. Wires are colored and the board locations have numbers to reconnect. See Wiring Diagram on page 9 of this document.
3. Remove the three Phillips screws holding the control board to the top of the water.
4. Remove the control and replace in reverse order.



Blower Motor

1. Disconnect power to the water heater.
2. Disconnect the 2 Molex connections.
3. Remove the two Phillips screws holding gas valve and venturi assembly blower motor.
4. Remove the 4 Phillips screws holding the blower the burner mounting flange.
5. Remove the blower and gasket from the burner mounting flange.
6. Replace parts in the reverse order making sure to use the new gaskets supplied with the blower. (There is a gasket for the blower/burner mounting flange and another gasket for where the gas valve and venturi assembly meets the blower.)

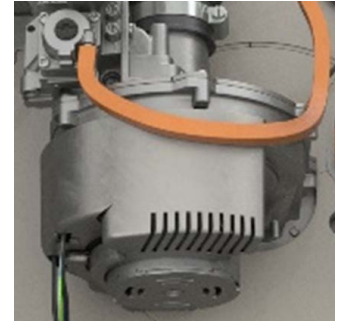

LCD Display



1. Disconnect power to the water heater.
2. Disconnect the three Molex connections. One goes to the ignition control board. The other 2 pigtail to other wiring harness.
3. Remove the two Phillips screws holding the display assembly to the top of the water.
4. Remove the display assembly and replace in reverse order.

Water Temperature Sensor

1. Disconnect power to the water heater.
2. Drain the water in the tank to a point below the level of the water temp sensor.
3. Remove all wiring connections to the sensor assembly.
4. Remove the sensor assembly with a wrench.
5. Replace in reverse order.



DISASSEMBLY AND REPAIR

Igniter



1. Disconnect power to the water heater.
2. Remove the green grounding wire.
3. Remove the two Phillips screws.
4. Remove the igniter assembly. You may need a small putty knife to get it started.
5. Clean all old gasket material from burner assembly.
6. Replace igniter in reverse order.

Flame Sensor

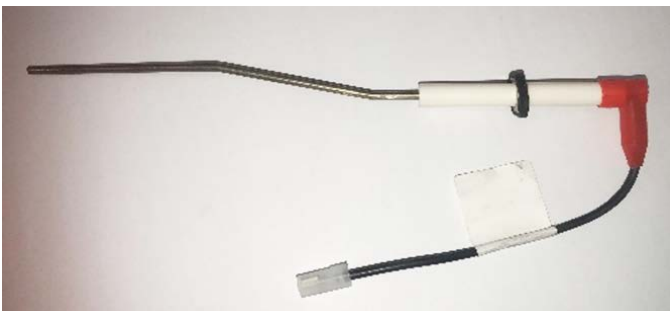

1. Disconnect power to the water heater.
2. Disconnect cable from control board.
3. Remove the two Phillips screws.
4. Remove the flame rod. You may need a small putty knife to get it started.
5. Clean all old gasket material from the burner assembly.
6. Replace in reverse order.

Pressure Switches

1. Disconnect power to the water heater.
2. Remove all wiring connections and rubber tubing to the pressure switch.
3. Remove the Phillips screw holding the pressure switch assembly in place.
4. Replace in reverse order.



Exhaust Gas Temperature Sensor

1. Disconnect power to the water heater.
2. Remove the white wires from the exhaust gas sensor.
3. Remove the sensor using a wrench.
4. Replace in reverse order.



DISASSEMBLY AND REPAIR

Replacing a Burner (Triton HD)

The only tools necessary for this will be a ratchet with a ½ in. socket and a #2 Phillips head screwdriver. Please consult the Use and Care manual before performing any changes and be sure to follow any safety messages in the manuals and on the appliance. Always ensure the customer has read and obey all safety messages.

1. Remove the hose from the gas valve and from the bottom of the blower.
2. Disconnect the leads to the igniter and to the flame rod sensor, as well as the ground.
3. Undo the two harnesses from the blower
4. Disconnect the two leads connected to the low gas pressure switch and remove the cable harness from the top of the gas valve using the Phillips head screwdriver.
5. Using the ratchet, remove the 5 bolts attaching the burner assembly to the top of the water heater.
6. Once the Bolts are removed, remove the entire burner assembly.
7. You will now have to remove the blower from the burner by using the Phillips head screwdriver to remove the four screws.



8. Remove 4 Phillips screws from collar. Remove old burner and the gasket.



9. To replace the burner aligning the notch, take the new burner and gasket and attach using the screws provided.



10. Make sure to attach the blower to the burner in the same orientation as it had been attached previously.
11. Insert the burner assembly back into the top of the water heater making sure that the air intake and the gas valve are pointing towards the back.



12. Bolt the burner assembly back into place and make sure to tighten all of the bolts using the ratchet and half inch socket.



13. Reconnect the ground to the igniter and reconnect the lead to the control box



DISASSEMBLY AND REPAIR

14. Reconnect the lead from the flame rod sensor to the control box.



15. Reconnect the two leads to the low gas pressure. (It does not matter which lead is connected to which tab.)

16. Reconnect the two harnesses to the front of the blower.



17. Reattach the cable harness to the top of the valve and secure it with the screw.



18. Reattach the intake hose to the front of the gas valve and the POF switch to the bottom of the blower.

DISASSEMBLY AND REPAIR

Replacing a Burner (Triton SD)

The only tools necessary for this will be a ratchet with a 1/2" socket (a 1/2" ratcheting wrench is best), a 5mm Allen head, and a #2 Philips head screwdriver. Please consult the Use and Care manual before performing any changes to be sure to follow any safety messages in the manuals and on the appliance. Always ensure the customer has read and obey all safety messages.

1. Remove the hoses from the gas valve and from the bottom of the blower.
2. Disconnect the leads to the ignitor and to the flame rod sensor from the control box, as well as the ground from the ignitor.
3. Undo the two harnesses from the blower.
4. Disconnect the two leads connected to the low gas pressure switch and remove the cable harness from the back of the gas valve using the Philips head screwdriver.

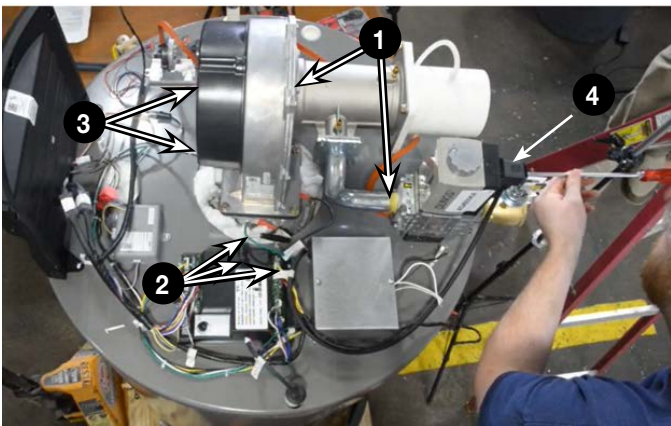

5. Using the ratchet, remove the 4 bolts attaching the blower assembly to the top of the blower collar.
 - 5a. To reduce the weight the valve and be removed by removing two of the 5mm allen head bolts on one side and loosen the other two to remove the valve.

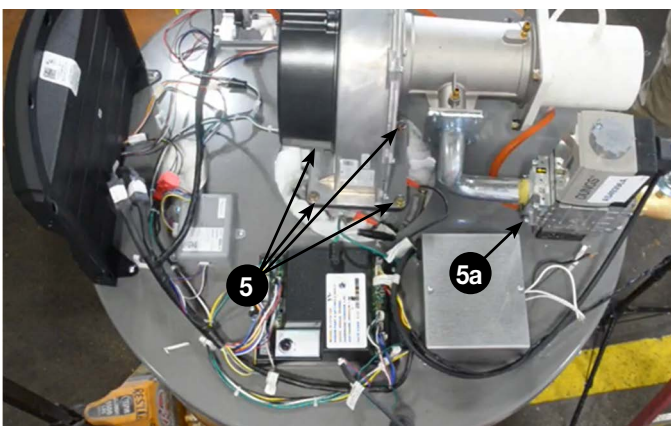

6. Once the bolts are removed, remove the entire blower assembly.

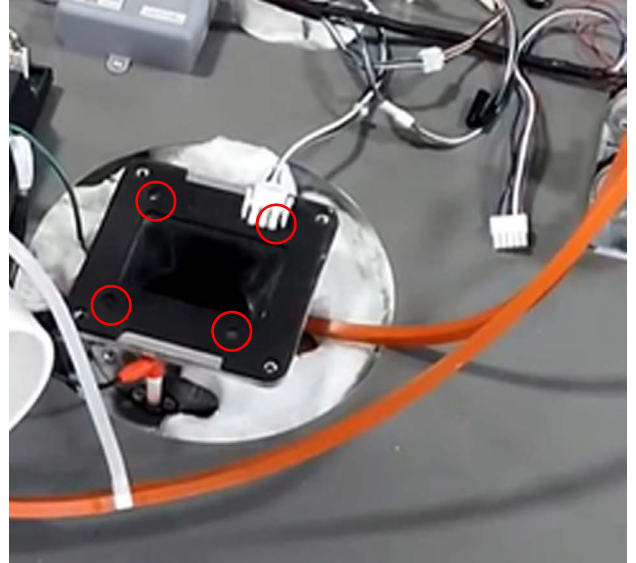

7. If at the 24" clearance remove the collar. Use a #2 Philips screwdriver to remove the screws holding the collar to the plate by using the holes in the top of the collar to reach the screws. (see above picture circles)
8. With collar removed the burner can be removed and replaced.

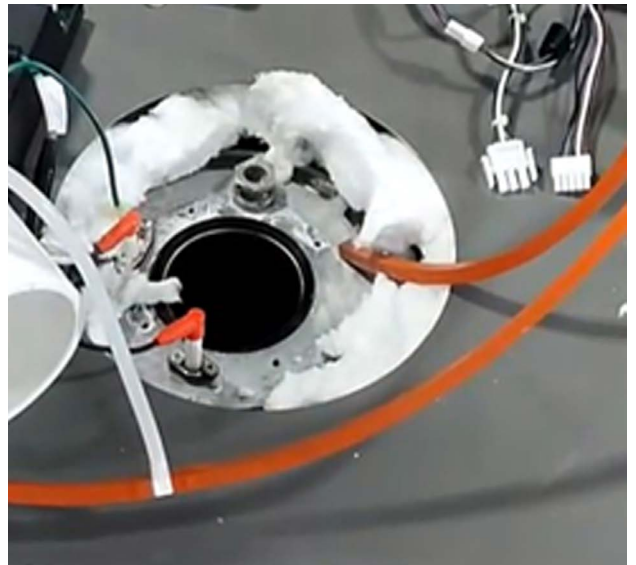

9. To remove whole system, also remove the 5 bolts attaching the burner plate to the top of the water heater.
10. Remove old burner and the gasket.
11. To replace the burner, align the notch, take the new burner and gasket and attach using the screws provided.

DISASSEMBLY AND REPAIR

12. Make sure to attach the blower to the burner in the same orientation as it has been attached previously. (if assembled off of the unit)
13. Insert the burner assembly back into the top of the water heater making sure that the air intake and the gas valve are pointing towards the back.
14. Bolt the burner assembly back into place and make sure to tighten all of the bolts using the ratchet and half inch socket.
15. Reconnect the ground to the igniter and reconnect the ignitor lead to the control box
16. Reconnect the lead from the flame rod sensor to the control box
17. Reconnect the two leads to the low gas pressure. (it does not matter which lead is connected to which tab)
18. Reconnect the two harnesses to the front of the blower
19. Reattach the cable harness to the back of the valve and secure it with the screw.
20. Reattach the intake hose to the front of the gas valve and the POF switch to the bottom of the blower.

Replacement of wire harnesses (Triton SD):

1. Disconnect wires from heater components.
2. Disconnect from the leads on the top of the unit.
3. Use a flat head screw driver to pry under the grommet on the top of the conduit. There is adhesive that will be released.
4. At the bottom of the harness attach wire puller, string, etc. to be pulled through the conduit.

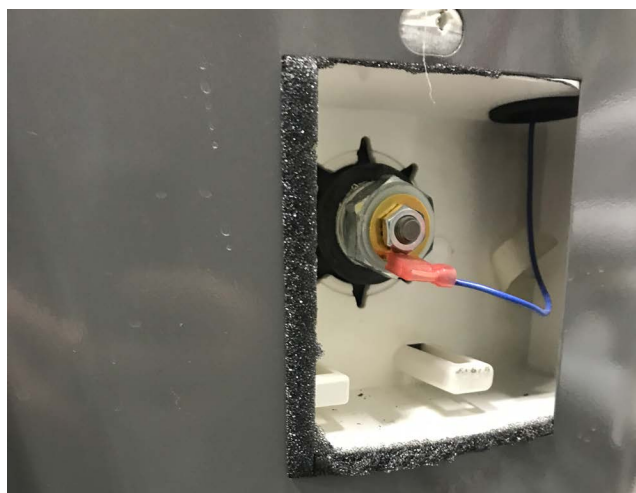
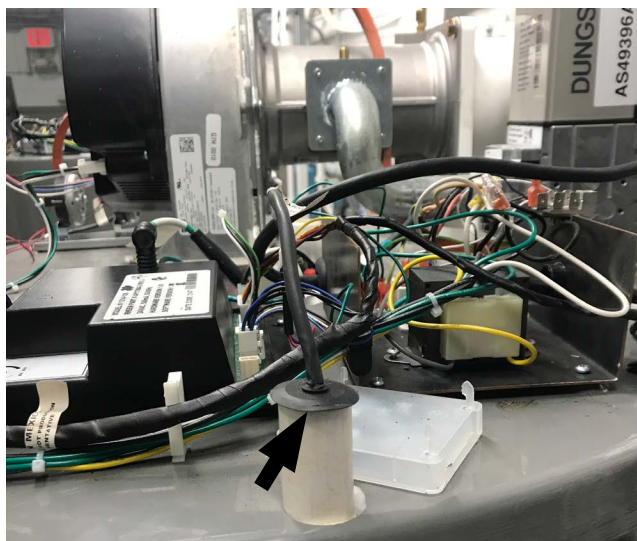

5. Once removed, attached pulling device to end of new harness and feed back through the conduit.
6. Once the harness has reached the bottom, reconnect all connectors to corresponding locations.

BACNET CONFIGURATIONS

BACnet and What to Know

BACnet capability is ONLY available on premium models which come with the wiring connector needed to connect the unit to a BACnet network.

BACnet is a communications protocol for Building Automation and Control (BAC) networks that leverage the ASHRAE, ANSI, and ISO 16484-5 standard protocol.

BACnet was designed to allow communication of building automation and control systems for applications such as heating, ventilating, and air-conditioning control (HVAC), water heating, etc. The BACnet protocol provides mechanisms for computerized building automation devices to exchange information, regardless of the particular building service they perform.

It is important to understand that Rheem in no way supports BACnet itself. We are only able to provide direction within our product to the location for data input. For example, if a BACnet Facilitator called needing to input their configurations, we would be asked to direct him or her to the location in our menu to enter their configurations. **IF AN END USER CALLS REQUESTING BACNET SUPPORT, WE MUST DIRECT THEM TO THEIR BACNET FACILITATOR OR IT SPECIALIST.**

Configurations

When speaking with a BACnet facilitator, walk the caller through how to access configuration settings in order to input their EXISTING network numbers. (We do not provide these...These come from their network/BACnet facilitator)

- Before beginning, ensure heater has a network connection by verifying the WiFi symbol located in the top left hand corner does NOT have a line through it, as image below.

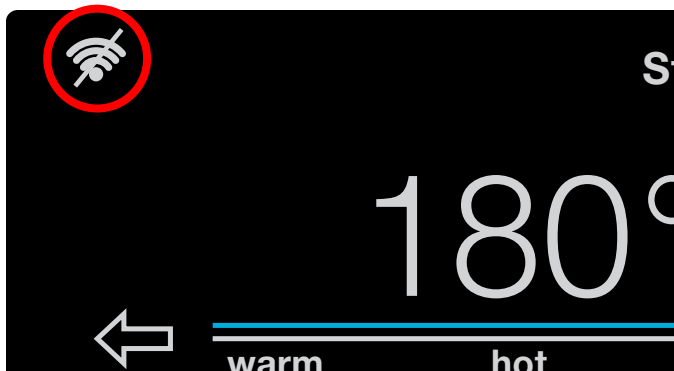

- Verify that the caller has MSTP (Master Slave Token Passing) BACnet. If their network is not MSTP, our product will not be able to access the internet. Verify this by asking the caller if their network is MSTP BACnet. If they do not know, direct them to their BACnet Facilitator. WE DO NOT HAVE OR PROVIDE THIS INFORMATION.

- Before beginning, ensure heater has a network connection by verifying the WiFi symbol located in the top left hand corner does NOT have a line through it, as pictured below.
- To access the menu containing BACnet configurations, the caller will select the “settings” icon in the bottom left of their display screen as image below.

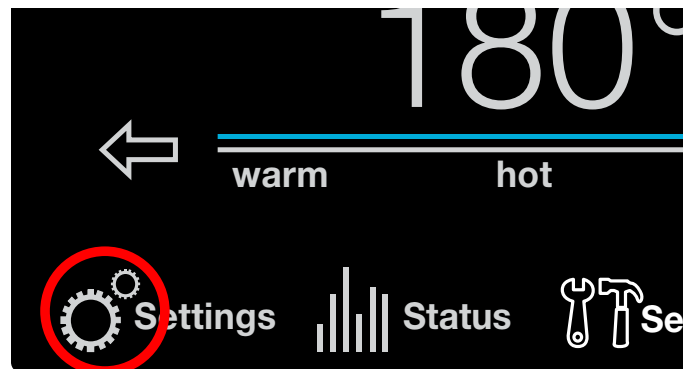

- From this screen he or she will select “BACnet” on the second row of icons.

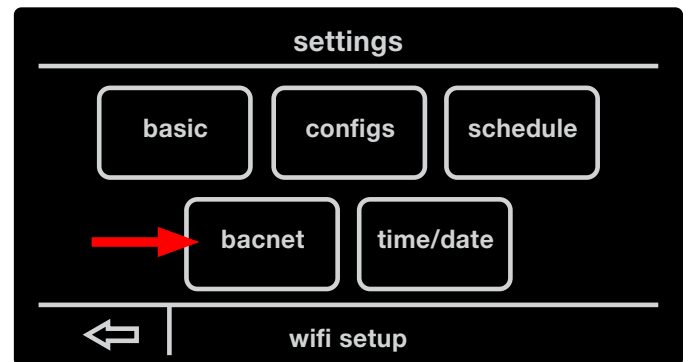

BACNET CONFIGURATIONS

“Where Do I Go to Input my Device Instance?”

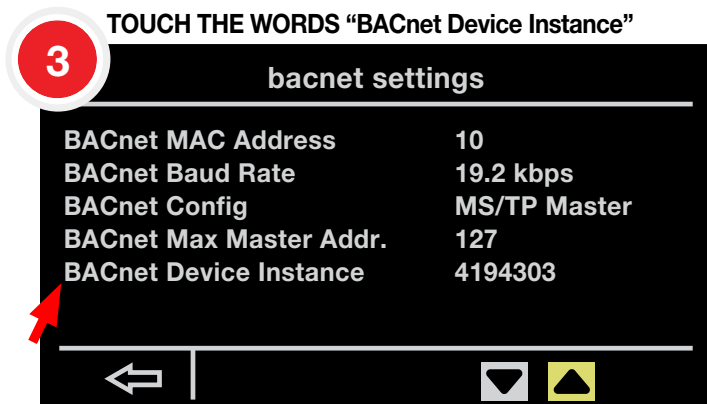
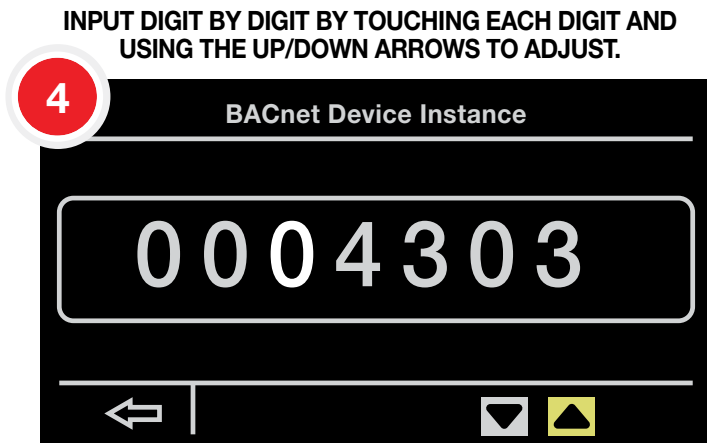
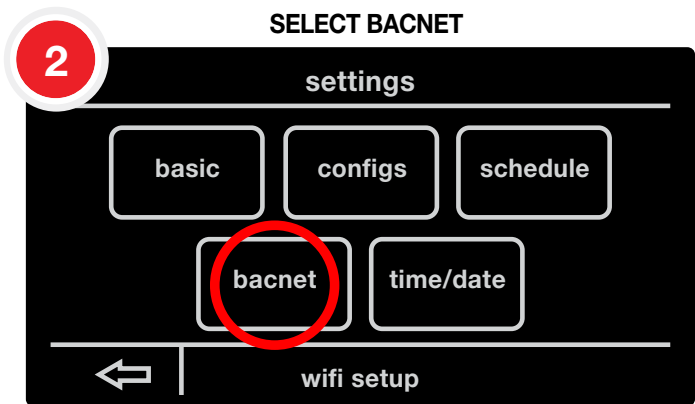
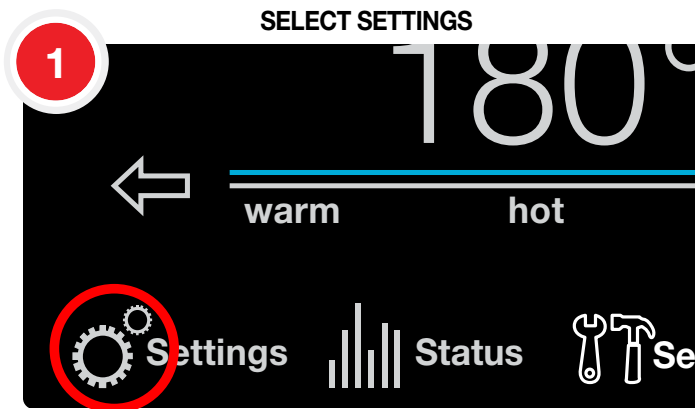

NOTE- Device Instance will likely be the most common configuration adjustment. All other items should be left alone unless adjusted by a BACnet Facilitator

BACNET CONFIGURATIONS

- This will open 'BACnet Settings' and will list the BACnet MAC address, Baud rate, BACnet Config, Max Master Address, and Device Instance.
- Each item can be selected by touching the item on the screen. Once selected, changes can be made.

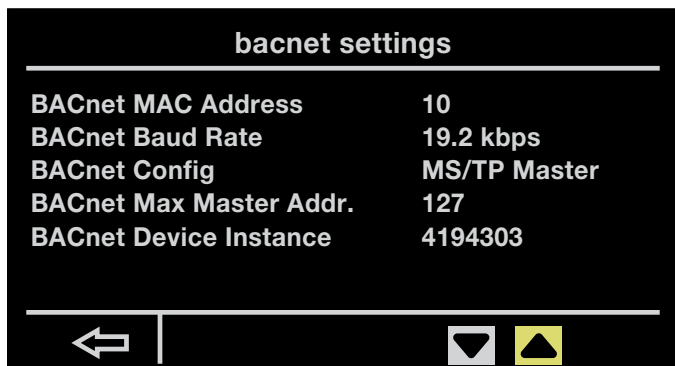

The BACnet Facilitator will have the BACnet MAC Address. This does not come from us. If the caller is an end user, he/she will need to contact a BACnet Facilitator.

The Baud Rate should only in very rare circumstances be adjusted. Rheem support does NOT under any circumstances provide advice for this setting.

The BACnet config should always be left as MS/TP MASTER.

The Max Master Addr should always be left at 127 unless the BACnet Facilitator wants to change it. An end user should never change this and Rheem support should never suggest it.

The device instance will also come from the BACnet facilitator. If the DI is 4194303, it is defaulting and not connected to the network. The BACnet Facilitator will have to enter these numbers.

NOTE: Premium Triton units come with the wiring connector needed to connect unit to BACnet network. THIS IS ONLY INCLUDED WITH PREMIUM MODELS.

NOTE: WE SHOULD ONLY ADVISE CALLERS WHERE TO GO TO ENTER/ADJUST THESE SETTINGS, AND NEVER ATTEMPT TO PROVIDE THEM WITH THE CONFIGURATIONS.

BACnet Quick Start Guide

NOTE: This water heater is compatible with BACnet RS-485 physical layer only.

PINOUT:

Pin Number	Description
1	Ground (Optional)
2	RS-485 Minus (D-)
3	RS-485 Plus (D+)
4	Common (100Ω resistor to ground)

INSTRUCTIONS:

1. Wire up the BACnet connections per the given pinout
2. Plug in the connector to the heater as shown. The connector plugs in to the top, green connector to the left of the display. When connected properly, the screws will face the back of the water heater, and pin 4 will be to the top.
3. After connecting, select "Settings" and, then, "bacnet" on the display to modify the BACnet settings. See the below details on configuring the BACnet settings.

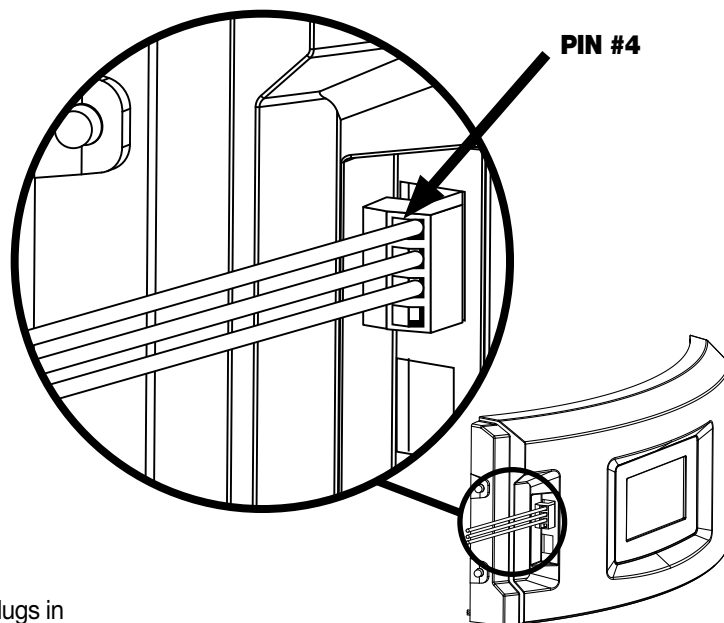

BACNET CONFIGURATIONS

BACNET SETTINGS DETAILS:

BACnet Setting	Default Value	Additional Information
BACnet MAC Address	1	Range: 0 to 127 for MS/TP Master and 0 to 254 for MS/TP Slave When possible, 0 should be avoided. Must be unique among all devices on a given BACnet network segment.
BACnet Baud Rate	38.4 kbps	kbps: kilo-bits per second Options: 9.6 kbps, 19.2 kbps, 38.4 kbps, 57.6 kbps, 76.8 kbps, or 115.2 kbps
BACnet Config	MS/TP Master	Options: MS/TP Master or MS/TP Slave
BACnet Max Master Address	127	Only applicable if BACnet Config is set to MS/TP Master. Range: 0 through 127
BACnet Device Instance	4,194,303	Range: 0 through 4,194,303 The default value indicates unassigned instance, and should not be used. Instance must be assigned for use. Must be unique across devices on all BACnet network segments of the BACnet internetwork.

LEAK GUARD™

What is LeakGuard™

LeakGuard is a proprietary auto shut-off system that prevents catastrophic damage and allows no more than 24 ounces of water to escape the tank in a vacuum lock. This feature comes with on premium models. The modes of operation are generally set to Auto, which is preferred and are based on the hours of operation.

LeakGuard™ is available on premium models only. The control is programmable to allow detection of leak to “Alarm Only” and allow the unit to continue to operate, or to “Disable” the unit and close the automatic shut-off valve. The valve exercises itself once a month (Sunday at 1am) to ensure it is in operation and to keep the valve from clogging up from sediments/debris. The unit WILL NOT heat if control board can not confirm valves as OPEN.

Valve can be checked for the following error codes:

A110 and A11 – Shut-off Valve Monthly Test Close/Open Error

- Drain the tank and remove the automatic shutoff valve. Clean any debris from inside valve body and manually rotate the ball valve to ensure the motor is not seized up.
- Reinstall the valve, fill the tank with water, and clear the alarm. If issue occurs again next month then the valve is defective or we have heavy amounts of sediment in the water supply and some form of water filtering system may need to be utilized to prevent buildup from occurring.
- If no sediments/debris are present in the valve but alarm keeps occurring, replace the automatic shutoff valve.

A112 – The control board is not seeing the valve as being “OPEN”.

- Confirm the Molex connectors from valve to water heater wiring is securely connected.
- Confirm no wires are loose/damaged in Molex connectors from valve to water heater.
- Manually open the shutoff valve by rotating the Allen head screw on top of the valve actuator. Clear the alarm. If the alarm persists, replace the automatic shutoff valve.
- The control board will not allow the unit to heat water until the shut-off valve is confirmed “OPEN”
- *The red line on the valve indicator shows if the valve is open or closed. See photo below. If the valve is open, the red line will be straight in line with the water flow. If the valve is closed, the line will be horizontal to the water flow.*

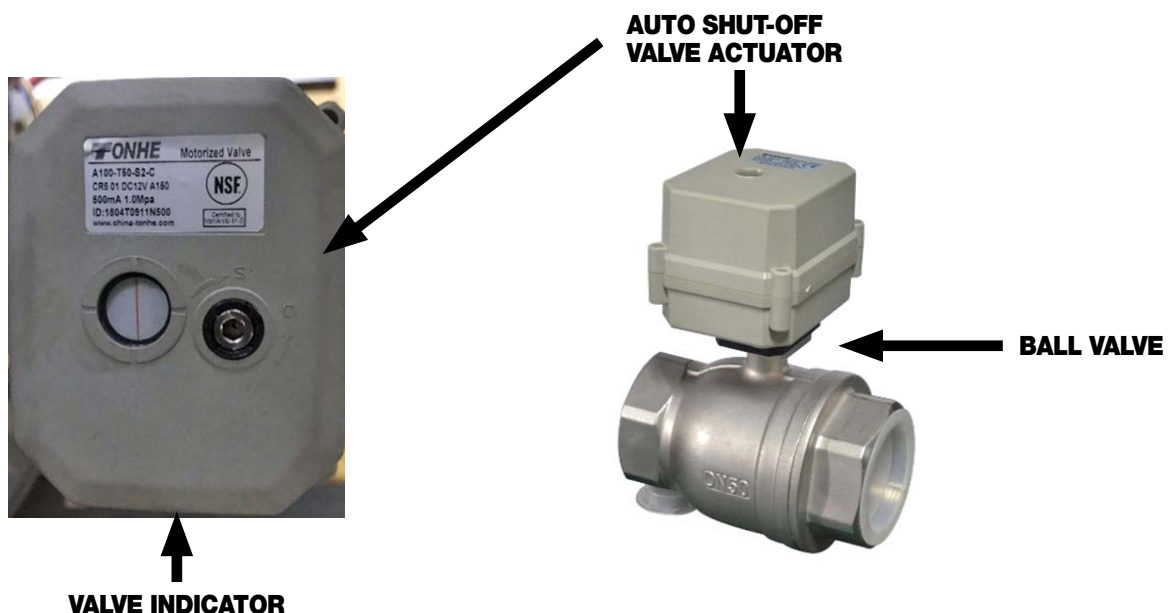



TECHNICAL SUPPORT LINE

PHONE: 800-432-8373

FAX: 334-260-1341

ORDER CENTER

1-800-621-5622

RHEEM WATER HEATERS

800 Interstate Park Dr.

Montgomery, AL 36109

Website: www.rheem.com

Email: Techserv@Rheem.com