



The new degree of comfort.®



Residential Electric
Professional *Prestige* ProTerra
Hybrid Water Heaters

Professional *Prestige*® ProTerra™ Hybrid Electric with LeakGuard™ is the most efficient water heater available

Efficiency

- Up to 4.0 UEF reduces operating cost
- ENERGY STAR® rated

Performance

- Delivers hot water faster than most standard electric water heaters
- Ambient operating range: 37-145° F is widest in class, offering more days of HP operation annually; designed to meet Northern Climate Spec (Tier 4)

Easy Installation

- Easy access side connections
- Quick access to electrical junction box
- Easily replaces a standard electric water heater

Integration

- LED Screen with built-in water sensor alert with audible alarm¹
- Integrated EcoNet® WiFi-connected² technology and free mobile app gives users control over water heater, allowing for customizable temperature, vacation settings, energy savings and system monitoring at home or away. Visit Rheem.com/hybridsolutions



- Integrated leak detection and prevention system with factory installed auto water shut-off valve limits leaks to no more than 20 ounces of water^{1, 3}
- LeakSense™ Built-in Leak Detection System detects any leak large or small, internal or external^{1, 4}. For models without LeakGuard, please purchase Kit # SP21111 for the LeakSense option

Operation Modes

- Energy Saver
- Heat Pump
- High Demand
- Electric
- Vacation/Away: 2-28 days (or placed on hold indefinitely)

Plus...

- Premium grade anode rod with resistor extends the life of the tank
- 3/4" NPT water inlet and outlet; 3/4" condensate drain connections
- Incoloy stainless steel resistor elements
- Dry-fire protection
- Easy access, top mounted washable air filter
- 2" Non-CFC foam insulation
- Enhanced flow brass drain valve
- Temperature and pressure relief valve installed
- Design certified to NSF/ANSI 372 (Lead Content)

Warranty

- 10-Year limited tank and parts warranty
See Residential Warranty Certificate for complete information



Professional *Prestige* ProTerra Hybrid

40, 50, 65 and
80 - US Gallon Capacities
208-240 Volt / 1 PH
Electric



LEED Points = 3

¹Available with select models. ²WiFi broadband internet connection required. ³Source: Rheem Leak-Sensing Data; testing under a vacuum lock using 50-gallon tank, no expansion tank, average tank pressure of 40 psi, assuming no additional faucets are opened. ⁴Water leaks from the heater only, as tested across scenarios including a minimum of 5.5mL/hr volume leak rate, using most common installation scenarios.

See specifications chart on next page.



INTEGRATED HOME COMFORT

Professional *Prestige*® ProTerra Hybrid Specifications

DESCRIPTION						ENERGY INFO	FEATURES						SHIPPING WEIGHTS	
NOMINAL US GALLON CAPACITY	RATED US GALLON CAPACITY	IMP. GALS CAPACITY	MODEL NUMBER	MODEL VARIANT	ELECTRIC BREAKER SIZE	UNIFORM ENERGY FACTOR (UEF)	COMPRESSOR BTU/H	UEF FIRST HR. RATING G.P.H.	RECOVERY IN G.P.H 90° F RISE	ELEMENT WATTAGE	TOTAL UNIT WATTAGE	MAX AMPS	UNIT WT. (LBS.)	APPROX. SHIP WT. (LBS.)
ProTerra with LeakGuard and LeakSense														
40	36	33	CPROPH40 T2 RH375-SO	701345	30	3.75	4,200	60	26	4,500	5,000	21	157	174
50	45	42	CPROPH50 T2 RH375-SO	701354	30	3.75	4,200	67	27	4,500	5,000	21	178	218
65	59	54	CPROPH65 T2 RH375-SO	701363	30	3.85	4,200	75	27	4,500	5,000	21	225	262
80	72	67	CPROPH80 T2 RH375-SO	701355	30	4.00	4,200	87	27	4,500	5,000	21	244	281
ProTerra 30 Amp without LeakGuard (no LeakSense)														
40	36	33	CPROPH40 T2 RH375-30	701361	30	3.75	4,200	60	27	4,500	5,000	21	157	174
50	45	42	CPROPH50 T2 RH375-30	701369	30	3.75	4,200	67	27	4,500	5,000	21	178	218
65	59	54	CPROPH65 T2 RH375-30	701370	30	3.85	4,200	75	27	4,500	5,000	21	225	262
80	72	67	CPROPH80 T2 RH375-30	701372	30	4.00	4,200	87	27	4,500	5,000	21	244	281
ProTerra 15 Amp without LeakGuard (no LeakSense)														
40	36	33	CPROPH40 T2 RH375-15	701350	15	3.45	4,200	46	16	2,250	2,750	12	157	174
50	45	42	CPROPH50 T2 RH375-15	701358	15	3.75	4,200	52	16	2,250	2,750	12	178	218
65	59	54	CPROPH65 T2 RH375-15	701349	15	3.55	4,200	54	16	2,250	2,750	12	225	262
80	72	67	CPROPH80 T2 RH375-15	701356	15	3.70	4,200	67	16	2,250	2,750	12	244	281

Notes: LeakSense is included with all LeakGuard models.
 Models without LeakGuard do not include the LeakSense option installed.
 To add the LeakSense option, please order Kit # SP21111.

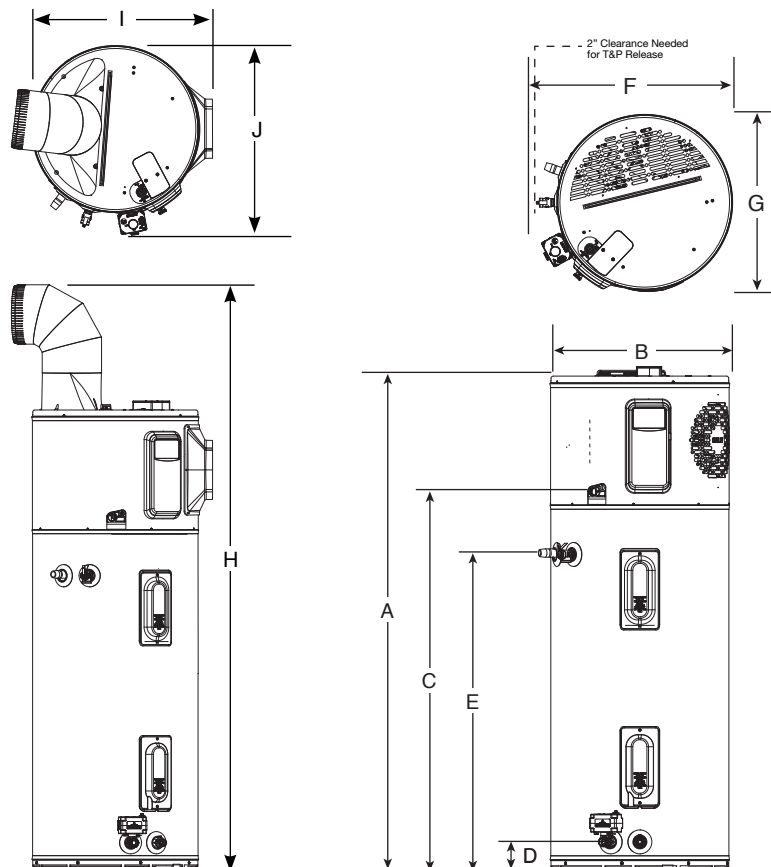

DESCRIPTION				DIMENSIONS (SHOWN IN INCHES)									
NOMINAL US GALLON CAPACITY	RATED US GALLON CAPACITY	IMP. GALS CAPACITY	MODEL NUMBER	A	B	C	D	E	F	G	H	I	J
40	36	33	CPROPH40	62-5/16	20-1/4	47	3-5/8	39-5/8	23-3/8	20-1/2	78-7/8	22-3/8	23-1/4
50	45	42	CPROPH50	61-3/4	22-1/4	47	3-5/8	39-5/8	25-3/8	22-1/2	78-5/8	24-3/8	25-9/16
65	59	54	CPROPH65	64-3/16	24-1/4	49	3-7/8	42-3/8	27-1/2	24-5/8	81-1/8	26-1/2	27-3/8
80	72	67	CPROPH80	74-3/16	24-1/4	59	3-7/8	42-3/8	27-1/2	24-5/8	91	26-1/2	27-3/8

Hybrid Water Heater Installation Guidelines to Provide Optimal Efficiency

Heater: Not Ducted

Room size: Larger than 700 ft³ (e.g. 7' x 10' x 10').
 Requirements: No additional ventilation needed.

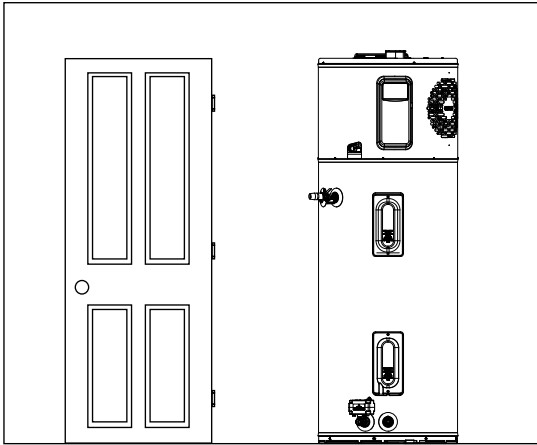

Heater: Not Ducted

Room size: Smaller than 700 ft³ (e.g. 7' x 10' x 10').
 Requirements: Full louvered door OR two louvers top and bottom. See below.

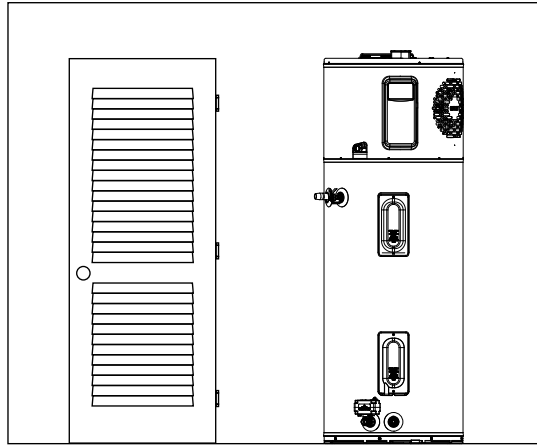

Heater: Not ducted

Room: Small Closet

- Requirements:
- * Air gap under door equal to 18 in² (0.75" clearance).
 - * Louver must be located the same height on door as the air exhaust on heater.
 - * Heater air exhaust must be positioned towards louver within one foot of door.

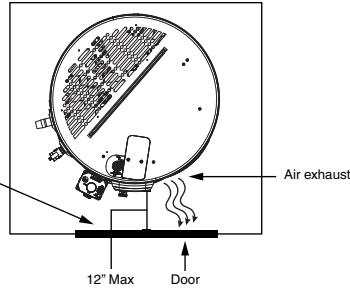
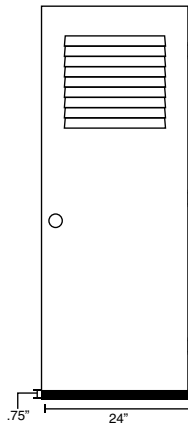

Heater: Ducted with inlet OR outlet duct

Room size: Any size room
 Requirements: Air gap under door equal to 18 in² (0.75" clearance)

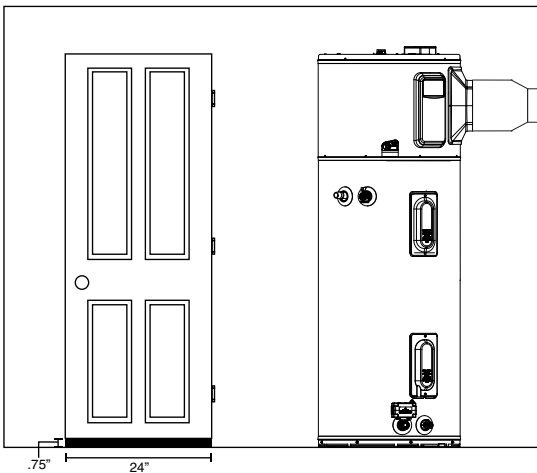

Heater: Ducted with inlet AND outlet duct

Room size: Any size room
 Requirements: No additional ventilation needed.

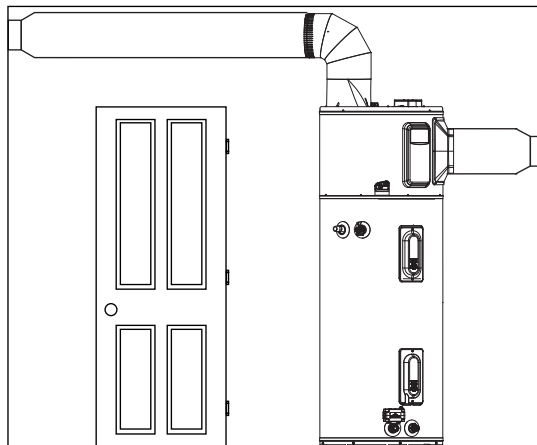



The new degree of comfort®



Residential Electric
Professional *Prestige ProTerra*
Hybrid Water Heaters

Hybrid Accessories List

PART NUMBER	DESCRIPTION	USE FOR
AP19134	Leak Sensor	Automatic detection of internal and external leaks
AP20180	Shutoff Valve	Automatic shut off of water supply to unit
AP21365	Inlet Duct Adapter	Allows for ducting to be connected on the top inlet
AP17829	Outlet Duct Adapter	Allows for ducting to be connected to the unit
SP20882	Earthquake Isolation Kit	Installations in seismic regions
SP20883	Vibration Isolation Kit	Installation on non-concrete floors
SP20884	8" Diameter UL Certified Termination Kit	Termination to the outside or to the attic with 8" diameter
SP20885	7" Diameter UL Certified Termination Kit	Termination to the outside or to the attic with 7" diameter
SP20886	6" Diameter UL Certified Termination Kit	Termination to the outside or to the attic with 6" diameter
SP20887	5" Diameter UL Certified Termination Kit	Termination to the outside or to the attic with 5" diameter
SP20888	8" Rheem Approved Damper Kit	Exhaust only to the outside ducting configuration (no inlet duct)
SP20889	25' Flexible 8" Diameter Duct Kit	For up to 25' of ducting
SP20890	Rigid Elbow Duct Kit	Installation in tight places where space needs to be minimized
UPGRADE KIT		
SP21111	Leak Sensor & Shutoff Valve Kit	Upgrade ProTerra 15 and 30 Amp models to protect your customers home from water damage with leak detection and auto shutoff valve

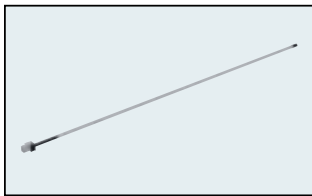

AP19134 - Leak Sensor



AP20180 - Shutoff Valve



AP21365 - Inlet Duct Adapter



AP17829 - Outlet Duct Adapter



SP20882 - Earthquake Isolation Kit



SP20883 - Vibration Isolation Kit

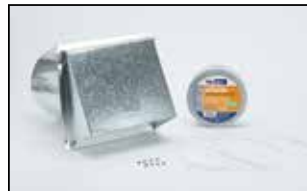

SP20884 - 8" Diameter UL Certified Termination Kit



SP20885 - 7" Diameter UL Certified Termination Kit



SP20886 - 6" Diameter UL Certified Termination Kit



SP20887 - 5" Diameter UL Certified Termination Kit



SP20888 - 8" Rheem Approved Damper Kit



SP20889 - 25' Flexible 8" Diameter Duct Kit



SP20890 - Rigid Elbow Duct Kit

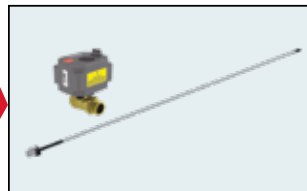
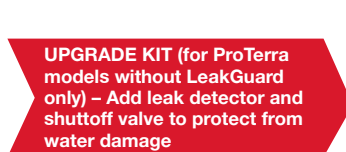

SP21111 - Leak Sensor & Shutoff Valve Kit

In keeping with its policy of continuous progress and product improvement, Rheem reserves the right to make changes without notice.

Rheem Canada Ltd./Ltée • 125 Edgeware Road, Unit 1
Brampton, Ontario L6Y 0P5 • www.rheem.ca



INTEGRATED HOME COMFORT