



SUBMITTAL COVER SHEET

PROJECT NAME _____

LOCATION _____

ARCHITECT _____

ENGINEER _____

CONTRACTOR _____

SUBMITTED BY _____ DATE _____

UNIT SUMMARY

Quantity						
Unit Designation						
Model No.						
Total Cooling						
Sensible Cooling						
Air Ent. Evaporator						
Air Lvg. Evaporator						
Heating Input						
Heating Output						
CFM/ESP						
EER/SEER						
Electrical						
Minimum Ampacity						
Min.-Max. Breaker						
Net Unit Weight						
Accessory						
Catalog Form Number						

ACCESSORIES:

NOTES:

UPFLOW/HORIZONTAL GAS FURNACE

S801T Ultra Low NOx Series

80% A.F.U.E.†

Input Rates 50 to 100 kBTU [14.7 to 29 kW]

JOB NAME _____ MODEL NO. _____

CONTRACTOR _____ OUTDOOR UNIT MODEL NO. _____

ENGINEER _____ LOCATION _____

SUBMITTED FOR APPROVAL RECORD ORDER NO. _____

DATE _____

UNIT DATA

HEATING PERFORMANCE

TOTAL CAPACITY INPUT* MBH [kW]

TOTAL CAPACITY OUTPUT* MBH [kW]

DESIGN TEMP. RISE °F [°C] DB

AFUE %

CALIFORNIA SEASONAL EFFICIENCY %
(*uses blower motor heat)

SUPPLY AIR BLOWER PERFORMANCE

TOTAL AIR SUPPLY CFM [L/s]

TOTAL RESISTANCE EXTERNAL TO UNIT IWG

BLOWER SPEED RPM

POWER OUTPUT REQUIREMENT BHP

MOTOR RATING HP [W]

POWER INPUT REQUIREMENT kW

ELECTRICAL DATA

POWER SUPPLY Hz

TOTAL UNIT AMPACITY AMPS

MINIMUM WIRE SIZE AWG

MAXIMUM OVERCURRENT DEVICE FUSES/HACR BREAKER AMPS

FEATURES FOR S801T UPFLOW/HORIZONTAL

- 80% residential Gas Furnace CSA certified
- 3 way multi poise design UF / HZ
- Diagnostics – 7 Segment LED all units
- Ignition System – DSI for reliability and longevity
- Heat exchanger is removable for improved serviceability. Stainless steel construction provides maximum corrosion resistance and thermal fatigue reliability.
- Solid doors provide quiet operation
- Solid bottom
- Insulated blower compartment
- Low profile 34" cabinet ideal for space constrained installations
- Blower shelf design – serviceable in all furnace orientations
- Hemmed edges on cabinets and doors
- 1/4 turn door knobs for tool less access
- Integrated Control board features dip switches for easy system set up
- QR code for quick access to product information from your smart phone or tablet
- Constant Torque electrically commutated motor

FIELD INSTALLED ACCESSORIES

- External Bottom Filter Rack RXGF-CB
- External Side Filter Rack RXGF-CD
- Indoor Coil Casing RXBC-D17A1
- Indoor Coil Casing RXBC-D21B1
- Solid Bottom Kit RXGB-D17
- Solid Bottom Kit RXGB-D21
- 4" Flue Adapter RXGW-C01



Horizontal Application

WARNING

THIS FURNACE IS NOT APPROVED OR RECOMMENDED FOR INSTALLATION ON ITS BACK, WITH ACCESS DOORS FACING UPWARDS.

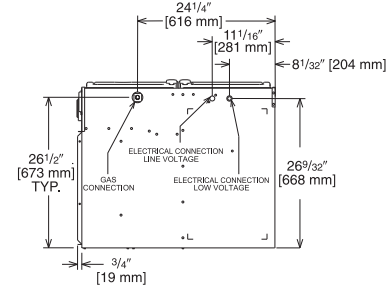
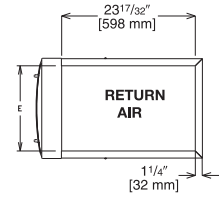
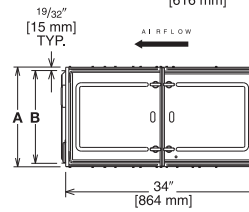
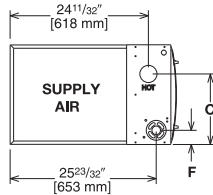
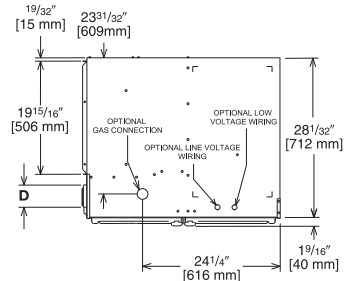

Upflow Application

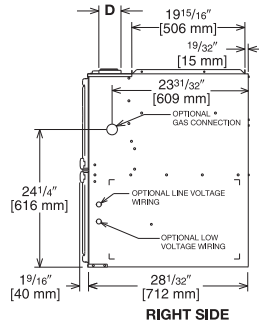
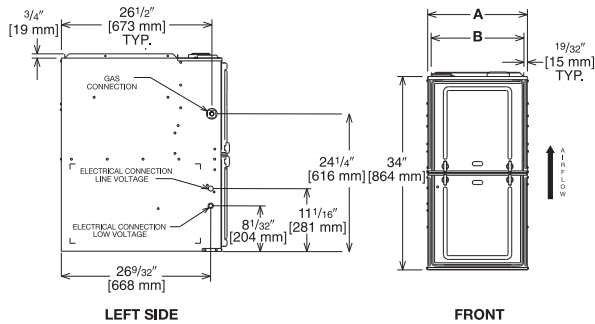
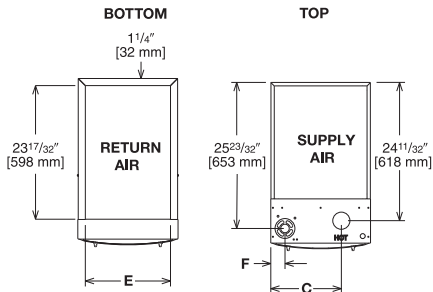

Illustration ST-A1220-04-00 FIGURE 2

Illustration ST-A1220-04-00 FIGURE 1

Unit Dimensions

MODEL R801T-	A	B	C	D	E	F	REDUCED CLEARANCE (IN.) [mm]						SHIP WGTS. (LBS.) [kg]
							LEFT SIDE	RIGHT SIDE	BACK	TOP	FRONT	VENT	
050	17 1/2 [445]	16 11/32 [415]	12 3/8 [314]	①	15 [381]	2 1/2 [64]	0	3 [76] ②	0	1 [25]	3 [76]	6 [152] ③	125 [57]
070	17 1/2 [445]	16 11/32 [415]	12 3/8 [314]	①	15 [381]	2 1/2 [64]	0	3 [76] ②	0	1 [25]	3 [76]	6 [152] ③	125 [57]
100	21 [533]	19 27/32 [504]	14 1/8 [359]	①	18 1/2 [470]	2 1/2 [64]	0	0	0	1 [25]	3 [76]	6 [152] ③	140 [64]

NOTES: ① May require a 3" [76 mm] to 4" [102 mm] or 3" [76 mm] to 5" [127 mm] adapter. 4" adapter included with (-)801P units.

② May be 0" [0 mm] with type B vent.

③ May be 1" [25 mm] with type B vent.

Furnaces must be vented in accordance with the National Fuel Gas Code, ANSI Z223.1 and in accordance with local codes.

[] Designates Metric Conversions

Before proceeding with installation, refer to installation instructions packaged with each model, as well as complying with all Federal, State, Provincial, and Local codes, regulations, and practices.

Sure Comfort® Heating and Cooling
P.O. Box 17010, Fort Smith, AR 72917

"In keeping with its policy of continuous progress and product improvement, Sure Comfort® reserves the right to make changes without notice."