

Eemax, Inc.™ Electric Tankless Water Heaters

INSTALLATION INSTRUCTIONS & OWNER'S MANUAL

HotMax™

HM013240

IMPORTANT SAFETY INFORMATION

When installing or using any high voltage electrical appliance, basic safety precautions should always be followed. Under no circumstance should you attempt to clean, install, inspect, repair, disassemble or otherwise service this water heater, without first shutting off **all** power to the unit directly at the circuit breaker box. **SERIOUS BODILY INJURY OR DEATH COULD OCCUR IF YOU IGNORE THIS WARNING.**

THIS PRODUCT SHOULD BE INSTALLED BY A QUALIFIED ELECTRICIAN AND A QUALIFIED PLUMBER IN ACCORDANCE WITH ALL NATIONAL, STATE, PROVINCIAL AND LOCAL ELECTRICAL & PLUMBING CODES.

PLEASE READ THESE INSTRUCTIONS THOROUGHLY AND COMPLETELY PRIOR TO INSTALLATION & USE. FAILURE TO DO SO COULD CAUSE PROPERTY DAMAGE, SERIOUS INJURY, OR DEATH.

This manual should be given to the owner after installation and should be retained for future reference.



Tested and certified by the Water Quality Association against NSF/ANSI 372 for lead free compliance.



Recognize this symbol as an indication of Important Safety Information!

DO NOT destroy this manual. Please read carefully and keep it in a safe place for future reference

IMPORTANT SAFETY INFORMATION.

READ ALL INSTRUCTIONS BEFORE USING



DANGER! **WATER TEMPERATURE SAFETY SETTING**

Safety and energy conservation are factors to be considered when selecting the water temperature setting of water heater's thermostat. This product is subject to water temperatures above 120°F (49°C) which can cause severe burns or death from scalding. Be sure to read and follow the warnings outlined on the label pictured below. This label is also located on the water heater near the thermostat access panel.

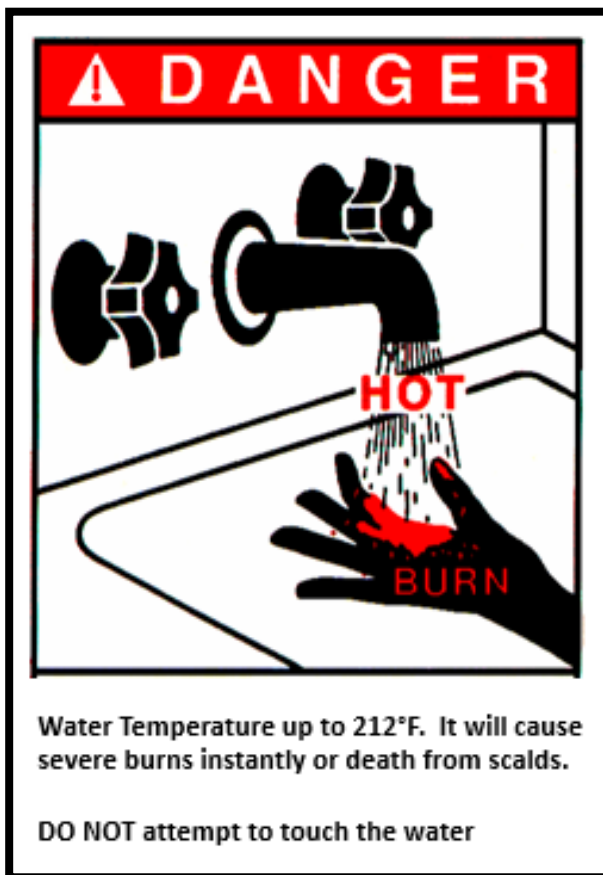

Time/Temperature Relationship in Scalds

Water Temperature	Time to Produce a Serious Burn
120°F (49°C)	More than 5 minutes
125°F (52°C)	1 1/2 to 2 minutes
130°F (54°C)	About 30 seconds
135°F (57°C)	About 10 seconds
140°F (60°C)	Less than 5 seconds
145°F (63°C)	Less than 3 seconds
150°F (66°C)	About 1 1/2 seconds
155°F (68°C)	About 1 second

Table courtesy of Shriners Burn Institute

The chart above shows water temperatures to 155°F (68°C). **This unit is subject to water temperatures up to 212°F (100°C) which can produce a serious burn instantly.**



DANGER HotMax is not intended for use by small children, disabled, or elderly persons unless given instructions or supervision by a person responsible for their safety. To reduce the risk of injury, children should not play with the hot water tap and should be closely supervised when the appliance is in use.

Please consult Section 9 to learn more about setting HotMax temperature. Rotate clockwise for higher temperature up to 200°F (93°C) or rotate counterclockwise for cooler temperature as low as 140°F (60°C)

Notice: To comply with safety regulations the thermostat is set at 140°F before the water heater is shipped from the factory.

ABOUT YOUR HOTMAX

Congratulations on the purchase of your HotMax! You have purchased the most technologically-advanced electric tankless water heater on the market today designed to produce an endless amount of near boiling hot water instantly.

Your new electric tankless water heater features advanced water flow rate and temperature sensors designed to modulate power to the heating elements to maintain a user-selected output water temperature between 140°F (60°C) and 200°F (93°C) (subject to incoming water temperature).

To get the best near boiling hot water dispensing performance and energy savings from your electric tankless water heater, it is important that it be installed in accordance with our instructions and the electrical and plumbing codes applicable to your area, and that you read this manual thoroughly for important operating instructions and tips.

If you have questions at any time, please contact us directly at:

Manufacturer's National Service Department

400 Captain Neville Dr. Waterbury, CT 06705

Phone: 1-(800)- 543-6163 Email: Support@eemaxinc.com

CONTENTS

ABOUT YOUR HotMAX	3
CONTENTS	3
1- BEFORE INSTALLATION.....	4
2- SELECTING A LOCATION TO INSTALL.....	4
3- MOUNTING YOUR WATER HEATER.....	5
4- DISPENSER/PLUMBING INSTALLATION	7
5- ELECTRICAL INSTALLATION	10
6- GENERAL OPERATING INSTRUCTIONS	12
7- MAINTENANCE	13
8- TROUBLE SHOOTING GUIDE.....	14
9- USER INTERFACE	15

1- BEFORE INSTALLATION

PLEASE READ THESE INSTRUCTIONS THOROUGHLY AND COMPLETELY PRIOR TO INSTALLATION & USE. FAILURE TO FOLLOW INSTRUCTIONS COULD CAUSE PROPERTY DAMAGE, SERIOUS PERSONAL INJURY, OR DEATH.

By installing this product, you acknowledge the terms of the manufacturer's warranty. Once the heater is installed, do not return product to the place of purchase. If you have any questions regarding the warranty or product return policies, please contact Manufacturer's national service department at 1-(800) 543-6163.

Inspect all components. The contents of your box should include the following components:

- HotMax Unit
- Dispenser & Hardware
 - Decorative Washer with O-Ring
 - Rubber Gasket
 - Washer
 - Dispenser Nut
- 20" 4 mm Insulated Copper Tube
- Ferrule x2
- Nut x2



Recommended equipment for installation:

- Electric Drill for Pre-Drilling Holes
- #2 Phillips Bit
- Philips Head Screwdriver
- Flat Head Screwdriver
- Tape Measure/Ruler
- Boiler Drain (may be beneficial)
- Adjustable Wrench
- Pipe Cutter (may be beneficial)
- Pencil (used to mark measurements)
- Needle-Nose Pliers (may be beneficial)
- Level
- Metallic Drain & P-Trap (highly recommended)
- Small Tube Bender (may be beneficial)

2- SELECTING A LOCATION TO INSTALL

This product is designed to be installed indoors under a sink.

⚠ DO NOT install this product in a location where it may be subjected to freezing temperatures. If the water inside your tankless water heater freezes, it can cause severe and permanent damage that is not covered under your warranty.

⚠ DO NOT locate the water heater in a location that is difficult to access.

Make sure that the water heater and hot water outlet pipe are out of reach of children so they are unable to tamper with the temperature controls or injure themselves by touching the hot water outlet pipe. The outlet water pipe can get very hot.

This product does NOT require venting.

⚠ DO NOT install under water pipes or air conditioning lines that might leak or condense moisture that could then drip onto the heater. Avoid installing your tankless water heater in a location prone to excessive humidity, moisture, or dust, or in an area where it may be splashed with water or other liquids.

⚠ DO NOT install above electrical boxes or junctions.

⚠ CAUTION The water heater should not be located in an area where leakage will result in damage to the area adjacent to it or to lower floors of the structure. Where such areas cannot be avoided, it is recommended that a suitable catch pan, adequately drained, be installed under the water heater. Make sure to follow all code requirements for such installations as required for your area. We recommend that you install a drip pan (connected to a safe drain) below the water heater to avoid property damage in the unlikely event of a leak.

Alternatively, you may install an active water leak detector and shutoff valve designed to turn off your water supply in the event that a leak is ever detected.

3- MOUNTING YOUR WATER HEATER

Your HotMax should be secured to the mounting surface with 4 screws (minimum 1" (25.4mm) long) using the built-in mounting holes on the back side of the heater (Figure 1). If using a pre-existing dispenser location, make sure the heater is mounted within 20" of the dispenser fittings. **Make sure that the mounting surface is solid and secure, and ensure that the unit is level prior to securing the screws.** For maximum function and servicing, we recommend that this product be installed in an upright position with the inlet and outlet water connections at the top of the unit. Water connections should be easily accessible under the sink so that the dispenser can be secured and tightened to the heater.

Recommended Clearances for Safety and Service Maintenance:

- 4" (101.6 mm) above
- 9" (228.6 mm) below
- 6" (152.4mm) in front and to the sides

 **DANGER** Flammable materials should be kept at least 24" (609.6mm) away from your water heater and the hot water outlet pipe.

Mounting Steps:

- **SHUT OFF ELECTRICITY ON YOUR CIRCUIT BREAKER BEFORE PROCEEDING TO ANY FURTHER INSTALLATION STEPS.**
- Make sure there is an inlet water line that can supply 0.4 gpm to 0.6 gpm of continuous water flow to HotMax.
- Close the water supply valve on the inlet water line before installation.
- Clear out any obstructions or possible hazards from under the sink before installation.
- Using the mounting template inside the packaging, select a location for HotMax. Be sure to leave the proper clearances on all sides according to the template.

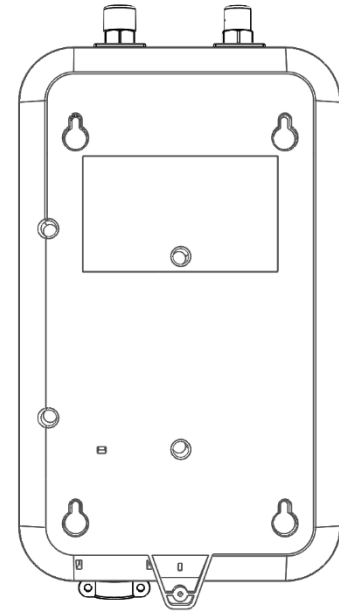
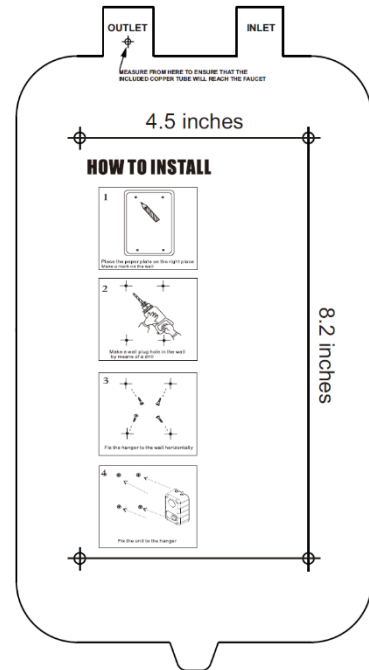

Figure 1



Notice: Before drilling any holes, manufacturer recommends dry fitting the installation to make sure the proprietary copper tube reaches both the intended dispenser location and heater.

- Pre-drill three holes in the locations specified on the mounting template (Figure 2).
- **DO NOT** completely sink all three screws. Leave ¼" clearance to hang the unit. Remove the template and hang the unit.



Figure 2

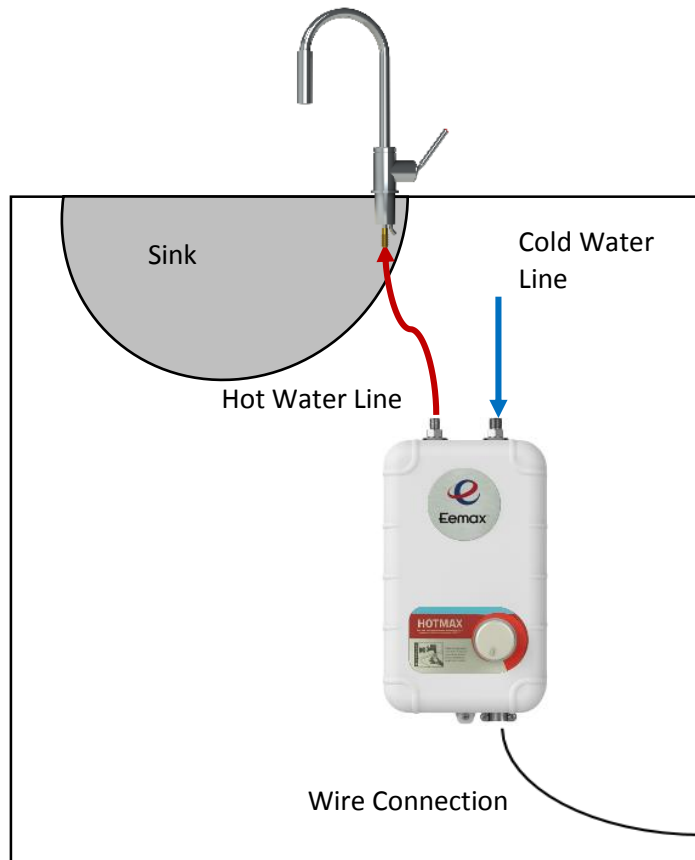

4- DISPENSER/PLUMBING INSTALLATION

Please follow all plumbing and dispenser instructions carefully. We recommend that this product be installed by a licensed and qualified plumber in accordance with all applicable national, state, provincial, and local plumbing codes.

⚠ DO NOT install HotMax with a different dispenser or outlet hot water pipe that is not included in packaging.

DISPENSER INSTALLATION INSTRUCTIONS

STEP 1: Identify which hole in the sink basin will be used for the new dispenser. The location for the dispenser must be within 20" of HotMax and check to make sure there is sufficient clearance for handles to be fully opened. **It is recommended to dry-fit the heater and dispenser connected by the proprietary hot water tube to ensure that the tube is long enough to reach between the two.** The HotMax dispenser requires a 1.5 inch diameter hole to be mounted in the sink basin or countertop.



Figure 3

⚠ CAUTION If you have to drill through a sink or countertop, it is recommended to rent or purchase the appropriate tools. If drilling into a surface other than stainless steel, consult a professional.

STEP 2: Remove components from packaging and connect the dispenser, proprietary outlet tube and fittings. See plumbing installation for more details.

DO NOT pinch, break, or cut the proprietary outlet tubing. Be careful to not damage the fittings.

DO NOT overtighten compression fittings. Ensure all fittings are properly seated in the base of the dispenser head.

DO NOT use pipe dope or Teflon Tape. **Use of pipe dope or Teflon tape may void the warranty.**

STEP 3: Insert the proprietary hot water outlet tube down through the hole in the sink or countertop until the base of the dispenser sits flush on the surface. Seal the dispenser to the sink or countertop with an appropriate sealant before proceeding with plumbing installation. Place the gasket and washer over the threads of the dispenser base. Hand tighten the dispenser nut until the dispenser, gasket and washer are secured to the sink basin or countertop. The dispenser should not be easily moved or twisted once secured. Install Danger: Scald Warning label on the backplash adjacent to the dispenser.

⚠ CAUTION This dispenser does NOT deliver cold water. The dispenser only delivers near boiling hot water that can range from 140°F – 212°F (60°C – 100°C).

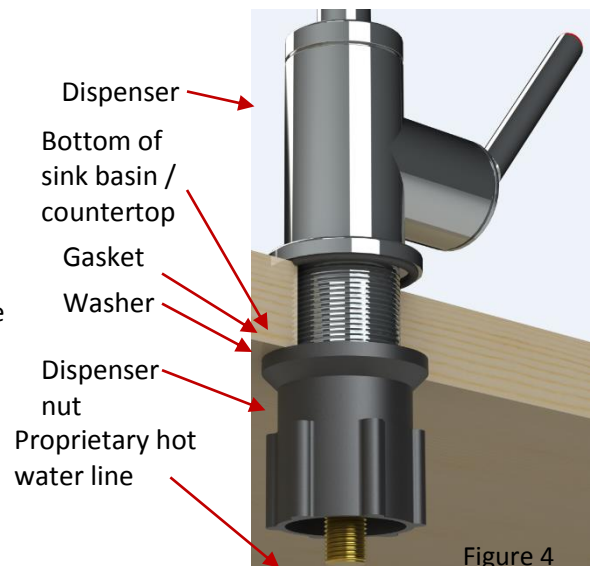



Figure 4

PLUMBING INSTALLATION INSTRUCTIONS

STEP 1: Thoroughly flush and check that all water lines are free of debris. Tighten the proprietary 20" 4 mm copper HOT WATER line that is connected to the dispenser to the OUTLET located on the **left** side of the heater when facing HotMax. Use the supplied ferrule and nut.

STEP 2: Connect the COLD WATER supply line to the 3/8" INLET fitting on the **right** side when facing HotMax.

Properly seal all compression fittings. Be careful to not overtighten.

 **DO NOT** use pipe dope or Teflon tape on any fittings connected to the unit.

 **DANGER** Using a non-proprietary hot water outlet pipe could result in injury, expose the unit to leaks and damage, or produce incorrect outlet water temperatures.

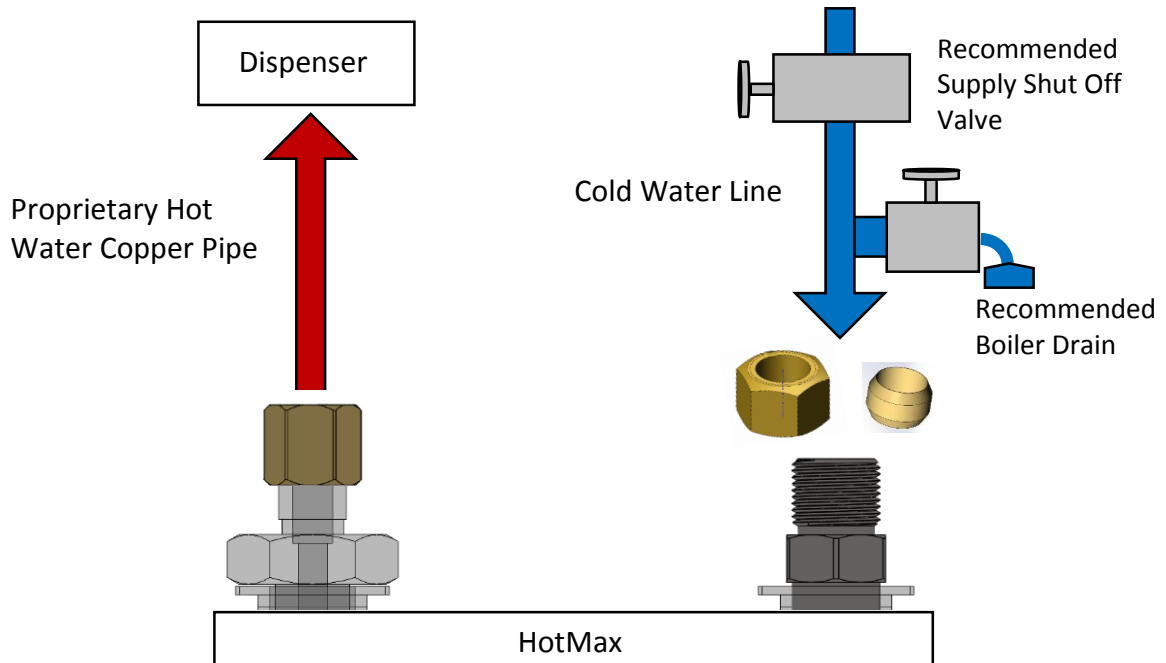

STEP 3: After tightening both fittings at the water heater, open the dispenser and let water run through the heater for at least 2 to 3 minutes. This process purges all the air from the water lines and **MUST** be performed prior to turning on the power at the unit. **FAILURE TO FOLLOW THIS STEP CAN CAUSE PERMANENT DAMAGE TO THE HEATING ELEMENTS.** If any maintenance is performed on the water heater or the plumbing system that may introduce air into the plumbing pipes, it is important to turn the power off to the water heater and purge the air out of the lines before allowing the unit to power up.

STEP 4: Carefully inspect all connections, unions, and the pressure relief valve (if installed) for leaks.

STEP 5: TURN OFF THE DISPENSER BEFORE PROCEEDING TO ELECTRICAL INSTALLATION

IMPORTANT NOTES:

1. We recommend a metallic brass drain, tailpiece and p-trap as plastic (PVC) cannot withstand temperatures greater than 140 °F.
2. Do not solder any pipes with the unit connected to pipes – heat from soldering may damage the flow sensor. Doing so will void the warranty.
3. This automatic tankless water heater is equipped with both computer-controlled and electro-mechanical auto resetting thermostat switches for high-limited temperature protection. Since this product does not use a storage tank, the use of a temperature pressure relief valve (T&P) is not required for most installations. UL Standard 499 does NOT require that a pressure relief valve be used. However, a T&P valve may be required to meet installation codes in your area. If one is required, install the pressure relief valve in accordance with local codes and ensure that it operates correctly and that air is purged from the valve prior to installing the water heater. When connecting to Flex or High Temperature CPVC pipe, we recommend that a T&P valve be used for added safety.
Please note: Installations in the Commonwealth of Massachusetts and State of Kentucky require a pressure relief valve. Please check your local installation codes for any special requirements.
4. The maximum system water pressure is 150 PSI (1035 kPa). Minimum operating water pressure 35 psi. Optimum operating water pressure 45 to 80 psi. If the water pressure is higher than 80 psi, a pressure reducing valve must be installed on the main incoming water supply line prior to installing the electric tankless water heater.
5. Only install the proprietary hot water tube that is included between the dispenser and heater. During installation, it is recommended that when connecting the inlet water pipe to the unit, make sure to use a wrench to hold the unit's connection, and another wrench to tighten, so that the flow sensor on the unit will not be loosened or damaged. Serious internal damage to the water heater can occur if the inlet or outlet connections are over tightened or if solder connections were made.
6. We recommend that a manual shut-off valve is installed on the inlet of the water heater so that there is a convenient shut-off point available in the event that future maintenance or servicing is required. This valve will also be used to reduce the flow rate if necessary. It is extremely important to flush the lines to eliminate all plumbing paste or residue in the lines caused by any welding or soldering before connecting pipes to the water heater.

We recommend that all the water pipes or hoses within 3' (1m) of the inlet and outlet connections be rated for high temperature applications with a 150°F (66°C) minimum.

 **CAUTION** Do not use pipe dope or Teflon Tape on any compression fittings on the unit or outlet hot water tube. Doing so may cause serious safety hazards or increase the risk of leaks.

 **WARNING CHECK FOR LEAKS BEFORE PROCEEDING TO ELECTRICAL INSTALLATION**

 **WARNING** This product is not recommended for anything besides its intended use as described in these instructions. Attachments not recommended by the manufacturer can cause safety hazards.

 **WARNING VERIFY THAT YOUR GARBAGE DISPOSAL IS CAPABLE OF WITHSTANDING TEMPERATURES UP TO 200°F PRIOR TO DISPENSING THE HOTMAX INTO ANY DRAIN EQUIPPED WITH A GARBAGE DISPOSAL**

5- ELECTRICAL INSTALLATION

⚠ WARNING Manufacturer recommends that this product be installed by a licensed and qualified electrician in accordance with all applicable national, state, provincial, and local electrical codes. As with all electrical appliances, under no circumstances should you attempt to install, repair or disassemble this water heater without first shutting off all power to the unit directly at the fuse or breaker box. **Make sure to shut off all breakers. SERIOUS BODILY INJURY OR DEATH COULD OCCUR IF YOU IGNORE THIS WARNING.**

All wiring (wire gauge) and circuit protection (breakers) must comply with the U.S. National Electrical Code (NEC) in the USA, or the Canadian Electrical Code (CEC) in Canada. Failure to do so could result in property damage and/or personal injury, and void your warranty. Note: The Canadian Electrical Code generally requires that all supply wires and corresponding circuit protection used for domestic hot water heating and hydronic heating applications be sized to a minimum of 125% of the maximum current rating of the heater (see heater specifications below for details).

Before installing this product, ensure sufficient electrical power is available to handle the maximum amperage load of the applicable heater.

IMPORTANT NOTES:

HotMax (13 kW) Recommended Wire Size:

- 6 AWG conductors
- 8 AWG ground

Manufacturer Recommends 240 VAC Single Phase

- 220 VAC may be used at a 15% reduction in power output
- 208 VAC may be used at a 20% reduction in power output

Please see electrical specifications by heater input and wiring diagram on the next page for additional electrical information.

⚠ WARNING

Wires must be connected to its own individual double pole breaker.

Installation Instructions

STEP 1: Make sure all electrical power is shut off. Remove the cover by unscrewing the 1 screw on the bottom tab of the unit. Using a flathead screwdriver, loosen the bottom two flathead screws in the white terminal block located at the bottom right hand corner of the unit. Feed an 6 AWG conducting wire pair through the electrical strain relief and into **Line 1** and **Line 2** of the terminal block (Figure 5). Make sure that the breaker is connected with one **red wire (Line 1)** and one **black wire (Line 2)**. Strip wire ends and ensure all wiring is properly secured through the electrical strain relief located at the bottom right when facing the unit. Tighten the two Philipshead screws on the electrical strain relief and the two flathead screws in the terminal block (Figure 5).

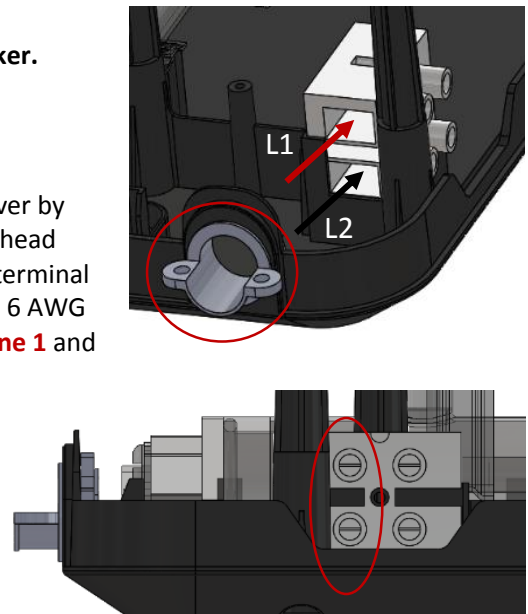

Figure 5

STEP 2: Using a suitable wire gauge that meets all applicable electrical codes for the size of the breakers used, connect the 6 AWG wire pair to the correct set of wires from the location's main breaker panel.

STEP 3: A separate 8 AWG **ground (green wire)** conductor for the incoming circuit is required. Route the **ground** wire along the same path as **Line 1** and **Line 2**. Using a Philips head screwdriver, tighten the **ground** wire to the ground lead.

STEP 4: Use a flat head screwdriver to **DOUBLE CHECK** the electrical connections to make sure they are correct and that all wire connections are tight and secure. Pull on wires to ensure that they do not pull out of their connections. Also confirm that the correct breaker size and wire gauge has been used and confirm that the unit has been connected to a ground in accordance with applicable codes.

STEP 5: Be sure to install the front cover back on the unit before turning on power to the unit. Confirm that all the air has been purged from the water lines prior to turning on power to the unit. Refer to STEP 3 in the plumbing installation section.

⚠ DANGER Failure to do so can result in property damage, injury or death.

⚠ CAUTION Ensure that you have made the correct connections. You must follow the wire connection as shown to ensure proper operation of the unit. If you mix up one set of wires with another, the unit will not operate correctly even though it turns on and otherwise appears to function properly.

The water heater is now installed and ready to use! Follow the General Operating Instructions to complete the setup.

Electrical Specifications by Heater Input

HEATER INPUT	13kW
ELEMENTS	2
VOLTAGE	240 VAC Single Phase
MAX kW	13 kW
kW PER ELEMENT	6.5 kW
MAX AMPERAGE DRAW	54 AMPS
REQUIRED BREAKERS	1 x 60 AMP (Double Pole)
REQUIRED WIRE GAUGE	2 x 6 AWG

CAUTION

TO PROVIDE CONTINUED PROTECTION AGAINST RISK OF ELECTRIC SHOCK, CONNECT ONLY TO A PROPERLY GROUNDED CIRCUIT. INDOOR USE ONLY. CONNECT ONLY TO A CIRCUIT THAT IS PROTECTED BY A RECOGNIZED GROUND-FAULT CIRCUIT INTERRUPTER (GFCI).

Wiring Diagram

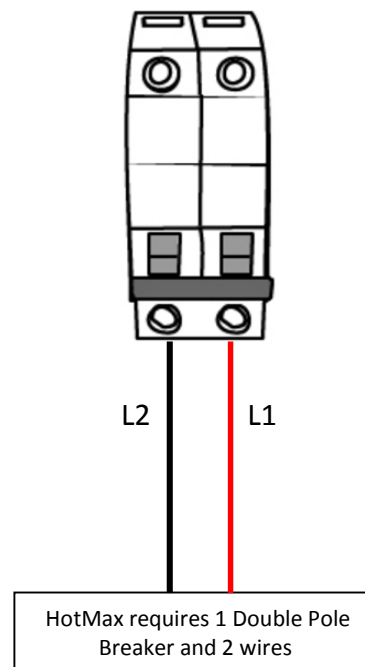

6- GENERAL OPERATING INSTRUCTIONS

Operating your new tankless water heater is similar to using any traditional water heating system. However, HotMax endlessly produces near boiling hot water instantly without dropping in temperature over time so it is very important that you carefully read all of the setup procedures and operating instructions and tips to ensure the maximum performance and energy savings from your new water heater. We recommend that all members of the household read these General Operating Instructions.

How your new water heater works: Your tankless water heater does not store hot water like a conventional tank-type water heater. It contains heating elements that are capable of heating water to near boiling temperature on-demand. As soon as you turn on a hot water dispenser, a sophisticated flow sensor recognizes that you have turned on the water. This sensor measures flow rate while another sensor measures the incoming water temperature. This information is transmitted continually to the computer logic controls which decide how much power to send to the heating elements to heat the water to your desired temperature. Once the water dispenser is turned off your water heater will turn off as well.

⚠️ WARNING Scalding Hazard: The dispenser delivers near boiling 210°F (99°C) water which can instantly burn or scald a person. Use care when operating this appliance.

NOTICE: If HotMax is installed at high altitudes, water will boil at lower temperatures. Turn down the set point on the heater to compensate for this high altitude.

Hot Max
 Endless Near Boiling Hot Water
 Turn knob clockwise to increase temperature in 5 °F increments. Maximum temperature = 200 °F



Water Quality: Quality of water should be taken into consideration when installing and maintaining the water heater. Water conditions outside the recommended levels outlined below are not permitted and can damage the water heater. Manufacture reserves the right to deny any warranty claim regarding damage suffered due to use in water conditions not in accordance with the table below.

If water heater is installed in an area that is known to have hard water in excess of 10 Grains per gallon, which may cause scale build-up, the water must be treated and/or the heater exchanger flushed regularly to prevent damage to heat exchanger and/or heating elements.

A water treatment device such as a scale inhibitor or water softener should be installed on the cold water feed to maintain optimal performance of the water heater in hard water areas. Contact customer service for additional information on these accessory kits.

Chart for Recommended Water Quality Levels									
pH	Total Dissolved Solids (TDS)	Free Carbon Dioxide (CO2)	Total Hardness	Aluminum	Chloride	Copper	Iron	Manganese	Zinc
6.5 - 8.5	Up to 500 mg/L	Up to 500 mg/L	Up to 200 mg/L	0.05 to 0.2 mg/L	Up to 250 mg/L	Up to 1.0 mg/L	Up to 0.3 mg/L	Up to 0.05 mg/L	Up to 5 mg/L

7- MAINTENANCE

To ensure maximum performance of your water heater and to reduce the risk of a water leak, we recommend the following maintenance:

Remove the Eemax Steam Shield™ steam separating aerator (Patent Pending) once a month and soak in white vinegar to descale any buildup. Perform this maintenance more often in heavy use or if the supply water is very hard (hardness > 11 GPM). **FAILURE TO DO SO CAN CAUSE HAZARDOUS OPERATION – SERIOUS BODILY INJURY OR DEATH COULD OCCUR IF YOU IGNORE THIS WARNING.**

Inspect the connections on the inlet and outlet of the water heater as well as the dispenser at least on an annual basis for any signs of damage or failure. Any signs of damage, cracks, leakage or weakness should be addressed. Take care not to over tighten the connections. Serious internal damage to your water heater can occur if you over tighten the water heater connections at the unit. Check to make sure there are no signs of corrosions or leaks around the dispenser mount or connections.

IMPORTANT NOTES:

 **DANGER** As with all electrical appliances, under no circumstances should you attempt to install, repair or disassemble this water heater without first shutting off all power to the unit directly at the fuse or circuit breaker. **SERIOUS BODILY INJURY OR DEATH COULD OCCUR IF YOU IGNORE THIS WARNING.**

When any maintenance is performed on the water heater or the plumbing system that may introduce air into the plumbing pipes, it is important to turn the power off to the water heater and purge the air out of the lines before allowing the unit to power up. **FAILURE TO DO SO COULD CAUSE PERMANENT DAMAGE TO THE HEATING ELEMENT AND VOID YOUR WARRANTY.**

If you have a water supply with a high level of mineralization (hard water), you should increase the frequency of your maintenance.

“CAUTION”

Before servicing the unit make sure to disconnect the power supply connection directly at the breaker. REQUIRED WIRING #6, USE 1X60AMP CIRCUIT BREAKERS.

8- TROUBLE SHOOTING GUIDE

Are you having problems with your water heater?

Please call or email our customer service and technical support team for any help you may need.

TOLL FREE 1-(800) 543-6163 Email: Support@eemaxinc.com

The following table represents some of the most common technical support questions we receive. Before calling us, please read thoroughly to see if your question or problem is addressed.

PROBLEM	POSSIBLE CAUSE	SOLUTION
Water heater is not heating at all (water is flowing but the unit is not heating - the outgoing water temperature is the same as the cold water supply)	No power or incorrect wiring.	Make sure the breakers at main electrical panel are ON. You may have a faulty breaker or unit may be wired incorrectly.
	Flow rate is too low / water pressure is too low.	Your water heater has an activation flow rate of approximately 0.3 GPM (1.1 LPM). If your water flow rate is less than this level, your unit will not activate. Increase the flow rate. Reduce or remove restrictions upstream of
	Internal part failure.	Please call us for technical assistance.
Water heater is heating, but the water temperature is not hot enough.	User temperature setting too low.	Turn up the temperature setting on the unit.
	Flow rate is too high.	Your water flow rate may exceed the physical heating capacity of your water heater. The optional flow rate for HotMax is between 0.4 and 0.6 gpm. Reduce the flow rate or install a Flow Regulator.
	Crossed wires.	If it's a new installation, have your electrician double check the wiring. Is possible that the wiring is incorrect.
	Voltage less than 240 volts.	The heating elements on your water heater are design for 240 volts. When used with a lower voltage, they produce less heating power. Make sure there is sufficient voltage for your heater.
The water temperature at the dispenser is less or greater than the temperature setting of my water heater.	Voltage less than 240 volts.	The computer chips in your tankless water heater are programmed with the expectation that your incoming line voltage is 240 volts. If you have less than 240 volts, it may affect the reading on your water heater's digital display and cause it to read slightly higher than the actual output temperature. To compensate for this, increase the setting on your water heater if you need / want hotter water.
	Anti-Scald pressure/balancing valve or tempering valve.	HotMax is intended to produce water temperatures greater than 140°F (60°F). Your dispenser should not have an anti-scald feature or a tempering valve that automatically mixes cold water even when you turn your control lever or handle to full hot. These devices prevent HotMax from operating.
	Thermal loss due to long pipe run	The proprietary outlet pipe/tube should be the only outlet for hot water from the heater to the dispenser. Any other hot water delivery system could result in heat loss especially if it has long distance to travel or the pipes are cold. If the correct pipe is installed, adjust the temperature setting on your water heater if you need/want hotter water.
	Water temperature at the dispenser is too hot	Check your flow for too little flow, set point temperature is too high, or internal part failure. Call us for technical assistance.
Water spits/sprays/drips from dispenser	Possible damage to the dispenser or proprietary Steam Shield aerator	Check and tighten fittings to ensure that there is a good connection. If the problem continues, please call us for technical assistance.
	Steam Shield aerator has scale deposits	Remove and soak Steam Shield aerator in vinegar or descaling solution overnight
	Steam Shield aerator is clogged	Remove aretor and remove any obtructions clogged in the screen. Backflush with water if necessary.

9- USER INTERFACE

HotMax Features:

HotMax is designed for a flow rate of 0.5 gpm. An acceptable range is 0.4 – 0.6 gpm. Flow rates outside this range will negatively impact the outlet water temperature and the flow pattern from the dispenser.

The temperature control knob adjust water temperature in increments of 5°F

- Turning the knob clockwise increases the set output water temperature
- Turning the knob counter clockwise decreases the set output water temperature
- You can set or adjust the temperature at any time between 140°F – 200°F (60°C – 99°C). The temperature can be changed to your desired setting.

HotMax will fill an 8 oz cup or measurement cup in 7.5 to 8 seconds with near boiling hot water.



DANGER Hotter water increases the potential for Hot Water SCALDS



CAUTION Removing the cover while the unit is energized or hot exposes electrical shock and burn hazards, which can cause INJURY or DEATH. Adjustment should only be done by a licensed plumber or electrician.

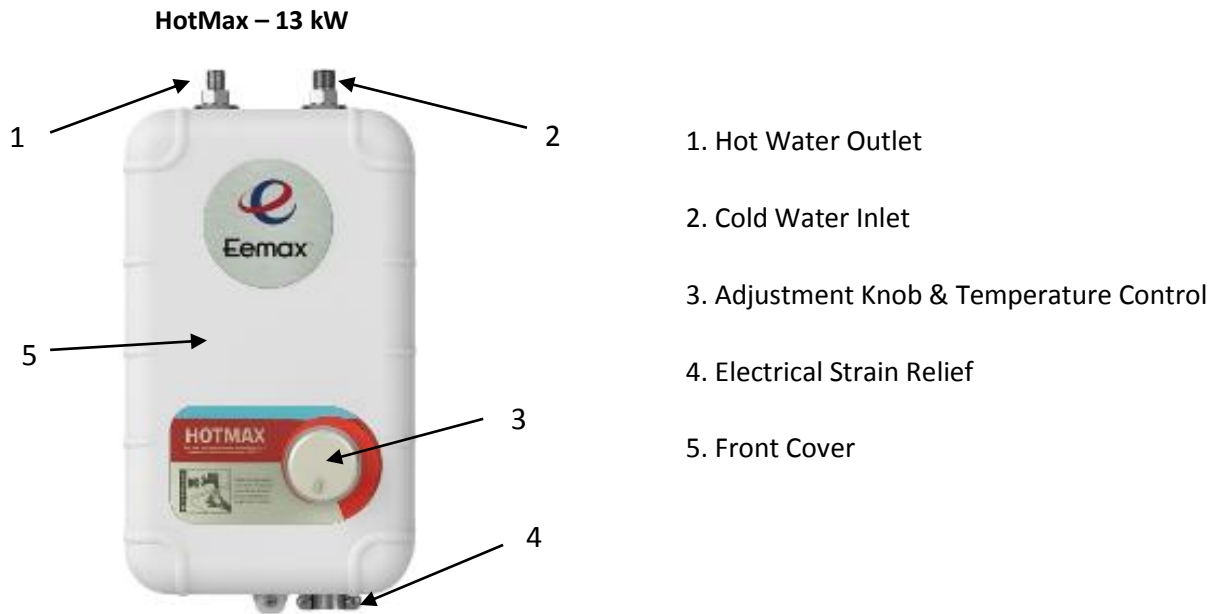

Input	Height in(mm)	Width in(mm)	Depth in(mm)
13 kW	11.5 (292.1)	8 (203.2)	3.75 (95.25)

