

Encore[®]

Encore Plug-in Heat Pump Water Heater (120V Dedicated Circuit)

EFFICIENCY

- Up to 3.0 UEF reduces operating cost
- ENERGY STAR[®] rated

PERFORMANCE

- Ambient operating range: 37-145° F is widest in class designed to meet Northern Climate Spec (Tier 2)

EASY INSTALLATION

- Easy access side connections
- Factory installed plug-in power cord, direct plug-in
- Easily replaces a standard gas water heater

INTEGRATION

- LED display allows easy control and system monitoring with alerts and audible alarms¹



- Integrated EcoNet[®] WiFi-connected² technology and free mobile app gives users control over water heater, allowing for customizable temperature, vacation settings, energy savings and system monitoring at home or away
- LeakGuard[™] and LeakSense[™] Ready – Easily add leak detection and prevention with leak sensor and shutoff valve upgrade kit
- Demand Response Ready – Built-in EcoPort[™] (CTA-2045 Port) allows easy connection to Utility programs

OPERATION MODES

- Heat Pump
- Vacation/Away: 2-28 days (or placed on hold indefinitely)

PLUS...

- Premium grade anode rod with resistor extends the life of the tank
- 3/4" NPT water inlet and outlet; 3/4" condensate drain connections
- Easy access, top mounted washable air filters
- 2" Non-CFC foam insulation
- Enhanced flow brass drain valve
- Temperature and pressure relief valve installed
- Design certified to NSF/ANSI 372 (Lead Content)

WARRANTY

- 10-Year limited tank and parts warranty
See Residential Warranty Certificate for complete information

Units meet or exceed ANSI requirements and have been tested according to D.O.E. procedures. Units meet or exceed the energy efficiency requirements of NAECA, ASHRAE standard 90, ICC Code and all state energy efficiency performance criteria.



Encore Plug-in Heat Pump
(120V Dedicated Circuit)
40 and 50-Gallon Capacities
120 Volt / 1 PH
Electric



These products meet a stringent set of our internally defined sustainability standards.



LEED Points = 3

¹Requires additional leak sensing accessory. ²WiFi broadband internet connection required.

See specifications chart on next page.

Plug-in Heat Pump Specifications

DESCRIPTION					ENERGY INFO	FEATURES				TANK DIMENSIONS (SEE SPACE REQUIREMENTS IN DIAGRAMS BELOW)			
NOMINAL GALLON CAPACITY	RATED GALLON CAPACITY	MODEL NUMBER	ELECTRIC BREAKER SIZE (TIME DELAY)	VOLTAGE	UNIFORM ENERGY FACTOR (UEF)	COMPRESSOR BTU/H	SOUND LEVEL (dBA)	UEF FIRST HR. RATING G.P.H.	RECOVERY IN G.P.H. 60° F RISE	HEIGHT A	DIAM. B	UNIT WT. (LBS)	APPROX. SHIP WT. (LBS.)
40	37	10E40-HP120	15	120V	3.0	12,000	55	51	28	65-5/8	20-1/4	200	242
50	46	10E50-HP120	15	120V	3.0	12,000	55	51	29	65	22-1/4	210	252

Uniform Energy Factor and rated gallon capacity based on Department of Energy (DOE) requirements.
All units have integrated WiFi control board.

INITIAL TANK TEMP (°F)	FINAL TANK TEMP (°F)	HEAT UP TIME (MIN)
40	120	91.1
50	120	83.7
58	120	77.4
70	120	67.1
87	120	51
100	120	37.2

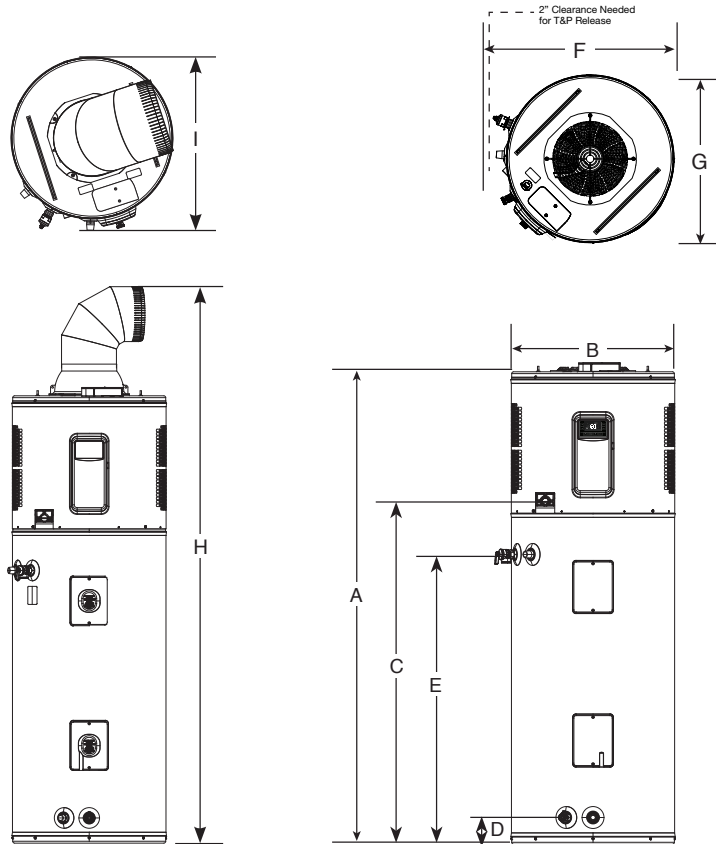
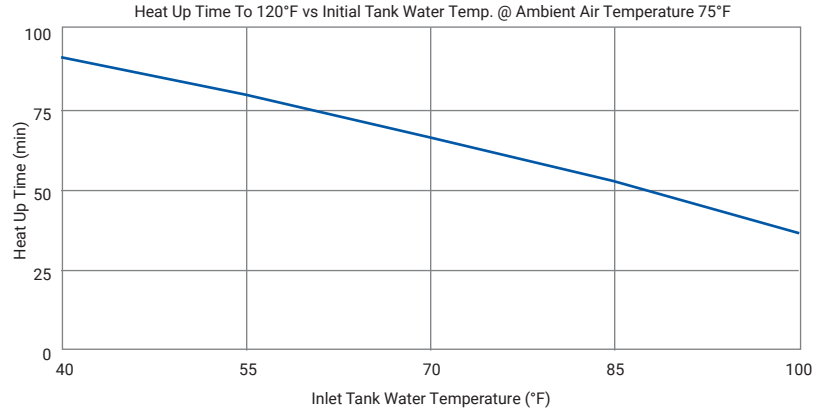

Insulate ducting to reduce condensation.

DESCRIPTION		DIMENSIONS (SHOWN IN INCHES)								
NOMINAL GALLON CAPACITY	MODEL NUMBER	A	B	C	D	E	F	G	H	I
40	10E40-HP120	65-5/8	20-1/4	47-13/16	3-5/8	39-5/8	23-3/8	20-1/2	81	21-3/4
50	10E50-HP120	65	22-1/4	47-1/4	3-5/8	39-5/8	25-3/8	22-1/2	80-3/8	21-3/4

Plug-in Heat Pump (Dedicated Circuit Water Heater Installation Guidelines to Provide Optimal Efficiency

All volume is cubic feet.

Not Ducted

Room size: Larger than 1200 ft³ (e.g. 12' x 10' x 10').

Requirements: No additional ventilation needed.

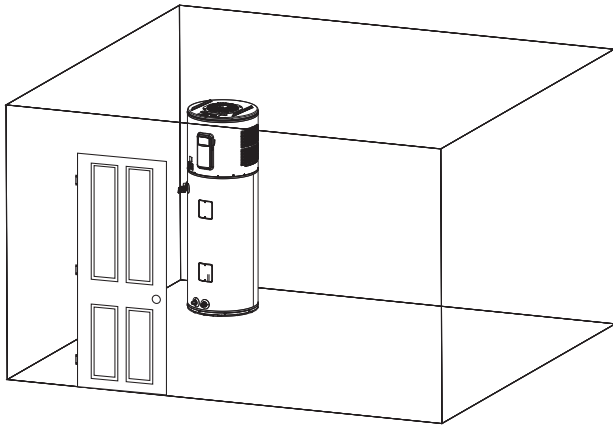

Not Ducted

Room size: 400 ft³ (e.g. 5' x 8' x 10') to 1200 ft³ (e.g. 12' x 10' x 10').

Requirements: Full louvered door OR two louvers top and bottom. 2.9 ft² minimum louver area.

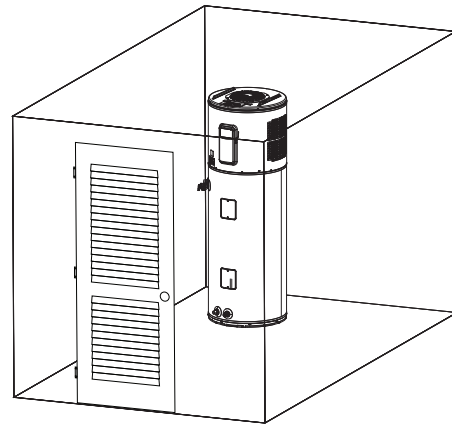

Ducted with outlet duct

Room size: Smaller than 400 ft³ (5' x 8' x 10') such as a closet.

Requirements: Full louvered door. 3.25 ft² minimum louver area.

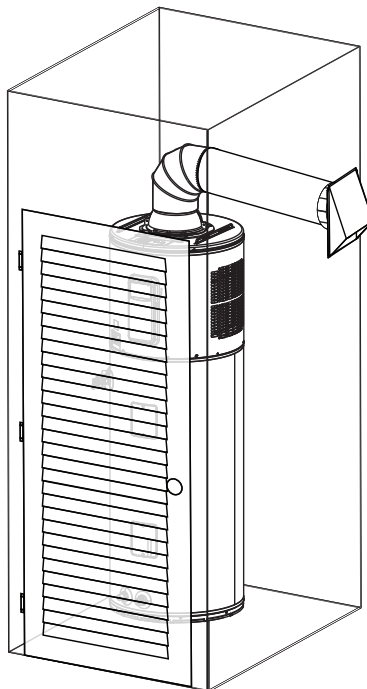

Insulate ducting to reduce condensation.

Insufficient air circulation may result in an ambient air temperature drop more than 15° F (8° C) and inefficient operation. Refer to the room size volume illustrations to determine optimal installation and if exhaust should be ducted.

Installation Space Volume is the unoccupied, free air space required for optimal operation. Additional objects occupying the space reduce total space volume.

For optimal operation, installation in gray US map zone is recommended. When installing outside of gray zone, consult your local plumbing contractor.

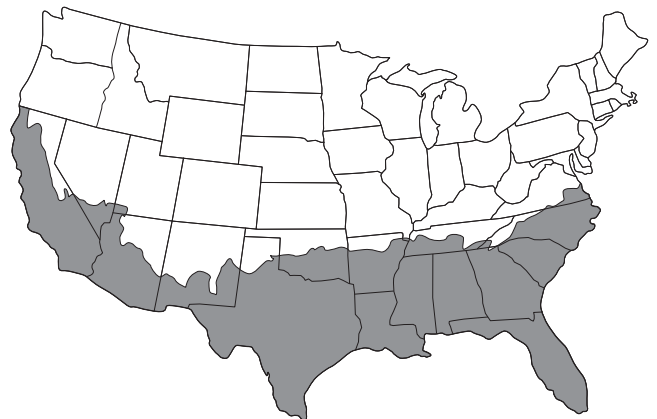

Average Ambient Air Temp in January

- Below 37°F
- Above 37°F

MINIMUM CLEARANCES (WITHOUT DUCTING)		
REAR	SIDES	TOP
0"	3"	9"

Encore®

Plug-in Heat Pump Accessories List

PART NUMBER	DESCRIPTION	USE FOR
AP18944D	Leak Sensor	Automatic detection of internal and external leaks
AP20180	Shutoff Valve	Automatic shut off of water supply to unit
AP21851	Inlet Duct Adapter	Allows for ducting to be connected on the top inlet
AP17829	Outlet Duct Adapter	Allows for ducting to be connected to the unit
SP20882	Earthquake Isolation Kit	Installations in seismic regions
SP20883	Vibration Isolation Kit	Installation on non-concrete floors
SP20884	8" Diameter UL Certified Termination Kit	Termination to the outside or to the attic with 8" diameter
SP20885	7" Diameter UL Certified Termination Kit	Termination to the outside or to the attic with 7" diameter
SP20886	6" Diameter UL Certified Termination Kit	Termination to the outside or to the attic with 6" diameter
SP20887	5" Diameter UL Certified Termination Kit	Termination to the outside or to the attic with 5" diameter
SP20888	8" Richmond Approved Damper Kit	Exhaust only to the outside ducting configuration (no inlet duct)
SP20889	25' Flexible 8" Diameter Duct Kit	For up to 25' of ducting
SP20890	Rigid Elbow Duct Kit	Installation in tight places where space needs to be minimized
SP21111	Leak Sensor & Shutoff Valve Kit	Upgrade models to protect home from water damage with leak detection and auto shutoff valve

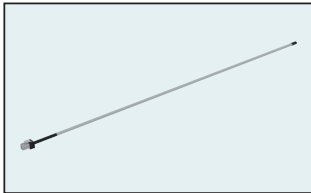

AP18944D



AP20180

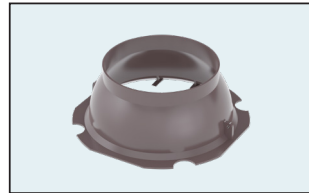

AP21851

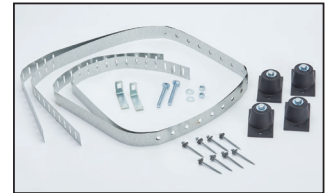

SP20882



SP20883

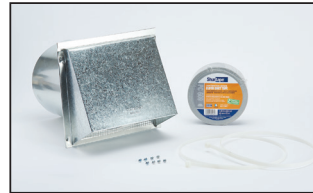

SP20884



SP20885



SP20886



SP20887



SP20888



SP20889

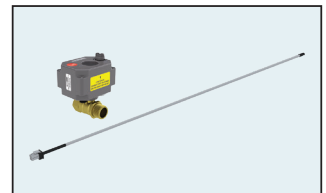

SP21111

UPGRADE KIT (for Encore models without LeakGuard only)
 - Add leak detector and shutoff valve to protect from water damage